

Complete Thermal System Solutions for Plastics Processing





Tradition of Excellence

Watlow® provides the plastics industry with product innovations for injection molding, hot runner systems, extrusion, blown film, thermoforming and blow molding. We understand how vital selecting the right auxiliary equipment can be in helping a plastics processor meet a goal of higher productivity and greater yield. It goes beyond the costs of heaters, sensors or controllers; it is performance that counts.

Quality, innovation and reliability are the hallmarks of our family of electric heaters, temperature sensors and controllers. Watlow provides not only traditional thermal solutions, but also innovative, high-performance technologies to meet the specific processing demands of industries that require highly-engineered resins and tight tolerances.

Watlow meets your thermal solution needs with our broad product offering, new technologies, engineering services and global manufacturing capabilities.



Watlow sales engineers provide the support plastic manufacturers need.

Global Manufacturing and Sales Support

To better serve the plastics industry, Watlow operates 13 manufacturing facilities and over 40 technical support centers in Asia, Europe and North America. As a global company, we support international design guidelines and agency approvals. We have hundreds of factory-trained sales engineers, each with an average of 15 years of experience, and distributors located throughout the world.

We invite you to blend the thermal expertise of our sales engineers with the existing capabilities of your engineering team. Our sales engineers are available to complement your team at any stage of your project from concept through prototyping and beyond project completion - one more way Watlow can help you build distinct performance advantages.

Table of Contents

Injection Molding.....	1	Thermoforming.....	4
Extrusion/Blown Film	2	Heater Solutions.....	5
Blow Molding	3	Controller and Sensor Solutions	8

Injection Molding

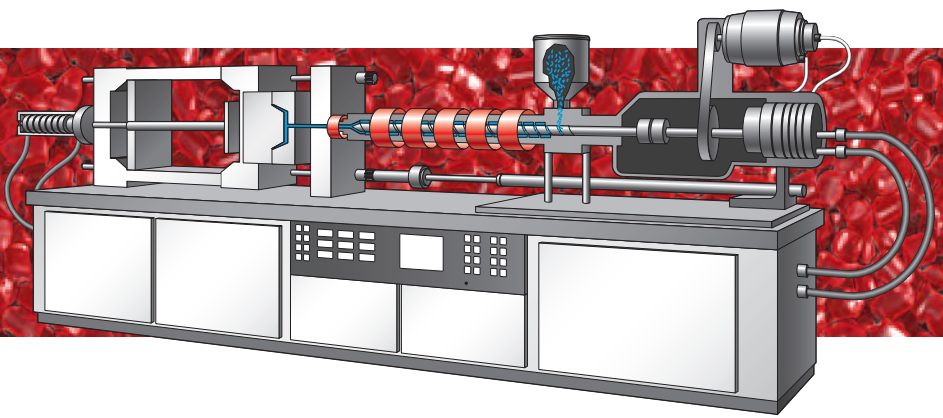

Watlow's history is highlighted with numerous innovations and thermal expertise in the plastics industry. The first to patent the cartridge-style heater in 1954, the tradition continues with new patented manufacturing technologies. Watlow also has experience in thermal system development with expertise in finite element analysis (FEA). This allows molders to optimize the thermal profile of their molds and the internal wattage distribution of heaters to insure that the most favorable patterns are realized. Regardless of your injection molding system, Watlow's thermal solutions provide the high-performance, reliability and accuracy needed to optimize your process.

Applications Watlow serves include:

- Agricultural equipment
- Aircraft, aerospace
- Automotive
- Building and construction
- Communications equipment
- Computer, business and office equipment
- Consumer products
- Containers and closures
- Electrical, electronics
- Foodservice, institutional products
- Furniture, fixtures
- Medical, dental equipment
- Personal care products
- Recreation, toys and sporting goods
- Small appliances, hand tools
- Packaging
- Transportation

Whether you require high performance, high temperature, high watt density, or all of these, Watlow has the product to best fit your application:



- Barrel heaters
- Cable heaters
- Cartridge heaters
- Hot runner nozzle heaters
- Hot runner manifold heaters
- Power controllers
- Temperature controllers
 - Single-loop
 - Multi-loop
 - Integrated
- Temperature sensors
- Data logging and trending software

For more than 50 years Watlow has provided thermal solutions for plastic applications.

Mineral Insulated (MI) Band Heater Case History

Problem:

A company needed to increase energy savings and reduce operations costs.

Solution:

Watlow's MI band heaters provide exceptional heat transfer, high watt densities and prolonged heater life. To improve efficiency, Watlow performed an energy assessment of Watlow's MI band heater versus the company's current mica heater solution. The MI band heater saved the company \$0.04 per kilowatt hour. This is a savings of over \$4,000 a year.



Extrusion/ Blown Film

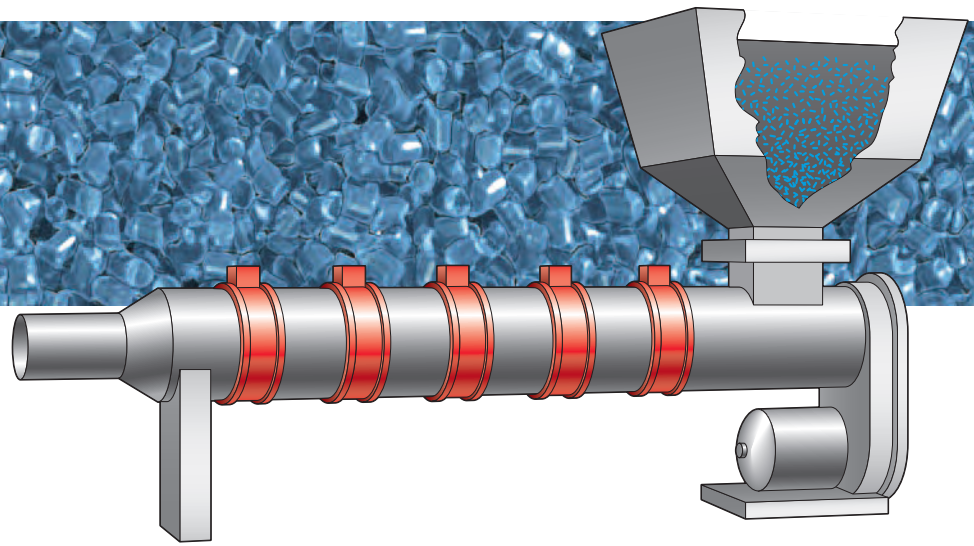
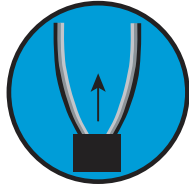

EZ-ZONE® ST Plastics Extrusion Equipment Case History

Problem:

A plastics extrusion manufacturer needed to increase data acquisition capabilities on their extrusion equipment. The engineering effort of new plastic compounds required a lot of intimate process control information. The project time required to bring the research and development center online was on a very tight schedule.

Solution:

The extrusion machine was specified to utilize 15 EZ-ZONE® ST integrated control loop products to control and monitor 15 zones. To meet the desire for process and equipment related data acquisition, the EZ-ZONE ST with digital communications capability was identified to provide a system performance data to a programmable logic controller (PLC). Since its integration into the system, the EZ-ZONE ST has offered greater reliability to monitor system relation information within the thermal control zone.



Product quality begins upstream, and Watlow's family of thermal solutions provides products that bridge the gap by providing product quality, assuring process repeatability and shortening overall startup time. Watlow provides thermal solutions for a wide array of extrusion applications.

Applications include:

- Blown film and cast film
- Profile, shapes and rods
- Flat sheet and web extrusion
- Wire and cable coating
- Pipe tubing and conduit extrusion

Watlow manufactures a variety of reliable, agency-approved heaters, sensors and controllers for your extrusion process equipment. Below is a list of Watlow's extrusion thermal solutions:

- Barrel heaters
- Sprue heaters
- Die and former heaters
- Power controllers
- Temperature controllers
 - Single-loop
 - Multi-loop
 - Integrated
- Temperature sensors
- Data logging and trending software



Plastic is heated in a barrel with Watlow heaters and then blown into film.

Blow Molding

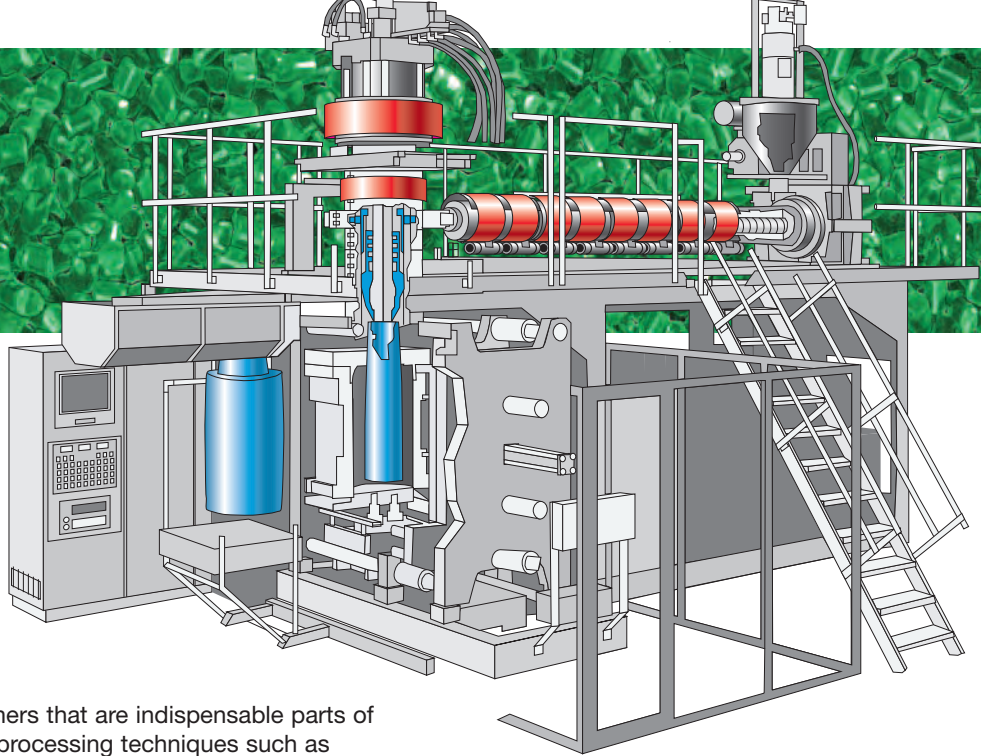

The art and science of making hollow plastic containers that are indispensable parts of everyday life are all part of blow molding. Common processing techniques such as extrusion, stretch blow, injection and co-extrusion are all utilized in forming these parts.

Applications include:

- Automotive components
- Double-walled cases and toner cartridges
- Food and beverage packaging
- Medical feeding containers
- Personal care products
- Household products
- Aggressive chemicals
- Sporting goods
- Toys

Whether it is a diverse and complex part that requires high performance such as an elastically functional automotive component; or a high volume hollow piece such as a single serve PET water bottle, the front-end blow molding process still requires an exacting thermal solution. Regardless of your resin choice or final part shape, Watlow has the following thermal solutions for your application requirements:

- Barrel and band heating
- Power controllers
- Communications
- Temperature controllers
 - Single-loop
 - Multi-loop
 - Integrated
- Temperature sensors
- Data logging and trending software



Watlow products play a critical role in the quality and productivity of PET processes.

FIREROD® Cartridge Heater Case History

Problem:

An original equipment manufacturer (OEM) was experiencing difficulty processing on its blow molding equipment. They decided to internally heat the screw of the extruder/gear-pump to optimize the performance of the line.

Solution:

Watlow heated the rod internally with a FIREROD® heater containing an internal thermocouple for temperature control. With this approach, approximately 50 percent or more of the energy imparted to the resin came from direct thermal conduction rather than mechanically induced friction. Additional benefits of the new design included lower melt temperatures, higher throughput capacity and improved gear pump energy efficiency.



Thermoforming

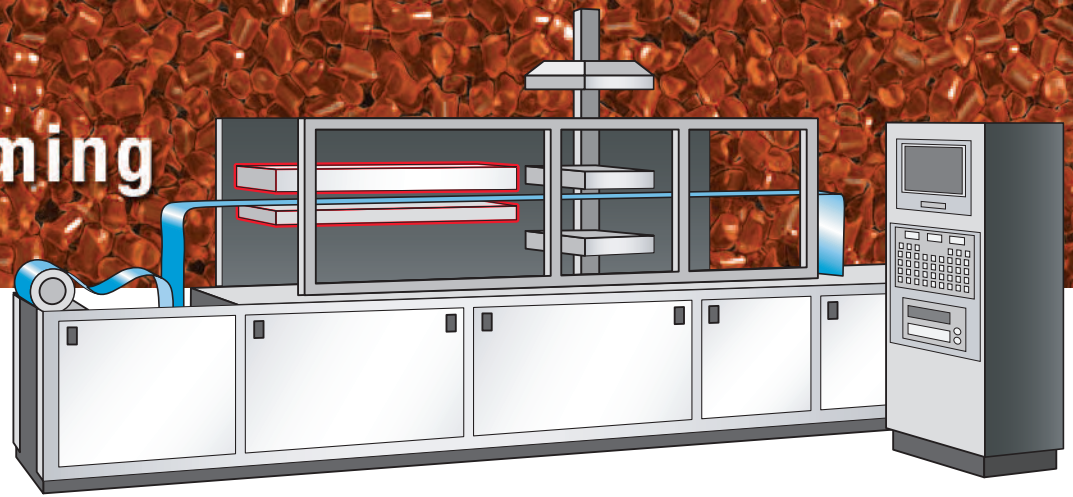

Radiant Heaters Make Thermoplastic Sheets Stampable Case History

Problem:

A customer utilized polypropylene-based, glass reinforced structural plastic in automobile front-ends, power mower shrouds, snow shovels, etc. The company needed a way to preheat the plastic with a low investment.

Solution:

Watlow's RAYMAX® 1120 radiant panel heaters were used to preheat the plastic sheet material, which was then conveyed to a die where the final configuration was conformed. RAYMAX 1120 heaters operated at a lower temperature than quartz tubes and emitted a greater percentage of infrared energy with minimal wavelength, for better penetration of the plastic material. The heater also met the need for even temperature heating. Watlow specified and designed a complete system within two weeks.

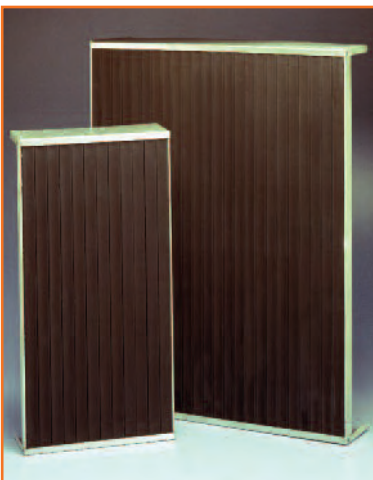

Thermoforming part design has developed rapidly and in recent years it has become more multifaceted. Because thermoforming offers advantages such as superior finished part quality and the ability to form large parts, processors are investing in larger and faster machines and expanding both upstream and downstream services.

Applications include:

- Vacuum forming
- High definition thermoforming
- Pressure assisted thermoforming
- Drape forming
- Press forming
- Line bending

Although thermoforming consists of a broad range of materials, material thickness and processing levels, Watlow can help optimize your process. Whether you require a sealed face heater to keep sheet/roll contaminants away from the element while offering ease-of-cleaning and longer life, or overall precise process control Watlow has the following thermal solutions for your thermoforming applications:

- Heaters
- Power controllers
- Temperature controllers
 - Single-loop
 - Multi-loop
 - Integrated
- Temperature sensors
- Data logging and trending software



Watlow's radiant heaters allow plastic to be heated quickly and uniformly.

Heater Solutions

Mineral Insulated (MI) Band Heaters



MI band heaters are constructed of Watlow's exclusive mineral insulation – a material with much higher thermal conductivity than the mica and hard ceramic insulators used in conventional heaters.

Performance:

- Operating temperatures to 760°C (1400°F)
- Watt densities to 35.6 W/cm² (230 W/in²) for nozzle heaters
- Watt densities to 15.5 W/cm² (100 W/in²) for larger barrel bands

Product Features:

- Higher watt densities than any other barrel heater, which contributes to faster heat-up and through-put to increase productivity
- High thermal conductivity of MI in a low mass construction gives almost instant response to temperature control
- Permanently attached clamp bars make installation easier by eliminating cumbersome clamping straps

Applications:

- Injection molding barrel heating
- Hot runner nozzle heating
- Extruder barrel heating
- Die and former heating
- Blow mold heating



Special Mica Band Heaters



Several specialty mica band heaters have been constructed over the last 50 years through solving complex and unique applications with Watlow's engineering expertise and experience.

Performance:

- Sheath temperatures to 480°C (900°F)
- Watt densities to 7.0 W/cm² (45 W/in²)

Product Features:

- Patented clamping strap assures heat transfer
- Low mass design allows fast heat-up and quick response
- Design variations provide user convenience and heater protection

Applications:

- Injection molding barrel heating
- Extruder barrel heating
- Hot runner nozzle heating

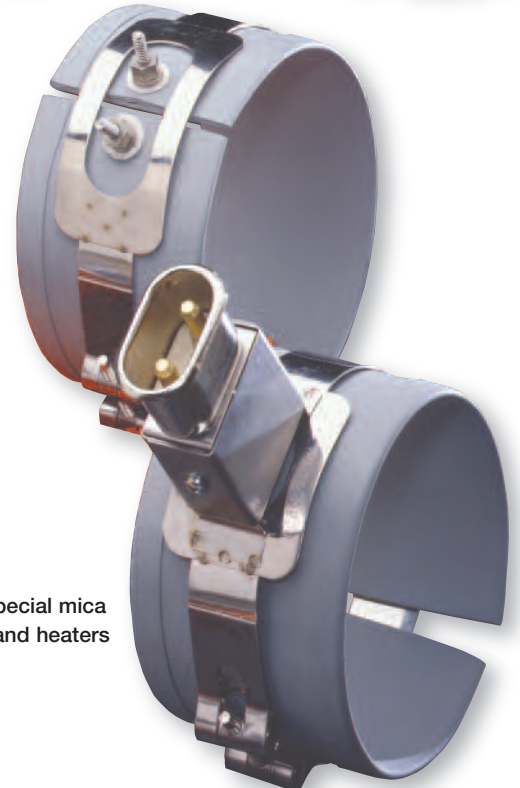

Heater Solutions

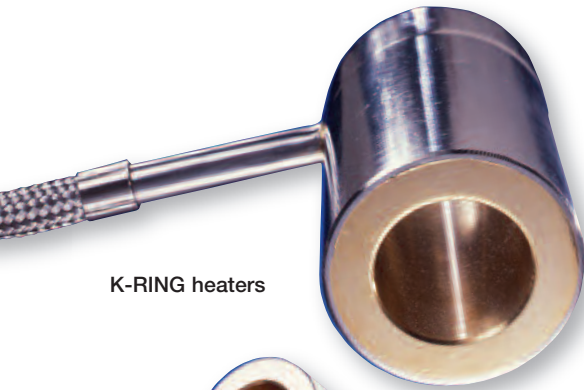

K-RING heaters

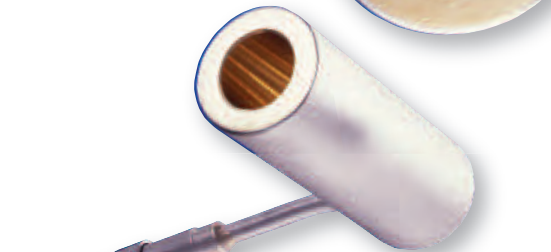

K-RING® Nozzle Heaters

Thanks to the innovative design, plastic molders no longer have to compromise with sloppy fit tolerances, uneven temperature profiles or short heater life. The metric K-RING® and mini K-RING heaters take nozzle heating technology a step ahead of the competition.

Performance:

- Operating temperatures to 650°C (1200°F)
- Watt densities to 50 W/cm² (320 W/in²) on inside diameter

Product Features:

- Brass casting construction protects heater from damage, as well as

maximizes transfer of heat to heated parts

- Precision machining of length and inside diameter gives accurate fit tolerances
- Sealed construction eliminates contamination and stainless steel outer casting protects the brass body, acting like an insulator

Applications:

- Hot runner nozzle heating
- Sprue heating
- Die and former heating



FIREROD cartridge heaters

FIREROD Cartridge Heaters

With premium materials and tight manufacturing controls, FIREROD heaters provide superior heat transfer, uniform temperatures and resistance to oxidation and corrosion even at high temperatures.

Performance:

- Operating temperatures to 760°C (1400°F) on Incoloy® sheath
- Watt densities to 62 W/cm² (400 W/in²)

Product Features:

- Nickel-chromium wire is precisely wound and centered in the unit assuring even, efficient distribution of heat to the sheath

Magnesium oxide insulation of specific grain and purity, swaged to the proper density, results in high dielectric strength and contributes to faster heat up

- Incoloy® sheath resists oxidation and corrosion from many chemicals and environments

Applications:

- Hot runner nozzle heating
- Hot runner manifold heating
- Die and former heating
- Blow molding heating



MI strip heaters

MI Strip Heaters

The Watlow MI strip is a thin, responsive heater that sets unmatched standards for performance and durability. It makes use of the most advanced heater construction techniques, including embedding a nickel chromium element wire in Watlow's exclusive mineral insulation.

Performance:

- Sheath temperatures to 760°C (1400°F)
- Watt densities to 15.5 W/cm² (100 W/in²)

Product Features:

- Higher watt densities than other strip heaters contribute to faster heat-up
- Exclusive mineral insulation combines high dielectric strength and superior thermal conductivity, which transfers heat rapidly to the sheath

Applications:

- Die and former heating
- Extrusion heating
- Thermoforming heating



Heater Solutions

Mica Strip Heaters

Watlow's mica strip heater is an economical and reliable source of heat for plastics equipment. A mere 15 mils (0.4 mm) thick mica insulator on both sides of the resistance element insulation and offers little resistance to efficient heat flow.

Performance:

- Sheath temperatures to 480°C (900°F) on zinc-coated units
- Sheath temperatures to 650°C (1200°F) on stainless steel units
- Watt densities to 8.5 W/cm² (55 W/in²)

Product Features:

- Flat resistance ribbon generates heat over a broad area, and puts the heat source closer to the work
- Low mass construction heats-up faster to provide quick response to control input
- Excellent dielectric strength is guaranteed

Applications:

- Die and former heating
- Thermoforming heating

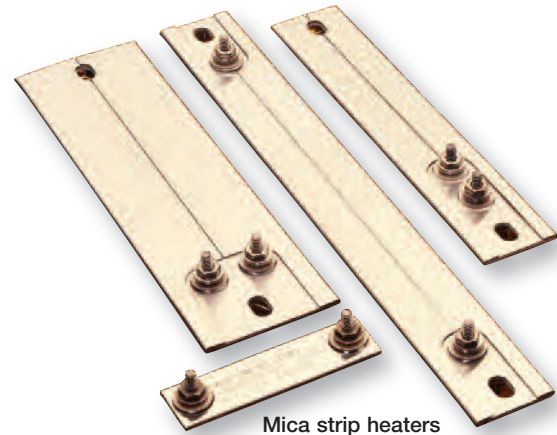

Mica strip heaters

WATROD Tubular Milled Groove Heaters

WATROD milled groove heaters provide the uniform heat required in hot runner molds. Watlow's WATROD tubular heaters are precision-formed and customized to your hot runner mold applications.

Performance:

- Sheath temperatures to 870°C (1600°F) for Incoloy[®]
- Watt densities to 15.5 W/cm² (100 W/in²)

Product Features:

- Formed to milled groove puts heat where it is needed most
- Precision-wound custom engineered resistance wire for evenly distributed heat, heater efficiency and reliability
- Incoloy[®] or stainless steel sheath for high-temperature and to retain shape

Applications:

- Hot runner manifold heating



Tubular milled groove heaters

Tubular Immersion Heaters

Mold temperature control is extremely important because the temperature of mold surfaces with which molten plastic comes into contact, changes as the room temperature changes. Watlow's tubular immersion heaters provide consistent mold control regardless of the season.

Performance:

- Sheath temperatures to 870°C (1600°F) for Incoloy[®]
- Watt densities to 15.5 W/cm² (100 W/in²)

Product Features:

- Quick delivery: same day shipment for stock units and next day shipment for assembly units
- Incoloy[®] or stainless steel sheath for high-temperature and to retain shape

Applications:

- Injection molding mold temperature control units



Tubular immersion heaters

Heater Solutions

RAYMAX Radiant Heaters



Watlow's diverse RAYMAX heater line fits virtually any plastics application requiring radiant heat. Watlow's capabilities cover a wide range of needs, from contamination-resistance surfaces, to fast-responding high temperature panels, to replaceable tubular elements.

Performance:

- Operating temperatures to 930°C (1700°F) for quartz radiant heaters
- Operating temperatures to 700°C (1300°F) for panel radiant heaters

Product Features:

- A full line of RAYMAX heaters includes panel and quartz tube styles with capabilities to match the ideal temperature and watt density requirements of your application
- Fast delivery on all standard replacement parts, which decreases downtime

Applications:

- Thermoforming
- Blow mold heating



RAYMAX radiant heaters

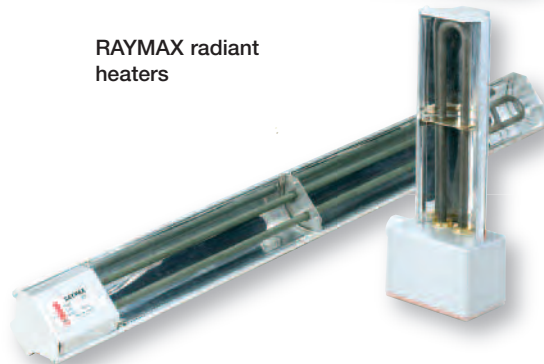

Controller Solutions

EZ-ZONE PM



Single-loop Temperature Controllers

Agency-approved Watlow single-loop, auto-tuning temperature controllers automatically set PID control parameters for optimum system performance. Manual settings also permit on-off, P, PI or PID control modes.

Product Features:

- Integrated PID limit controller
- High amperage power controller with serial communications capabilities

Applications:

- Injection molding
- Blow molding

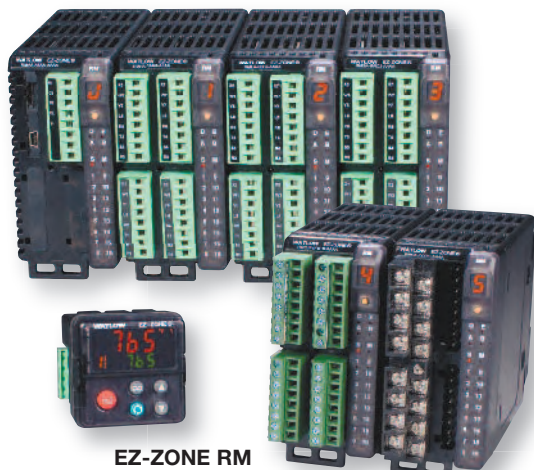

EZ-ZONE RM

Multi-loop Temperature Controllers

Each time/temperature controller offers a wide range of I/O options with exceptional accuracy. Inputs can be multiple and mixed, including thermocouple, RTD and process.

Product Features:

- Allow many common controller platforms across many applications and functions
- Versatile alarms, serial communications and remote operation or data logging

Applications:

- Injection molding
- Thermoforming



Controller Solutions

Integrated Controllers

PID temperature controllers offering you the ability to utilize just one component with advanced designs giving you the ability to add or subtract modules as your requirements change.

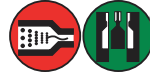

Product Features:

- Offers complete thermal system control in a single package solution
- Offers solid state relay output

Applications:

- Injection molding
- Blow molding

EZ-ZONE ST



Power Controllers

Watlow stocks over 20 different solid state relays and heat sinks that customers can match to their specific application with same day shipment. These Watlow solid state products include agency approvals including: UL®, VEV, CSA and the CE mark.



Products:

- DIN-A-MITE® solid state power controllers
- SERIES CZ28 compact solid state contactor



DIN-A-MITEs

Data Logging and Trending Software

Watlow provides the latest easy-to-use software for logging and graphing data, creating user interfaces and operating Watlow controllers and other devices.

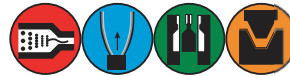

Products:

- SPECVIEW HMI software
- WATVIEW HMI software

Sensor Solutions

Temperature Sensors

Manufactured to recognized agency standards, Watlow thermocouple temperature sensors deliver reliable, accurate temperature measurement. Watlow offers Type J thermocouple sensor assemblies in-stock. These sensors meet the most popular demands of the plastics industry. Made-to-order and non-stock ANSI Type E, K and T thermocouples are also available.



Temperature sensors

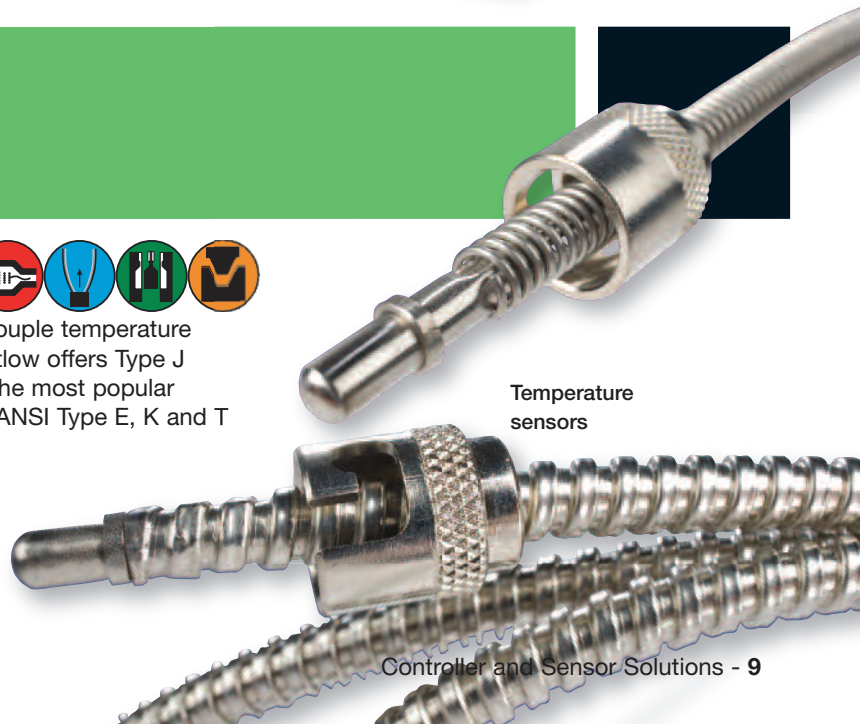

DIN-A-MITE®, E-SAFE®, EZ-ZONE®, FIREROD®, K-RING®, RAYMAX® and Watlow® are registered trademarks of the Watlow Electric Manufacturing Company.

Incoloy® is a registered trademark of Special Metals Corporation.

UL® is a registered trademarks of Underwriter's Laboratories, Inc.



Find out more about Watlow and how we can provide thermal solutions for your company:

Phone: 1 . 800 . WATLOW2

E-mail: info@watlow.com

Web site: www.watlow.com

Watlow Products and Technical Support Delivered Worldwide

North American Technical Support & Sales Offices

North America 1-800-WATLOW2

Asian Technical Support & Sales Offices

Australia +61-3-9335-6449
China +86-21-3381-0188
Japan +81-3-3518-6630
Korea +82-2-2628-5770
Malaysia +60-3-8076-8745
Singapore +65-6773-9488
Taiwan +886-7-288-5168

European Technical Support & Sales Offices

France +33 141 32 79 70
Germany +49 (0) 7253-9400-0
Italy +39 (0) 2 458-8841
United Kingdom +44 (0) 115-964-0777
Spain +34 91 675 1292

Latin American Technical Support & Sales Office

Mexico +52-442-217-6235

About Watlow

Watlow designs and manufactures industrial heaters, temperature sensors, controllers and system assemblies – all of the components of a thermal system. Designing and manufacturing the complete thermal system allows Watlow to recommend, develop and deliver the optimum thermal solution for our customers' equipment and process heat requirements.

Watlow manufactures thermal systems for a broad range of industries including but not limited to: semiconductor processing, photovoltaic, aerospace, analytical instrumentation, medical equipment, packaging, foodservice equipment and plastics processing. Watlow customers receive the highest level of technical engineering combined with exceptional customer service.

Since 1922, Watlow has grown in product capability, market experience and global reach. We hold more than 140 patents and employs 2,000 employees working in 13 manufacturing facilities in the United States, Mexico, Europe and Asia. We also have sales offices in 15 countries around the world. Our company has grown at an exponential rate but our commitment remains the same – to provide our customers with superior products and services for their individual needs.

Your Authorized Watlow Distributor is: