

# EZ-ZONE® RM Limit Module

## User's Guide

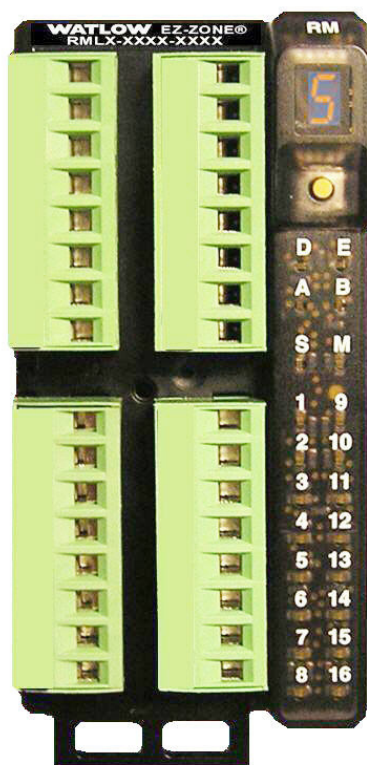

## RM Limit Module



**WATLOW**®  
*Powered by Possibility*



**ISO 9001**



Registered Company  
Winona, Minnesota USA

1241 Bundy Boulevard., Winona, Minnesota USA 55987  
Phone: +1 (507) 454-5300, Fax: +1 (507) 452-4507  
<http://www.watlow.com>

0600-0075-0000 Rev. D



Made in the U.S.A.











March 2016

## Safety Information

We use note, caution and warning symbols throughout this book to draw your attention to important operational and safety information.

- A “NOTE” marks a short message to alert you to an important detail.
- A “CAUTION” safety alert appears with information that is important for protecting your equipment and performance. Be especially careful to read and follow all cautions that apply to your application.
- A “WARNING” safety alert appears with information that is important for protecting you, others and equipment from damage. Pay very close attention to all warnings that apply to your application.
- The safety alert symbol,  (an exclamation point in a triangle) precedes a general CAUTION or WARNING statement.
- The electrical hazard symbol,  (a lightning bolt in a triangle) precedes an electric shock hazard CAUTION or WARNING safety statement. Further explanations follow:

Symbol	Explanation
	CAUTION - Warning or Hazard that needs further explanation than label on unit can provide. Consult User's Guide for further information.
	ESD Sensitive product, use proper grounding and handling techniques when installing or servicing product.
	Unit protected by double/reinforced insulation for shock hazard prevention.
	Do not throw in trash, use proper recycling techniques or consult manufacturer for proper disposal.
	Enclosure made of Polycarbonate material. Use proper recycling techniques or consult manufacturer for proper disposal.
	Unit can be powered with either alternating current (ac) voltage or direct current (dc) voltage.
	Unit is a Listed device per Underwriters Laboratories®. It has been evaluated to United States and Canadian requirements for Process Control Equipment. UL 61010 and CSA C22.2 No. 61010. File E185611 QUXX, QUXX7. See: <a href="http://www.ul.com">www.ul.com</a>
	Unit has been reviewed and approved by Factory Mutual as a Temperature Limit Device per FM Class 3545 standard. See: <a href="http://www.fmglobal.com">www.fmglobal.com</a>
	Unit is compliant with European Union directives. See Declaration of Conformity for further details on Directives and Standards used for Compliance.



Unit has been reviewed and approved by CSA International for use as Temperature Indicating-Regulating Equipment per CSA C22.2 No. 24. See: [www.csa-international.org](http://www.csa-international.org)

## Warranty

The EZ-ZONE® RM Limit module is manufactured by ISO 9001-registered processes and is backed by a three-year warranty to the first purchaser for use, providing that the units have not been misapplied. Since Watlow has no control over their use, and sometimes misuse, we cannot guarantee against failure. Watlows' obligations hereunder, at Watlows' option, are limited to replacement, repair or refund of purchase price, and parts which upon examination prove to be defective within the warranty period specified. This warranty does not apply to damage resulting from transportation, alteration, misuse or abuse. The purchaser must use Watlow parts to maintain all listed ratings.

## Technical Assistance

If you encounter a problem with your Watlow controller, review your configuration information to verify that your selections are consistent with your application: inputs, outputs, alarms, limits, etc. If the problem persists, you can get technical assistance from your local Watlow representative (see back cover), by e-mailing your questions to [wintechsupport@watlow.com](mailto:wintechsupport@watlow.com) or by dialing +1 (507) 494-5656 between 7 a.m. and 5 p.m., Central Standard Time (CST). Ask for for an Applications Engineer. Please have the following information available when calling:

- Complete model number
- All configuration information
- User's Guide
- Factory Page

## Return Material Authorization (RMA)

1. Call Watlow Customer Service, (507) 454-5300, for a Return Material Authorization (RMA) number before returning any item for repair. If you do not know why the product failed, contact an Application Engineer or Product Manager. All RMA's require:
  - Ship-to address
  - Bill-to address
  - Contact name
  - Phone number
  - Method of return shipment
  - Your P.O. number
  - Detailed description of the problem
  - Any special instructions
  - Name and phone number of person returning the product.
2. Prior approval and an Return Merchandise Authorization number from the Customer Service Department is required when returning any product for credit, repair or evaluation. Make sure the Return Merchandise Authorization number is on the outside of the carton and on all paperwork returned. Ship on a Freight Prepaid basis.

3. After we receive your return, we will examine it and try to verify the reason for returning it.
4. In cases of manufacturing defect, we will enter a repair order, replacement order or issue credit for material returned. In cases of customer misuse, we will provide repair costs and request a purchase order to proceed with the repair work.
5. To return products that are not defective, goods must be in new condition, in the original boxes and they must be returned within 120 days of receipt. A 20 percent restocking charge is applied for all returned stock controls and accessories.
6. If the unit cannot be repaired, you will receive a letter of explanation and be given the option to have the unit returned to you at your expense or to have us scrap the unit.
7. Watlow reserves the right to charge for no trouble found (NTF) returns.

This EZ-ZONE® RM Limit User's Guide is copyrighted by Watlow Electric, Inc., © March 2016 with all rights reserved.

EZ-ZONE RM is covered by U.S. Patent No. 6,005,577 and Patents Pending



# Table of Contents

- Table of Contents . . . . . 1**
- Chapter 1: Overview . . . . . 4**
  - Available EZ-ZONE RM System Literature and Resources . . . . . 4
  - A Conceptual View of the RML Module . . . . . 7
    - Inputs . . . . . 7
    - Functions . . . . . 7
    - Outputs . . . . . 8
    - Input Events and Output Events . . . . . 8
    - Actions . . . . . 8
    - Module Limit. . . . . 8
  - Module Orientation . . . . . 11
- Chapter 2: Install and Wire. . . . . 16**
  - Dimensions . . . . . 16
  - Power Supplies . . . . . 17
  - DIN Rail Installation and Removal . . . . . 20
  - Wiring . . . . . 23
  - Conventions Used in the Menu Pages . . . . . 40
- Chapter 3: Operations Pages . . . . . 43**
  - Analog Input Menu . . . . . 45
  - Digital Input/Output Menu . . . . . 46
  - Action Menu. . . . . 46
  - Limit Menu. . . . . 47
  - Alarm Menu . . . . . 48
  - Linearization Menu. . . . . 49
  - Compare Menu . . . . . 50
  - Timer Menu . . . . . 51
  - Counter Menu . . . . . 52
  - Logic Menu . . . . . 52
  - Math Menu. . . . . 54
- Chapter 4: Setup Pages . . . . . 56**
  - Analog Input Menu . . . . . 59
  - Digital Input/Output Menu . . . . . 63
  - Action Menu. . . . . 65
  - Limit Menu. . . . . 66
  - Output Menu . . . . . 69
  - Alarm Menu . . . . . 71
  - Linearization Menu. . . . . 74
  - Compare Menu . . . . . 78
  - Timer Menu . . . . . 81



# Table of Contents (cont.)

Counter Menu .....	83
Logic Menu .....	86
Math Menu.....	94
Variable Menu .....	99
Global Menu.....	100
Communications Menu .....	102
<b>Chapter 5: Factory Pages .....</b>	<b>104</b>
Limit Module Factory Page Parameters.....	104
Custom Setup Menu .....	105
Security Setting Menu .....	105
Diagnostics Menu .....	108
Calibration Menu .....	109
<b>Chapter 6: Features .....</b>	<b>110</b>
Saving and Restoring User Settings .....	111
Module Limit .....	111
Inputs.....	112
10 Point Linearization.....	115
Alarms .....	116
Process Alarms.....	116
Alarm Set Points.....	116
Alarm Hysteresis.....	116
Alarm Latching .....	116
Alarm Silencing.....	117
Alarm Blocking .....	117
Using Password Security.....	118
Modbus - Using Programmable Memory Blocks.....	119
Software Configuration .....	120
Using EZ-ZONE Configurator Software.....	120
Function Block Descriptions .....	125
Action Function.....	125
Alarm Function .....	126
Analog Input Function.....	128
Compare Function.....	130
Counter Function .....	132
Custom Function.....	133
Diagnostic Function .....	133
Digital Input/Output Function .....	134
Global Function.....	135
Linearization Function.....	136



# Table of Contents (cont.)

Logic Function .....	138
Math Function .....	142
Modbus® Function .....	147
Output Function .....	148
Security Function .....	149
Timer Function .....	150
Variable Function .....	156
<b>Chapter 8: Appendix .....</b>	<b>157</b>
Modbus® - Programmable Memory Blocks .....	157
Troubleshooting Alarms, Errors and Module Issues .....	161
RML Specifications .....	165
RML Ordering Information .....	171
How to Reach Us .....	173

# 1

## Chapter 1: Overview

### Available EZ-ZONE RM System Literature and Resources

Document Title and Part Number	Description
EZ-ZONE Rail Mount Access (RMA) User's Guide, part number: 0600-0072-0000	Describes how to connect the RM system into an industrial network, how to use data logging, module backup and the real-time clock.
EZ-ZONE Rail Mount Controller (RMC) User's Guide, part number: 0600-0070-0000	The RMC module is an advanced integrated controller capable of PID and limit control. This document describes how to configure and program all loops of control and communications.
EZ-ZONE Rail Mount High Density (RMH) User's Guide, part number: 0600-0074-0000	This module extends the density of the standard RM modules (number of control loops and I/O points). The User Guide describes common usage, communications and the number I/O points available.
EZ-ZONE Rail Mount Scanner (RMS) User's Guide, part number: 0600-0071-0000	This module adds monitoring points to the RM system. This document describes common usage and the various types of I/O available.
EZ-ZONE Rail Mount Expansion (RME) User's Guide, part number: 0600-0073-0000	When additional I/O is needed the Expansion module fills the gap. This document describes common usage and the various types of I/O available.
EZ-ZONE Remote User Interface (RUI) User's Guide, part number: 0600-0060-0000	The RUI provides a visual LED display to the RM configuration and setup menus. This document illustrates and describes connections and also describes the Home Page for each RM module as viewed from the RUI.
EZ-ZONE RM Specification Sheet, part number: WIN-EZRM-0414	Describes RM hardware options, features, benefits and technical specifications.
Watlow Support Tools DVD, part number: 0601-0001-0000	Contains all related user documents, tutorial videos, application notes, utility tools, etc...

The DVD described above ships with the product and as stated contains all of the literature above as well as much more. If the DVD is not available one can be acquired by contacting Watlow Customer Service at 1-507-454-5300.

As an alternative to the DVD, all of the user documentation described above can also be found on the Watlow website. Click on the following link to find your document of choice: <http://www.watlow.com/literature/manuals.cfm>. Once there, simply type in the desired part number (or name) into the search box and download free copies.



## Your Comments are Appreciated

In an effort to continually improve our technical literature and ensure that we are providing information that is useful to you, we would very much appreciate your comments and suggestions. Please send any comments you may have to the following e-mail address: [TechlitComments@watlow.com](mailto:TechlitComments@watlow.com)

---

### Introduction

The EZ-ZONE® Rail Mount Limit Module (RML) is used in thermal applications to limit inadvertent over-temperature conditions. The RML controller provides multi-loop (12 loops maximum) safety assurance against instances where over or under temperature runaway conditions could occur from a shorted input sensor or an output device that could fail in a closed position. The RML is recommended for any application where thermal runaway could result in large product scrap costs, affect operator safety, cause damage to equipment, or create a fire hazard.

It just got a whole lot easier to solve the thermal requirements of your system. The EZ-ZONE RML module is provided in a space-saving, rail-mount package and is highly scalable where you only pay for what you need. Ordering options allow for 1 to 12 loops and for those applications that require the ability to configure/monitor over a network the Modbus RTU communication protocol is an option. Other communications protocols are also available (e.g., Ethernet/IP, DeviceNet, Modbus TCP and Profibus DP) when used in conjunction with a Rail Mount Access (RMA) module or when using a Remote User Interface/ Gateway (RUI/GTW).

---

### Standard Features and Benefits

#### Communication Capabilities

- Supports network connectivity to a PC or PLC
- Watlow Standard Bus or Modbus® RTU
- Provides plug and play capabilities with Remote User Interface (RUI's) and RMA module
- Free standard bus communications port and free PC software (EZ-ZONE Configurator and Composer)

#### FM Approved Over-under Limit with Auxiliary Outputs

- Increases user and equipment safety for over-under temperature conditions

#### Parameter Save & Restore Memory

- Reduces service calls and down time

#### Agency approvals: UL Listed, CSA, CE, RoHS, W.E.E.E. FM

- Assures prompt product acceptance
- Reduces end product documentation costs
- FM approval on Limit Models
- Semi F47-0200

#### Three-year warranty

- Demonstrates Watlow's reliability and product support

#### Touch-safe Package

- IP2X increased safety for installers and operators

**Removable cage clamp wiring connectors**

- Reliable wiring, reduced service calls
- Simplified installation

**Programmable Menu System**

- Reduces set up time and increases operator efficiency

**Full-featured Alarms**

- Improves operator recognition of system faults
- Control of auxiliary devices

## A Conceptual View of the RML Module

The flexibility of the RML's software and hardware allows for variation in configurations. Acquiring a better understanding of its functionality and capabilities while at the same time planning out how the controller can be used will deliver maximum effectiveness in your application.

It is useful to think of the controller in three parts: inputs, procedures and outputs. Information flows from an input to a procedure to an output when the controller is properly configured. An RML controller can carry out several procedures at the same time, e.g., monitoring for several different alarm situations, monitoring and acting upon digital inputs and driving output devices such as audible alarms, lights and contactors. Each process needs to be thought out carefully and the controller's inputs, procedures and outputs set up properly.

---

### Inputs

The inputs provide the information that any given programmed procedure can act upon. Simply stated, this information may come from an operator pushing a button or from a sensor monitoring the temperature of a part being heated or cooled.

Each analog input typically uses a thermocouple, RTD or thermistor to read the process temperature. It can also read volts, current or resistance, allowing it to use various devices to read humidity, air pressure, operator inputs and others values. The settings in the Analog Input Menu (Setup Page) for each analog input must be configured to match the device connected to that input.

Each digital input reads whether a device is active or inactive. An RML equipped with digital input/output hardware includes two sets of terminals where each of which can be used as either an input or an output. Each pair of terminals must be configured to function as either an input or output with the direction parameter in the Digital Input/Output Menu (Setup Page).

---

### Functions

Functions use input signals to calculate a value. A function may be as simple as reading a digital input to set a state to true or false, or reading a temperature to set an alarm state to on or off. Alternatively, if a failure with the primary sensing device should occur the limit could trip a contactor removing power from the heating element to avoid damaging the load.

To set up a function, it's important to tell it what source, or instance, to use. For example, if the control is equipped with digital inputs they can be configured to reset an individual alarm or all alarms. If configured as such, the next step would be to define which of the available digital inputs would be tied to the alarm reset function. The RML module can be equipped with up to 7 digital inputs, instance 1 - 6 and or 9. Once the specific input has been selected simply assign the alarm reset function to it (Setup Page, DIO Menu). The last step would be to define the alarm instance that should be reset. If zero is entered for the alarm instance when the digital input selected above is enabled, all latched alarms without a currently existing alarm condition will be reset. If a specific alarm instance (1 -16) is selected it will be that instance alone that will be reset.

#### Note:

Alarms will reset automatically when the condition that caused the alarm goes back to a non-alarm state if the alarm latching prompt is set to non-latching (Setup Page, ALM Menu).

Keep in mind that a function is a user-programmed internal process that does not execute any action outside of the controller. To have any effect outside of the controller, an output must be configured to respond to a function.

## Outputs

Outputs can perform various functions or actions in response to information provided by a function, such as removal of the control voltage to a contactor; turning a light on or off; unlocking a door; or turning on an audible alarm.

Assign an output to a function in the Output Menu or Digital Input/Output Menu. Then select which instance of that function will drive the selected output. For example, in using a Limit Control an output can be configured to respond to an alarm, i.g., (instance 15) or to a limit condition.

You can assign more than one output to respond to a single instance of a function. For example, alarm 2 could be used to trigger a light connected to output 1 and a siren connected to digital output 5.

---

## Input Events and Output Events

Input events are internal states that are set by the digital inputs. Digital Input 1 provides the state of input event 1, and Digital Input 2 provides the state of input event 2. The setting of Digital Input Function (Setup Page, Digital Input/Output Menu) does not change the relationship between the input and the event. An input will still control the input event state, even if Digital Input Function is set to None.

---

## Actions

Based on a given input (Digital I/O, Event output, Logic function, etc..) the Action function can cause other functions to occur. To name a few, set alarms to off, silencing alarms and reset a tripped limit condition.

---

## Module Limit

This function allows the user to setup a single output to reflect an energized (safe) or deenergized (tripped) state for the module. If any configured limit is tripped (process value exceeds set point or limit input has malfunctioned), the output assigned to serve as this function will come on. By default (factory settings), output 8 is assigned this function where any output of choice can be configured as such.

---

## A Conceptual View of RM Hardware Configurations

Due to the scalability and flexibility in the RM system a user has several options available in the way that the hardware can be connected. Listed below are a few examples.

## RML Connected to a Remote User Interface (RUI) and a Personal Computer (PC)

In this configuration the RUI and PC are connected to the RML module via Watlow's Standard Bus where both will be able to talk directly to the RML module.

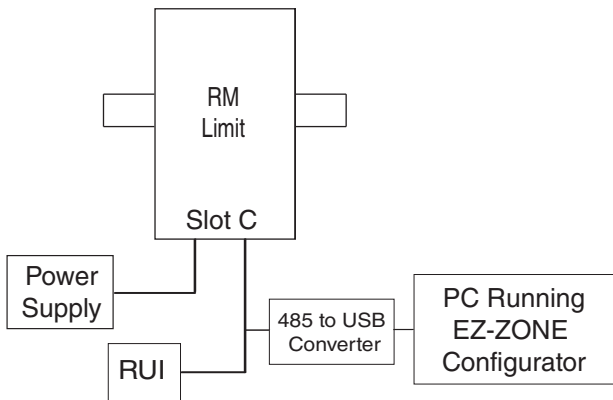

In the graphic above the PC running EZ-ZONE Configurator software and or the RUI can be used to configure and then monitor the RML and other modules connected to it.

---

## RML Module Connected to a Programmable Logic Controller (PLC) on a DIN Rail

In this configuration the PLC can be connected to the RML module using the Modbus RTU protocol:

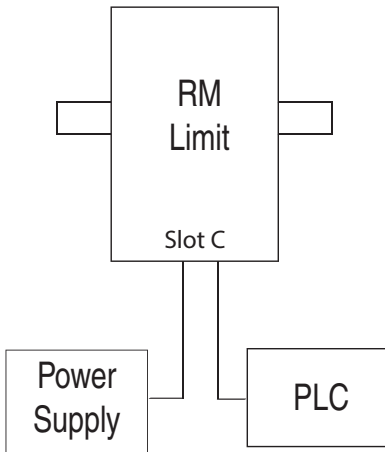

In this example, the RML module and the PLC must be equipped with the Modbus RTU protocol.

### Note:

If it is intended to use an RUI or a PC using EZ-ZONE Configurator software it will be necessary to switch the protocol on the RML to Watlow's Standard Bus to successfully communicate; disconnect all Modbus devices from the network. Once done using the RUI or EZ-ZONE Configurator software, switch the protocol back to Modbus RTU and reconnect all Modbus devices to re-establish communications over Modbus.

## RML Module Connected to an Operator Interface Terminal (OIT) through an RMA

In this configuration the RML can be connected to the OIT through the RMA running any of a number of available protocols. The RMA and the OIT must be using the same protocol while the communications from RMA to the RML module is accomplished over the backplane using Watlow's Standard Bus protocol. Available protocols in the RMA follow:

1. EtherNet/IP and or Modbus TCP
2. DeviceNet
3. Modbus RTU
4. Profibus DP

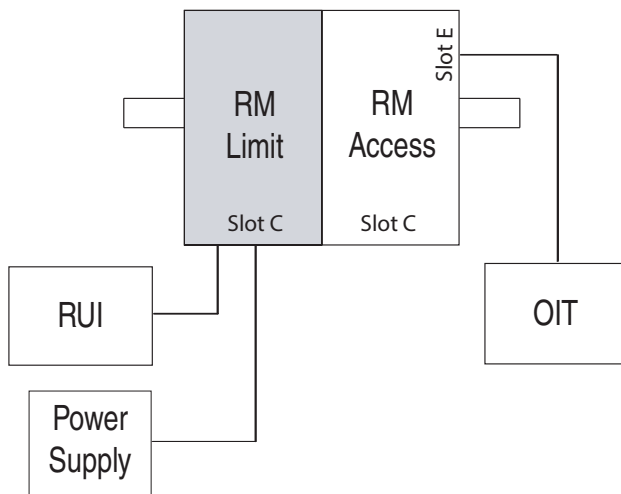

Notice that in the example above that there is an optional RUI connected to the RML along with the OIT. OIT's are not generally used to configure a control but are used more for run-time information. As an alternative for configuration the RUI could be used to configure and monitor in a remote location.

One advantage in using an RMA module when communicating on a network is that protocol switching is not needed on the RML module if using an RUI or EZ-ZONE Configurator or Composer software. The protocol of choice used with the RMA can run simultaneously with the Standard Bus protocol.

---

## RML Connected to a Split Rail with OIT

In this configuration both the inter-module bus (backplane communications) and Standard Bus are connected between rails to allow for remote capabilities. It is recommended that the split rail connection not exceed 100 feet. In this configuration the OIT can communicate with all modules (maximum 16 modules any combination with one Access module).

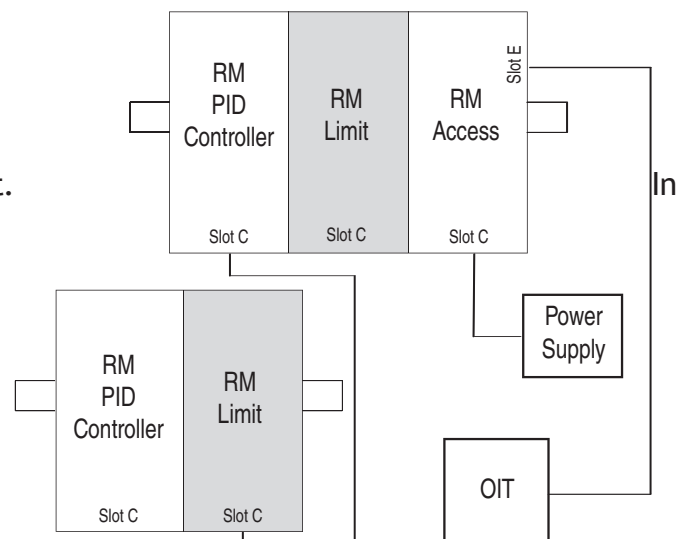

## Module Orientation

The picture that follows represents one of several different RM modules. All of them will have four slots on the face (slot A, B, D, and E) and one on the bottom (slot C) not shown. All of these slots are not always used on all modules. On the face of the module there is a button (yellow circle) under the Zone address (5). When pushed and held it has the following functions:

1. For any module, push and hold for ~ 2 seconds to change the Zone address
2. When a module is equipped with the Modbus protocol (RMxxxxxxxx1xx) pushing and holding this button for ~ 6 seconds the LED display will return **P** for protocol. Releasing the button and then pushing it again (within 6 seconds) the display will toggle between **M** (Modbus) and **S** (Standard Bus). Valid addresses for Modbus and Standard bus range from 1 -16 (**i** - **q**, **A** is 10, **b** is 11, **C** is 12, **d** is 13, **E** is 14, **F** is 15, and **h** is 16). The RMA (Access) module is shipped at address **J** or 17 and is the only module that can have its address set above 16.

### Note:

For correct operation and accuracy, the module must be mounted in a vertical orientation as shown.

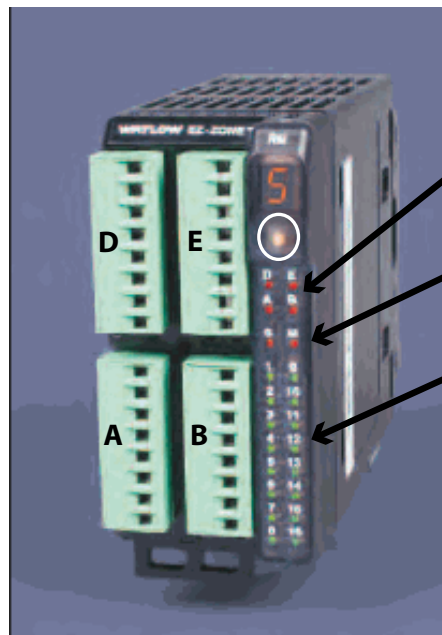

**Module Status**  
(Slot A, B, D, or E)

**Protocol**  
Standard Bus - red  
Modbus - green

**Module Outputs**  
1 through 16, all may or may not be used depending on module type

---

## Getting Started Quickly

Consider taking the following steps to quickly commission your control:

- Wire and connect the power source to the control
- Wire and connect input and output devices to the control
- Power up the control and navigate to the Setup Page to configure inputs, outputs, alarms, etc...
- Once the control is setup, navigate to the Operations Page to set limit and alarm set points.

The default RML loop configuration out of the box is shown below:

- Analog Input functions are set to thermocouple, type J (to change go to the Setup Page)
- Limit sides set to both, high and low (to change go to the Setup Page)
- Output 8 set to module limit (to change go to the Setup Page)
- Limit low set point set to 0°F (to change go to the Operations Page)
- Limit high set point set to 0°F (to change go to the Operations Page)
- Limit is deenergized, also referred to as a tripped state

Once the control has been wired and setup, power up the control and change the appropriate limit set points (high and or low) to the desired value (on the RUI push the up ▲ and or down ▼ arrow key). Once the set point is set to the desired level, reset the limit by using one of the four methods described below:

1. Use a digital input, function key or a variable to reset the limit
2. Using an RUI, push the green Advance Key ⏩ and then the Infinity Key ∞
3. If RML is equipped with Modbus RTU, send the enumerated value of zero (0) to register 1490, loop 1 (see the Operations Page, Limit Menu)
4. Cycle power on the control

#### EZ-ZONE RML Default Configuration

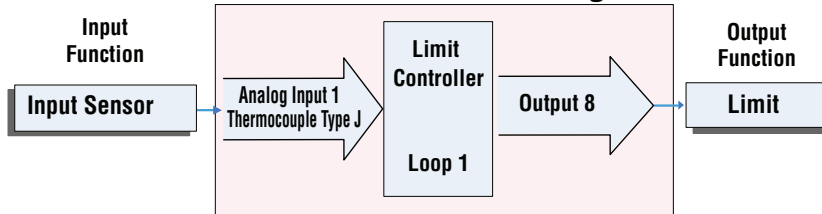

#### Note:

Output 8 will default as a module limit. As a module limit, the LED will be illuminated when one or more limit loops is in a tripped (de-energized) state. When the module is in a safe state the output LED will be off.

The RML controller has a page and menu structure that is listed below along with a brief description of its purpose. The menu structure can be easily seen and navigated using [EZ-ZONE Configurator software](#) or the Remote User Interface (RUI).

#### Note:

The menu navigation as described below applies when the RML is connected to the RUI which is optional equipment.



<p><b>Setup Page</b> Using the RUI, push and hold the up and down keys (▲ ▼) for 6 seconds to enter. (See the <a href="#">Setup Page</a> for further information)</p>	<p>A user would want to setup their control prior to operation. As an example, define the limit sides (high and or low), change the input type, or set the output function.</p>
<p><b>Operations Page</b> Using the RUI push and hold the up and down keys (▲ ▼) for 3 seconds to enter. (See the <a href="#">Operations Page</a> for further information)</p>	<p>After setting up the control to reflect your equipment, the Operations Page would be used to monitor or change runtime settings. As an example, the user may want to change the limit high/low set point or perhaps change an alarm set point.</p>
<p><b>Factory Page</b> Using the RUI push and hold the Infinity and the green Advance keys (∞ Ⓞ) for 6 seconds to enter. (See the <a href="#">Factory Page</a> for further information)</p>	<p>For the most part the Factory Page has no bearing on the control when running. A user may want to enable password protection, view the control part number or perhaps create a custom Home Page.</p>
<p><b>Home Page</b> When using the RUI the control is at the Home Page when initially powered up.</p> <p><b>Note:</b> The Home Page is visible only when using the RUI.</p>	<p>Pushing the green Advance Key Ⓞ and then the Infinity Key ∞ will reset a limit if tripped (if trip condition no longer exists); or, by pushing the green Advance Key Ⓞ the limit high and or low set points could be displayed and changed using the up and down keys (▲ ▼).</p>

**EZ-ZONE RML-Limit Module - System Diagram**  
**12 Limit Loops-Slots A, B, D**  
**4-Form A Mechanical Relay Outputs Slot E**

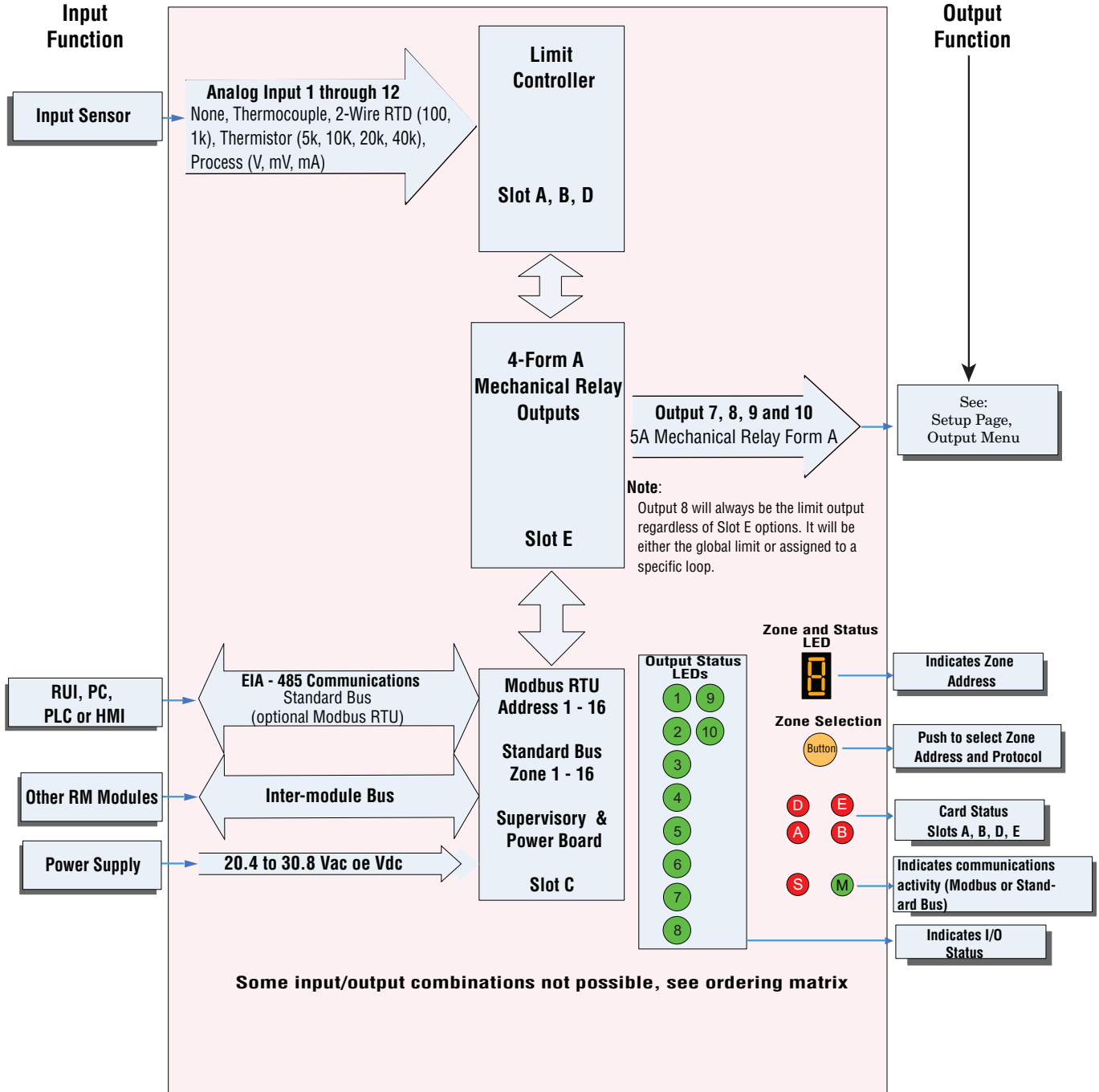

## EZ-ZONE RML-Limit Module - System Diagram 6-Digital Inputs or Output Card in Slot D 1-Digital Input/2 Mechanical Relay Outputs Slot E

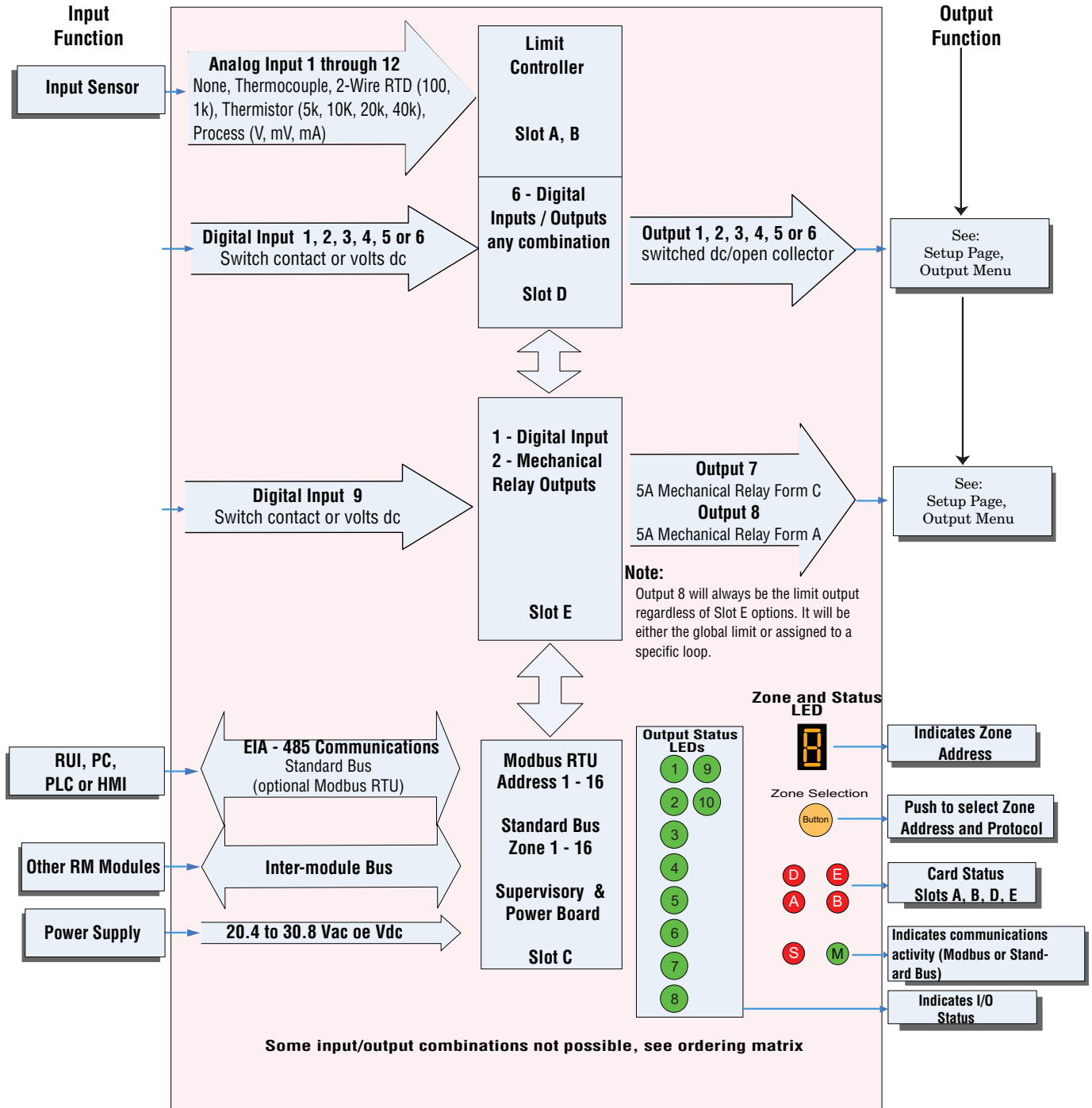

# 2

## Chapter 2: Install and Wire

### Dimensions

As can be seen below the dimensions of the RML module will change slightly based on the type of connector used.

#### Note:

Modules should always be mounted vertically. For easy removal and placement of modules it is recommended that there be a 76.2 mm (3.00 in) clearance on the top, bottom and front of each module.

#### Module Removal Clearance

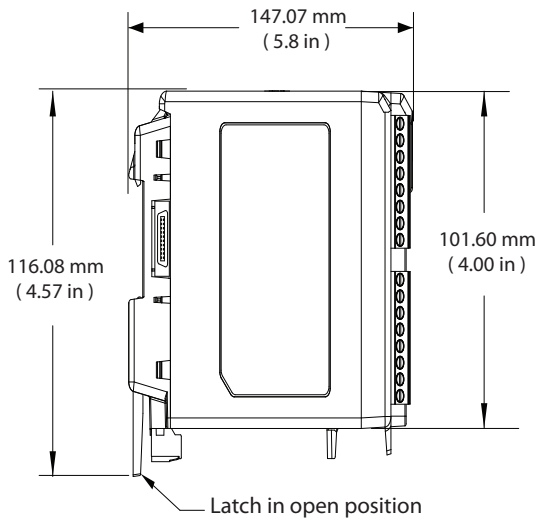

#### Standard Connectors

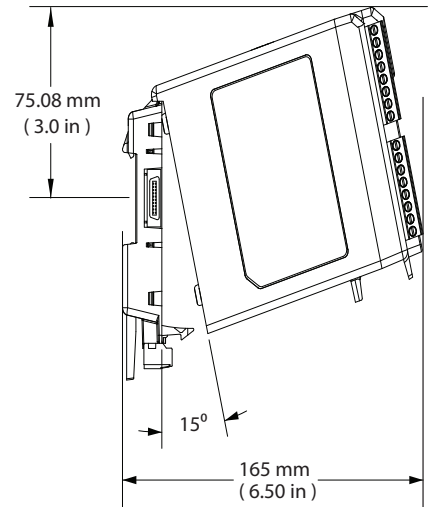
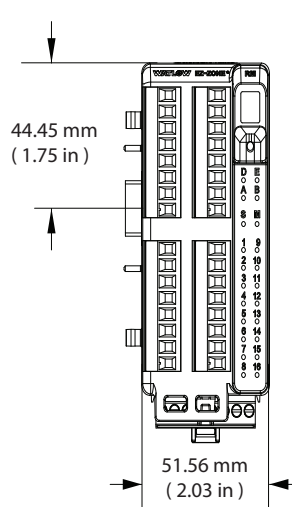

Module Removal Displacement

#### Module Removal Clearance

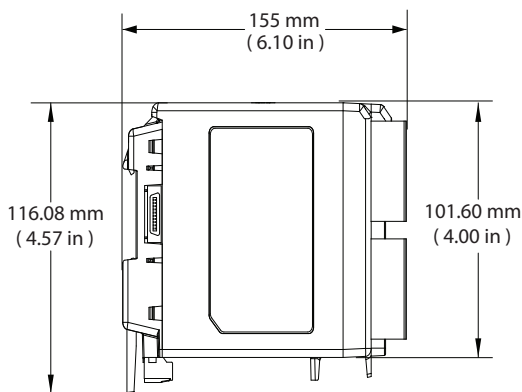

#### Straight Connectors

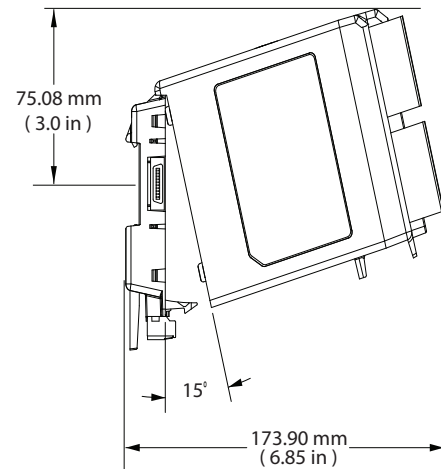
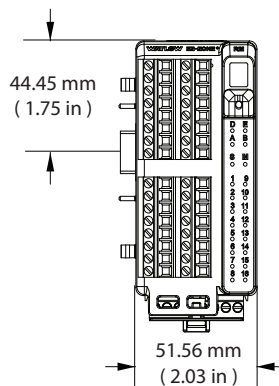

Module Removal Displacement

## Dimensions (cont.)

### Chassis Mount Front View (Module Removed) - Screw Connection Pattern

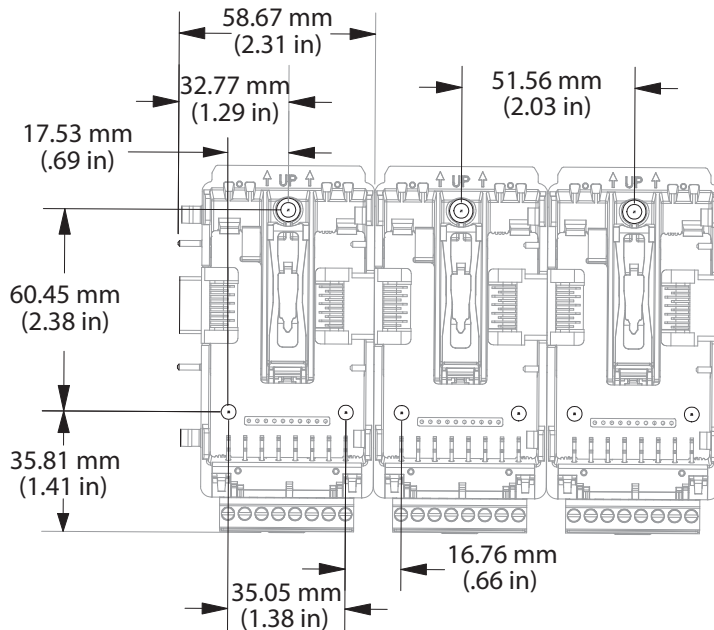

The view above is representative of the modular backplane without the module.

Recommended chassis mount hardware:

1. #8 screw, 3/4" long
2. Torque to 10 -15 in-lb
3. No washers of any kind

## Power Supplies

### DSP 30

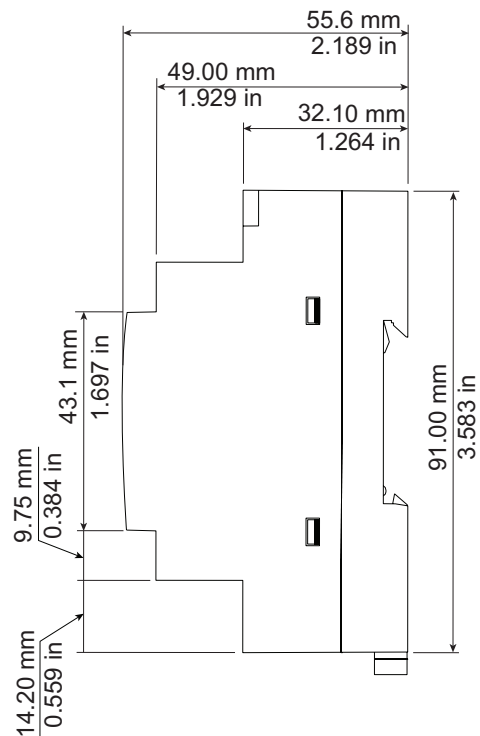
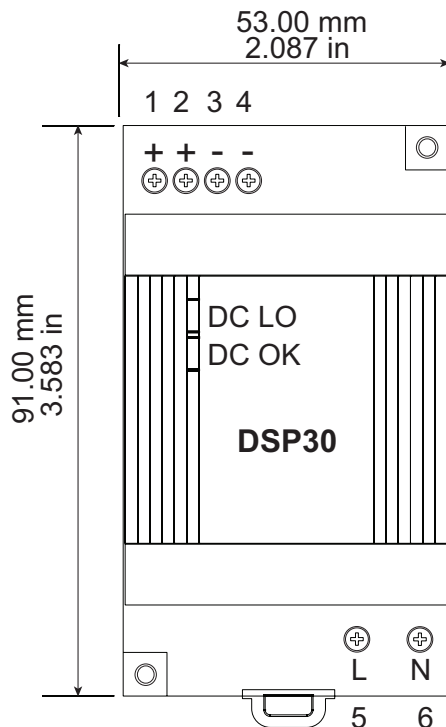

### DSP 60

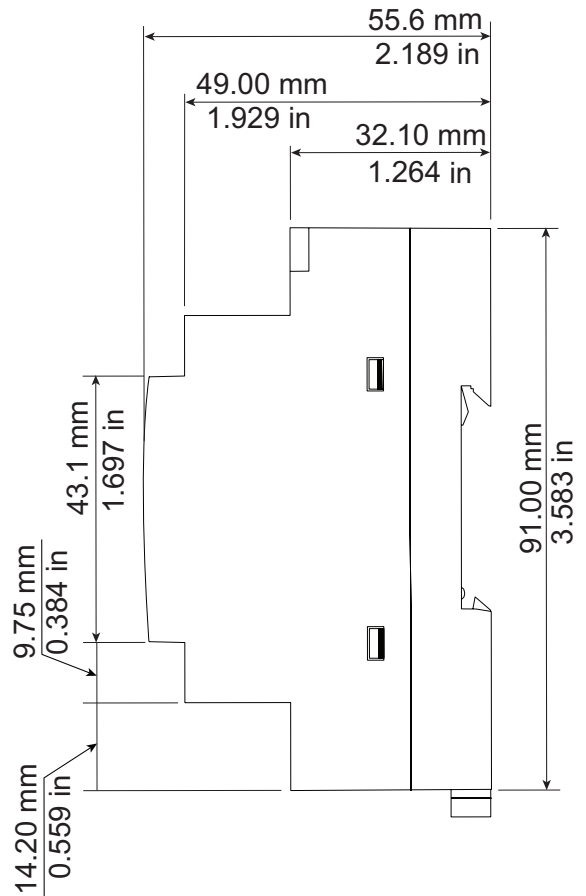
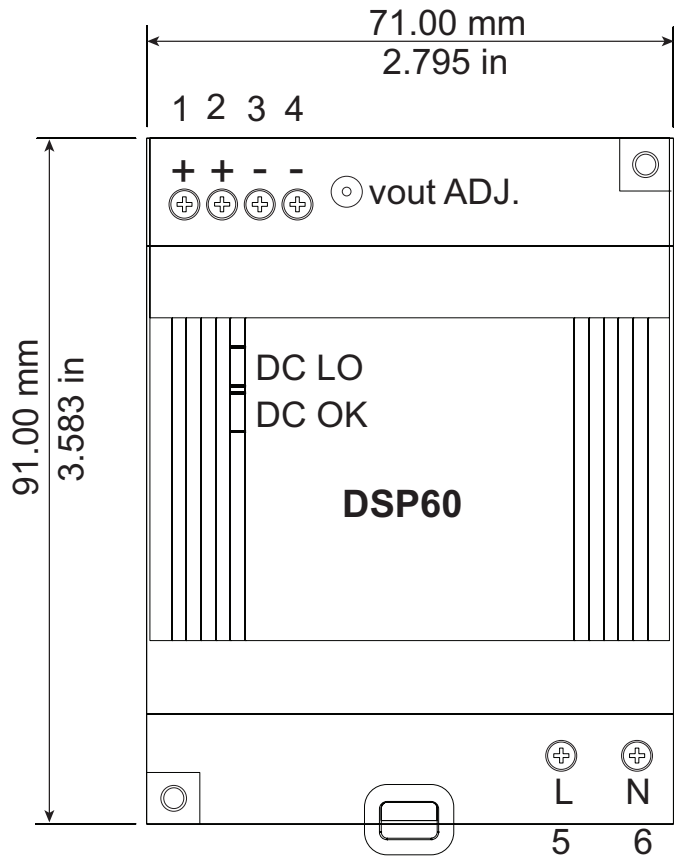

### DSP 100

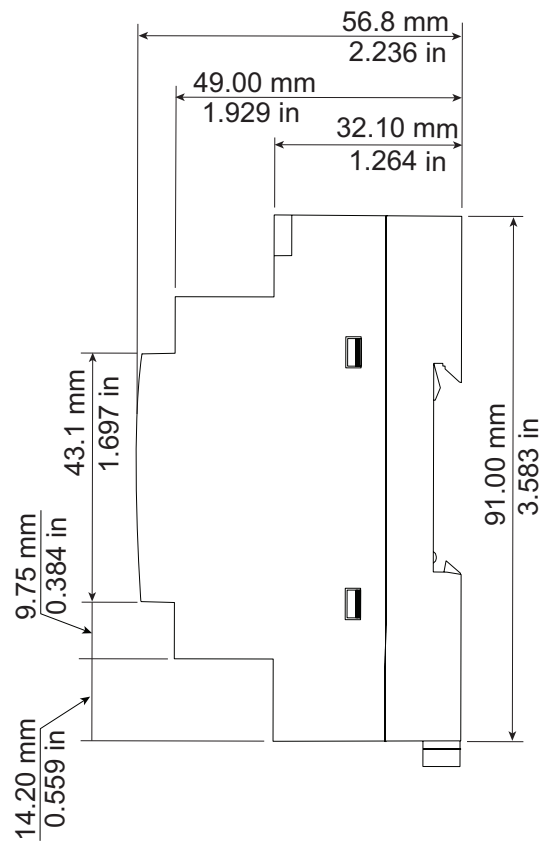
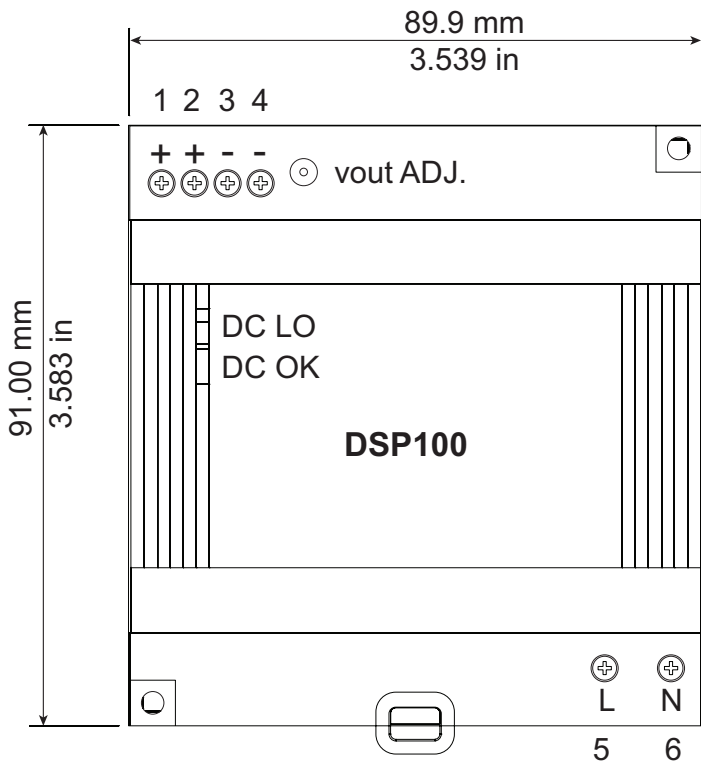

Power Supply Specifications				
		DSP 30	DSP60	DSP100
AC Input Voltage Range	VAC	90 - 264VAC, Class II double insulated (No ground connection required)		
Input Frequency	Hz	47 - 63Hz		
DC Input Voltage range	VDC	120 - 370VDC		
Inrush Current (115 / 230VAC)	A	25 / 50A	30 / 60A	30 / 60A
Output Voltage Accuracy	%	±1% of Nominal		
Over voltage Protection	V	120 - 145%		
LED Indicators	- - - -	Green LED = On, Red LED = DC Output Low		
Operating Temperature	- - - -	-25 to +71°C (Derate linearly 2.5%/°C from 55 to 71°C)		
Storage Temperature	- - - -	-25 to +85°C		
Operating Humidity	- - - -	20 - 95% RH (non condensing)		
Vibration (Operating)	- - - -	IEC 60068-2-6 (Mounting by rail: Random wave, 10-500 Hz, 2G, ea. along X, Y, Z axes 10 min/cycle, 60 min)		
Safety Agency Approvals		UL1310 Class 2(1), UL508 Listed, UL60950-1, EN60950-1, CE		

For a comprehensive listing of these specifications point your browser to : <http://us.tdk-lambda.com/lp/products/dsp-series.htm>

# DIN Rail Installation and Removal

## Modular Backplane Connector

The picture on the right shows the Modular Backplane Connector, both front and rear view. The rear view is bringing in to focus a metal clip. If the DIN rail is grounded the Modular Backplane Connector and the module connected to it will be also (recommended).

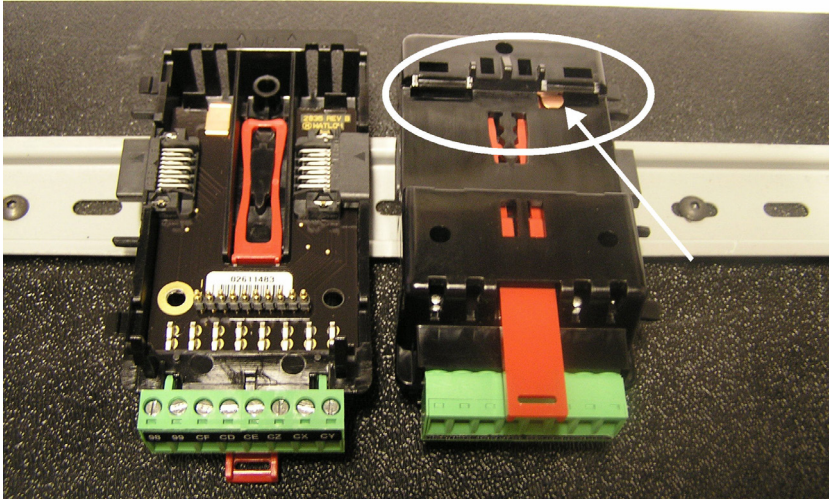

## Installing the Modular Backplane Connector

To install the backplane follow the steps below:

1. Hook backplane assembly to upper edge of DIN rail, (see rear view above, backplane hook detail that mates with upper rail edge is circled)
2. Next, rotate back plane assembly downward to engage the lower edge of the rail. (Note: Din Rail clipping distance ranges from 1.366 -1.389 inches. The back plane assembly will not latch onto the rail successfully if the rail is out of dimension).
3. For final positioning and locking, the red tab is to be pushed upward to further engage the bottom edge of the rail with an over center snap action latch. (The red locking tab protrudes from the bottom side of the back plane assembly).

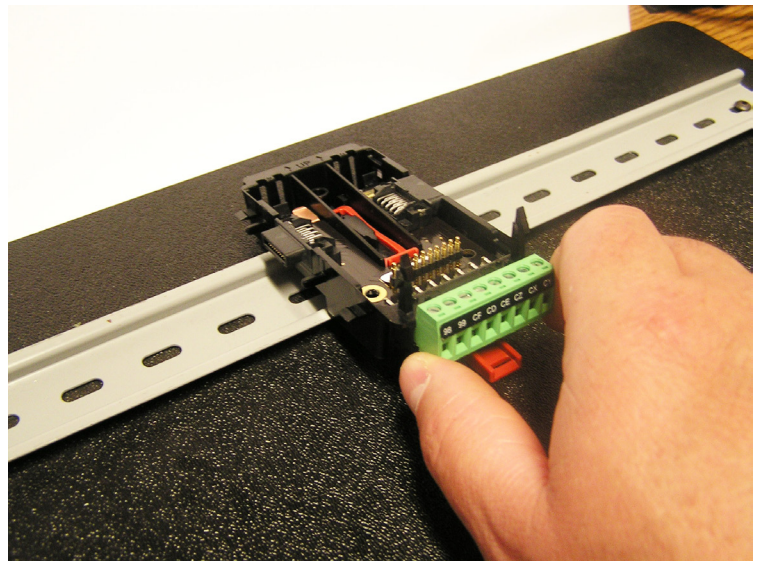

### Note:

For easy removal and placement of modules it is recommended that there be a 76.2 mm (3.00 in) clearance on the top, bottom and front of each module.



## Installing Multiple Modular Backplane Connectors

Multiple modules are easily aligned and latched together. Each module includes matched mating geometry that facilitates accurate and consistent interconnections.

*To install backplane connectors follow the steps below:*

1. Attach individual modules to the rail separately.
2. Laterally slide the modules together until they touch.
3. When the multi-module system is attached and laterally positioned to the desired placement the locking tab should be engaged to secure the control system to the rail.

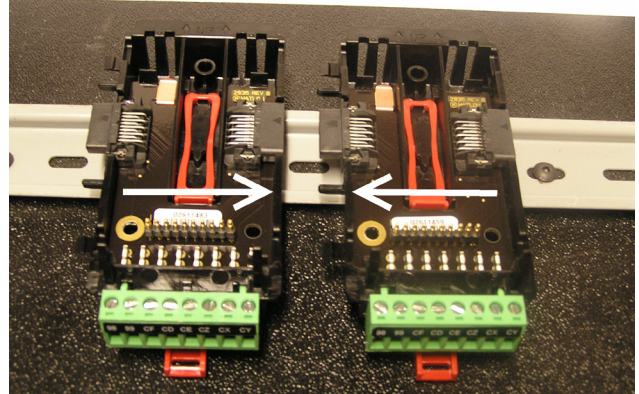

## Module Installation

In the picture to the right notice that the arrow is pointing at the top lip of the module (on side).

*To install modules on the backplane follow the steps below:*

1. Slide the lip of the module over the top of the Modular Backplane Connector and then push down on the rear of the module. The module will then slide over the two posts just above the green connector (see pictures below).

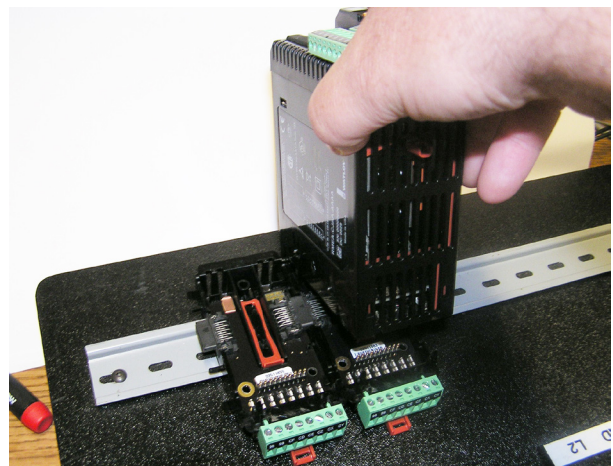
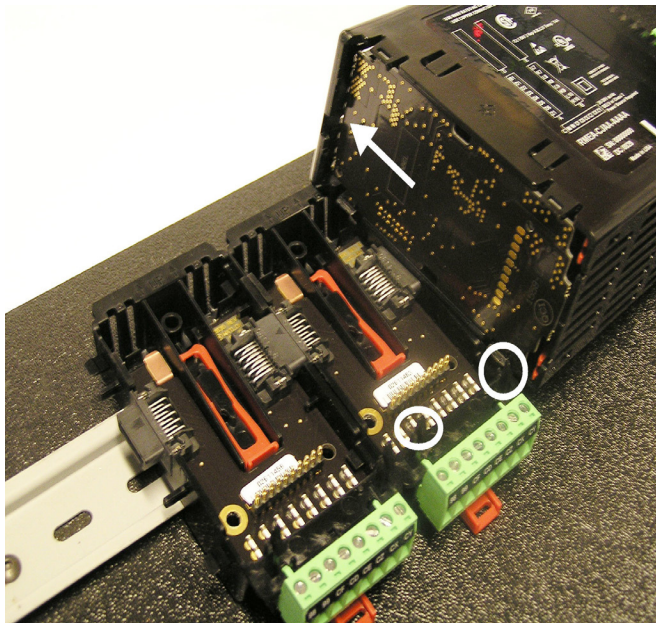

## Module Removal

To remove a module from the backplane follow the steps below:

1. Find the red tab protruding from the bottom of the module and pull back on it as shown to the right.
2. Pull back on the red tab, the two mounting posts will then release the module.
3. Lift the module up and slide it up; this will release the module lip from the backplane.

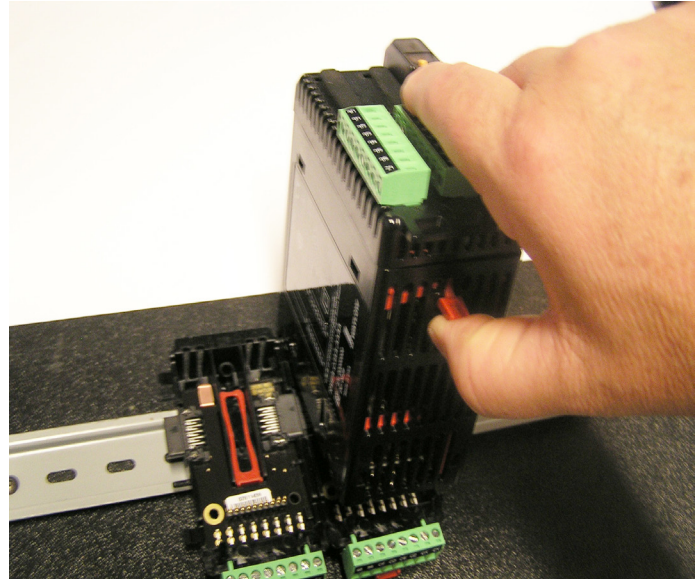

---

## Backplane Removal from DIN Rail

To remove a modular backplane connector from the DIN rail follow the steps below:

1. Insert a screw driver into the red locking tab just behind the green connector.
2. Apply downward pressure on the tab by lifting the screwdriver upwards..
3. When released, the tab will move downward and the connector can then be lifted up off of the DIN rail.

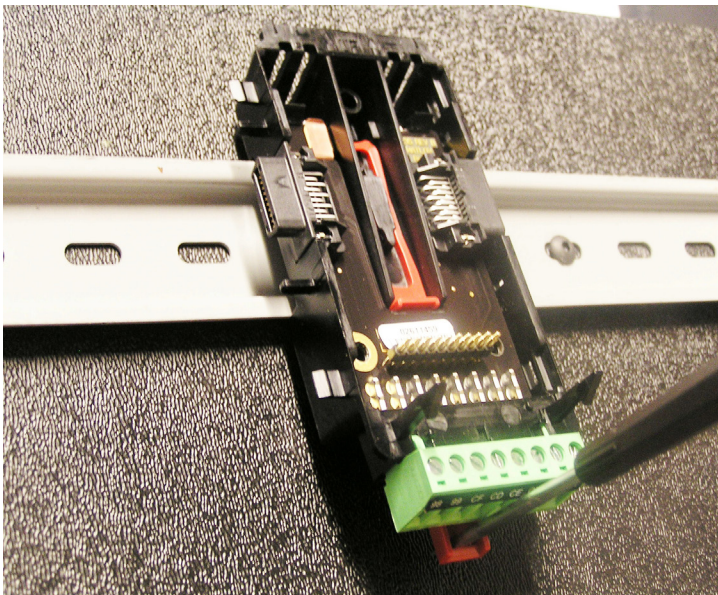

## Wiring

Limit Module (RMLx-xxxx-xxxx)					
Slot A	Slot B	Slot D	Slot E	Terminal Function	Configuration
Inputs				Universal, RTD and Thermistor Inputs 1 -12	
1 - 4	5 - 8	9 - 12	---		
S1 R1 S2 R2 S3 R3 S4 R4	S5 R5 S6 R6 S7 R7 S8 R8	S9 R9 S10 R10 S11 R11 S12 R12	--- --- --- --- --- --- --- ---	S <sub>-</sub> (RTD), thermocouple -, volts -, mA -, potentiometer or thermistor  R <sub>-</sub> (RTD), thermocouple +, volts +, mA +, potentiometer wiper or thermistor	Universal/Thermistor Input Part # Digits 5, 6, 7 Input 1-4: RMLx-(5,6)xxx-xxxx Input 5-8: RMLx-x(5,6)xx-xxxx Input 9-12: RMLx-xx(5,6)x-xxxx
				Digital Inputs 1 - 6	
---	---	1 - 6	---		
---	---	B1 D1 D2 D3 D4 D5 D6 Z1	--- --- --- --- --- --- --- ---	Common DC +input DC +input DC +input DC +input DC +input DC +input Internal Supply	Digital Inputs (DI) Part # Digit 7 Slot A: Option not valid Slot B: Option not valid Slot D: RMLx-xx(C)x-xxxx Slot E: Option not valid
				Digital Input 9	
---	---	---	9		
---	---	---	---		
---	---	---	---		
---	---	---	---		
---	---	---	---		
---	---	---	B9 D9	Common DC +input	Digital Input (DI) Part # Digit 8 Slot A: Option not valid Slot B: Option not valid Slot D: Option not valid Slot E: RMLx-xxx(B)-xxxx
Outputs				Form A - Mechanical Relay Outputs 1- 4 and 7 - 10	
---	---	1 - 4	7 - 10		
---	---	L1 K1 L2 K2 L3 K3 L4 K4	L7 K7 L8 K8 L9 K9 L10 K10	normally open common normally open common normally open common normally open common	Mechanical Relay 5 A, Form A Part # Digits 7, 8 Slot D: : RMLx-xx(J)x-xxxx Slot E: : RMLx-xxx(J)-xxxx

## Wiring (cont.)

Outputs				Form C - Mechanical Relay Output 7 and Form A - Mechanical Relay Output 8	
Slot A	Slot B	Slot D	Slot E	Terminal Function	Configuration
---	----	---	7 - 8		
---	---	---	L7	normally open	Form C and Form A Relay Outputs Part # Digit 8 Slot A: Option not valid Slot B: Option not valid Slot D: Option not valid Slot E: RMLx-xxx(B)-xxxx
---	---	---	K7	common	
---	---	---	J7	normally closed	
---	---	---	L8	normally open	
---	---	---	K8	common	
---	---	---	---		
---	---	---	---		
---	---	---	---		
				<b>Digital Outputs 1 - 6</b>	
---	---	1 - 6	---		
---	---	B1	---	Common	Digital Outputs (DO) Part # Digit 7 Slot A: Option not valid Slot B: Option not valid Slot D: RMLx-xx(C)x-xxxx Slot E: Option not valid
---	---	D1	---	open collector/ switched dc	
---	---	D2	---	open collector/ switched dc	
---	---	D3	---	open collector/ switched dc	
---	---	D4	---	open collector/ switched dc	
---	---	D5	---	open collector/ switched dc	
---	---	D6	---	open collector/ switched dc	
---	---	Z1	---	Internal Supply	

<b>Power and Communications</b>		
Slot C		Configuration
98 99	Power input: ac or dc+ Power input: ac or dc-	All
CF CD CE	Standard Bus EIA-485 common Standard Bus EIA-485 T-/R- Standard Bus EIA-485 T+/R+	Standard Bus Part # Digit 10 RMLx-xxxx-x(A)xx
CC CA CB	Standard Bus or Modbus RTU EIA-485 common Standard Bus or Modbus RTU EIA-485 T-/R- Standard Bus or Modbus RTU EIA-485 T+/R+	Standard Bus or Modbus Part # Digit 10 RMLx-xxxx-x(1)xx
CZ CX CY	Inter-module Bus Inter-module Bus Inter-module Bus	Inter-module Bus

## RML Module - Front View - Standard Connector

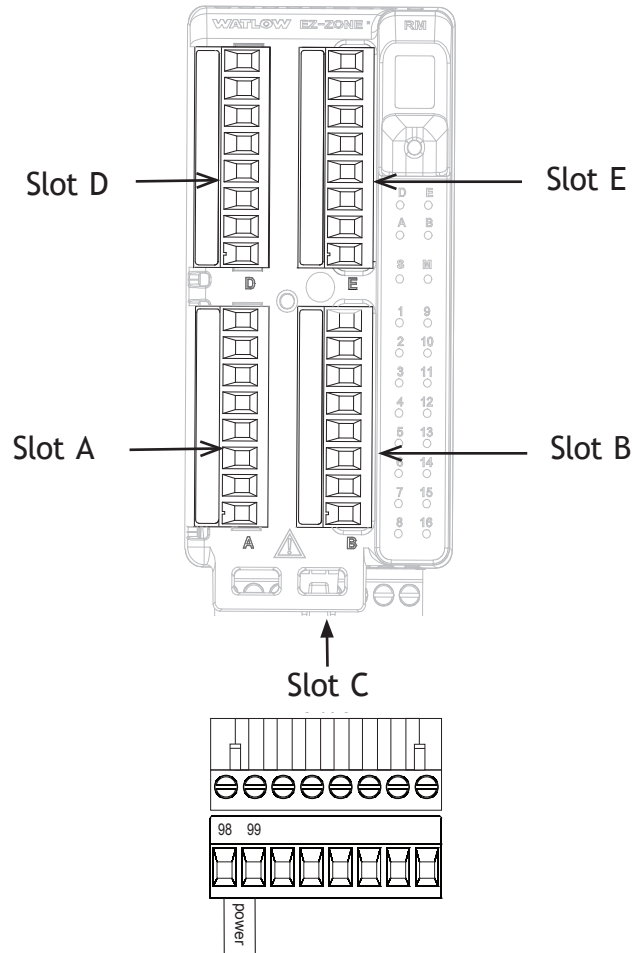

### RML System Isolation Blocks

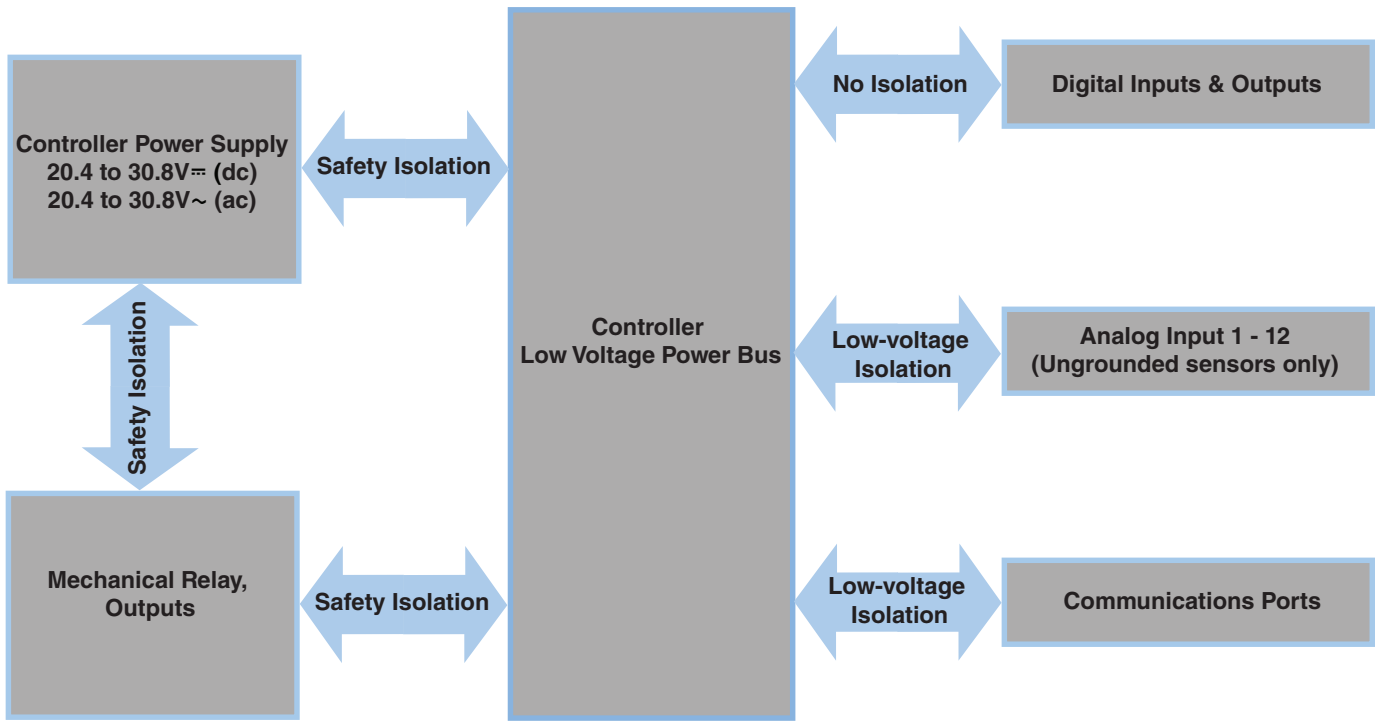

Low-voltage Isolation: 42V peak  
Safety Isolation: 1,528V~ (ac)

**Warning:** ⚠

Use National Electric (NEC) or other country-specific standard wiring and safety practices when wiring and connecting this controller to a power source and to electrical sensors or peripheral devices. Failure to do so may result in damage to equipment and property, and/or injury or loss of life.

**Note:**

Maximum wire size termination and torque rating:

- 0.0507 to 3.30 mm<sup>2</sup> (30 to 12 AWG) single-wire termination or two 1.31 mm<sup>2</sup> (16 AWG)
- 0.57 Nm (5.0 in-lb.) torque

**Note:**

Adjacent terminals may be labeled differently, depending on the model number.

**Note:**

To prevent damage to the controller, do not connect wires to unused terminals.

**Note:**

Maintain electrical isolation between digital input-outputs, switched dc/open collector outputs and process outputs to prevent ground loops.

## Controller Module Wiring (RMLx-xxxx-xxxx)

### Low Power

RML - All Model Numbers

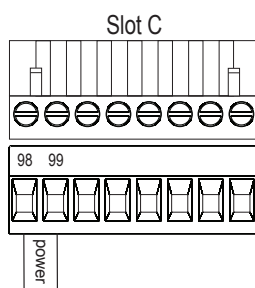

- 20.4 to 30.8 V ~ (ac) / ∞ (dc) 14VA
- 47 to 63 Hz
- Controller module power consumption, 7 Watts maximum
- 31 Watts maximum power available for P/S part #:0847-0299-0000
- 60 Watts maximum power available for P/S part #:0847-0300-0000
- 91 Watts maximum power available for P/S part #:0847-0301-0000
- Class 2 or Safety Extra Low Voltage (SELV) power source required to meet UL compliance standards

### Communications

RML Part # Digit 10 is A

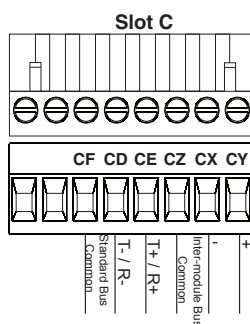

- CF, CD, CE - Standard Bus EIA485 Communications
- CZ, CX, CY - Inter-module Bus EIA485 Communications
- Do not route network wires with power wires. Connect network wires in daisy-chain fashion when connecting multiple devices in a network

### Communications

RML Part # Digit 10 is 1

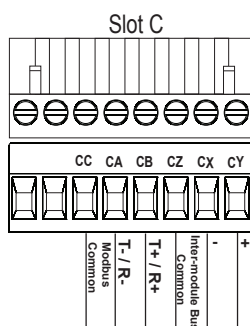

- CC, CA, CB - Modbus and Standard Bus EIA485 Communications (selectable via push button under zone address)
- CZ, CX, CY - Inter-module Bus EIA485 Communications
- Do not route network wires with power wires. Connect network wires in daisy-chain fashion when connecting multiple devices in a network

Modbus-IDA Terminal	EIA/TIA-485 Name	Watlow Terminal Label	Function
DO	A	CA or CD	T-/R-
D1	B	CB or CE	T+/R+
common	common	CC or CF	common

**Warning:** 

Use National Electric (NEC) or other country-specific standard wiring and safety practices when wiring and connecting this controller to a power source and to electrical sensors or peripheral devices. Failure to do so may result in damage to equipment and property, and/or injury or loss of life.

**Note:**

Maximum wire size termination and torque rating:

- 0.0507 to 3.30 mm<sup>2</sup> (30 to 12 AWG) single-wire termination or two 1.31 mm<sup>2</sup> (16 AWG)
- 0.57 Nm (5.0 in-lb.) torque

**Note:**

Adjacent terminals may be labeled differently, depending on the model number.

**Note:**

To prevent damage to the controller, do not connect wires to unused terminals.

**Note:**

Maintain electrical isolation between digital input-outputs, switched dc/open collector outputs and process outputs to prevent ground loops.

**Inputs 1 through 12 Thermocouple**

RML Part # Digits 5, 6, 7

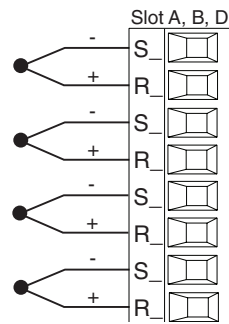

- 2K  $\Omega$  maximum source resistance
- >20 M $\Omega$  input impedance
- 3 microampere open-sensor detection
- Thermocouples are polarity sensitive. The negative lead (usually red) must be connected to S terminal
- To reduce errors, the extension wire for thermocouples must be of the same alloy as the thermocouple.
- Input 1 - 4: RMLx - (5)xxx - xxxx
- Input 5 - 8: RMLx - x(5)xx - xxxx
- Input 9 - 12: RMLx - xx(5)x - xxxx

**Inputs 1 through 12 RTD**

RML Part # Digits 5, 6, 7

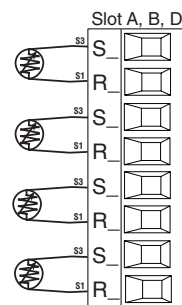

- Platinum, 100 and 1,000  $\Omega$  @ 0°C
- Calibration to DIN curve (0.00385  $\Omega/\Omega/^\circ\text{C}$ )
- 20  $\Omega$  total lead resistance
- RTD excitation current of 0.09 mA typical. Each ohm of lead resistance may affect the reading by 0.03°C for 100  $\Omega$ .

- Input 1 - 4: RMLx - (5)xxx - xxxx
- Input 5 - 8: RMLx - x(5)xx - xxxx
- Input 9 - 12: RMLx - xx(5)x - xxxx

AWG	Ohms/1000ft
14	2.575
16	4.094
18	6.510
20	10.35
22	16.46
24	26.17
26	41.62
28	66.17

**Inputs 1 through 12 Potentiometer**

RML Part # Digits 5, 6, 7

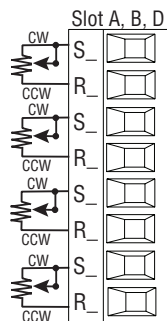

- Use a 1 k $\Omega$  potentiometer.
- Input 1 - 4: RMLx - (5)xxx - xxxx
- Input 5 - 8: RMLx - x(5)xx - xxxx
- Input 9 - 12: RMLx - xx(5)x - xxxx

**Inputs 1 through 12 Thermistor**

RML Part # Digits 5, 6, 7

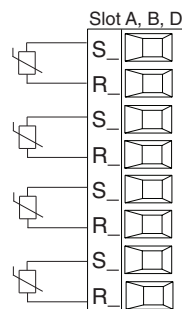

- >20 M $\Omega$  input impedance
- Input 1 - 4: RMLx - (6)xxx - xxxx
- Input 5 - 8: RMLx - x(6)xx - xxxx
- Input 9 - 12: RMLx - xx(6)x - xxxx



**Warning:** ⚠

Use National Electric (NEC) or other country-specific standard wiring and safety practices when wiring and connecting this controller to a power source and to electrical sensors or peripheral devices. Failure to do so may result in damage to equipment and property, and/or injury or loss of life.

**Note:**

Maximum wire size termination and torque rating:

- 0.0507 to 3.30 mm<sup>2</sup> (30 to 12 AWG) single-wire termination or two 1.31 mm<sup>2</sup> (16 AWG)
- 0.57 Nm (5.0 in-lb.) torque

**Note:**

Adjacent terminals may be labeled differently, depending on the model number.

**Note:**

To prevent damage to the controller, do not connect wires to unused terminals.

**Note:**

Maintain electrical isolation between digital input-outputs, switched dc/open collector outputs and process outputs to prevent ground loops.

**Digital Inputs 1 through 6 and 9**

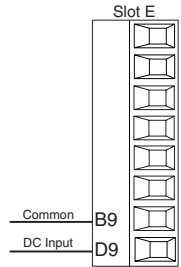
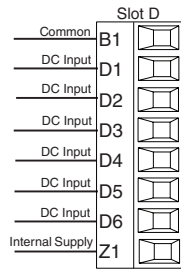

**Digital Input Event Conditions**

- Dry Contact
  - Input inactive when > 100KΩ
  - Input active when < 50Ω
- Voltage
  - Input inactive when < 2V
  - Input active when > 3V
- Six user configurable digital inputs/outputs per slot
  - Slot D, DI 1 - 6 RMLx-x(C)xx-xxxx
  - Slot E, DI 9 RMLx-xxx(B)-xxxx

**Note:**

When using a dry contact with Digital Input 9 (Slot E), notice that the connection is made between pins B9 and D9.

**RML Part # Digit 7, 8**

**Voltage Input**

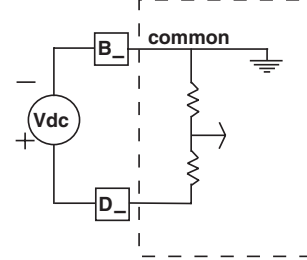

**Dry Contact**

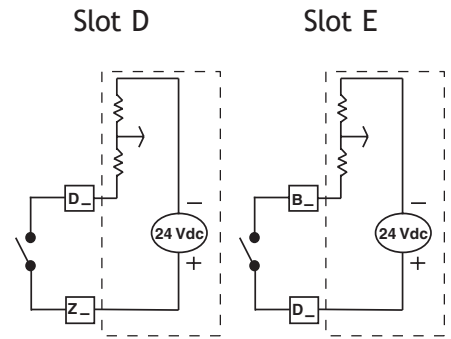

**Process Inputs 1 through 12**

**RML Part # Digits 5, 6, 7**

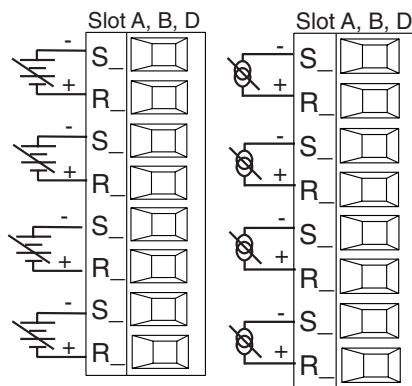

- 0 to 20mA @ 100 Ω input impedance
  - 0 to 10V<sub>rms</sub> (dc) @ 20kΩ input impedance
  - 0 to 50mV<sub>rms</sub> (dc) @ 20MΩ input impedance
  - Scalable
- Inputs 1 - 4: RMLx - (5)xxx - xxxx  
 Input 5 - 8: RMLx - x(5)xx - xxxx  
 Input 9 - 12: RMLx - xx(5)x - xxxx

**Warning:** 

Use National Electric (NEC) or other country-specific standard wiring and safety practices when wiring and connecting this controller to a power source and to electrical sensors or peripheral devices. Failure to do so may result in damage to equipment and property, and/or injury or loss of life.

**Note:**

Maximum wire size termination and torque rating:

- 0.0507 to 3.30 mm<sup>2</sup> (30 to 12 AWG) single-wire termination or two 1.31 mm<sup>2</sup> (16 AWG)
- 0.57 Nm (5.0 in-lb.) torque

**Note:**

Adjacent terminals may be labeled differently, depending on the model number.

**Note:**

To prevent damage to the controller, do not connect wires to unused terminals.

**Note:**

Maintain electrical isolation between digital input-outputs, switched dc/open collector outputs and process outputs to prevent ground loops.

**Quencharc Note:**

Switching pilot duty inductive loads (relay coils, solenoids, etc.) with the mechanical relay, solid state relay or open collector output options requires use of an R.C. suppressor.

**Digital Outputs 1 - 6**

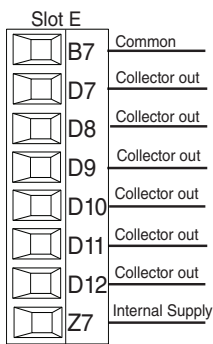

- Maximum switched voltage is 32V $\overline{\text{dc}}$
  - Internal supply provides a constant power output of 750mW
  - Maximum output sink current per output is 1.5A (external class 2 or \*SELV supply required)
  - Total sink current for all outputs not to exceed 8A
  - Do not connect outputs in parallel
    - Slot D DO 1 - 6 RMLx-xx(C)x-xxxx
- \*Safety Extra Low Voltage

**RML Part # Digit 7**

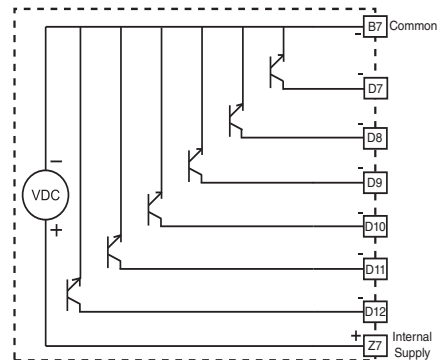

**Switched DC Wiring Example Using DO 1-6**

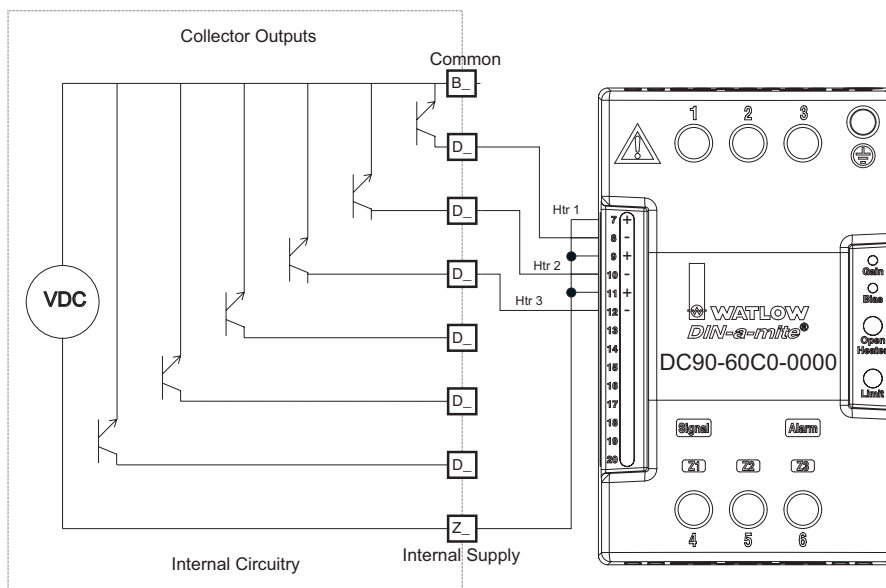

**Note:**

As a switched DC output; this output is a constant current output delivering 750 mW, current limited to 400 mA. The internal supply does have a maximum open circuit voltage of 22 VDC and minimum open circuit voltage of 19 VDC. Pin Z1 is shared to all digital outputs. This type of output is meant to drive solid-state-relays, not mechanical relays.

**Warning:** ⚠

Use National Electric (NEC) or other country-specific standard wiring and safety practices when wiring and connecting this controller to a power source and to electrical sensors or peripheral devices. Failure to do so may result in damage to equipment and property, and/or injury or loss of life.

**Note:**

- Maximum wire size termination and torque rating:
- 0.0507 to 3.30 mm<sup>2</sup> (30 to 12 AWG) single-wire termination or two 1.31 mm<sup>2</sup> (16 AWG)
  - 0.57 Nm (5.0 in.-lb.) torque

**Note:**

Adjacent terminals may be labeled differently, depending on the model number.

**Note:**

To prevent damage to the controller, do not connect wires to unused terminals.

**Note:**

Maintain electrical isolation between digital input-outputs, switched dc/open collector outputs and process outputs to prevent ground loops.

**Quencharc Note:**

Switching pilot duty inductive loads (relay coils, solenoids, etc.) with the mechanical relay, solid state relay or open collector output options requires use of an R.C. suppressor.

### Open Collector Wiring Example Using DO 1-6

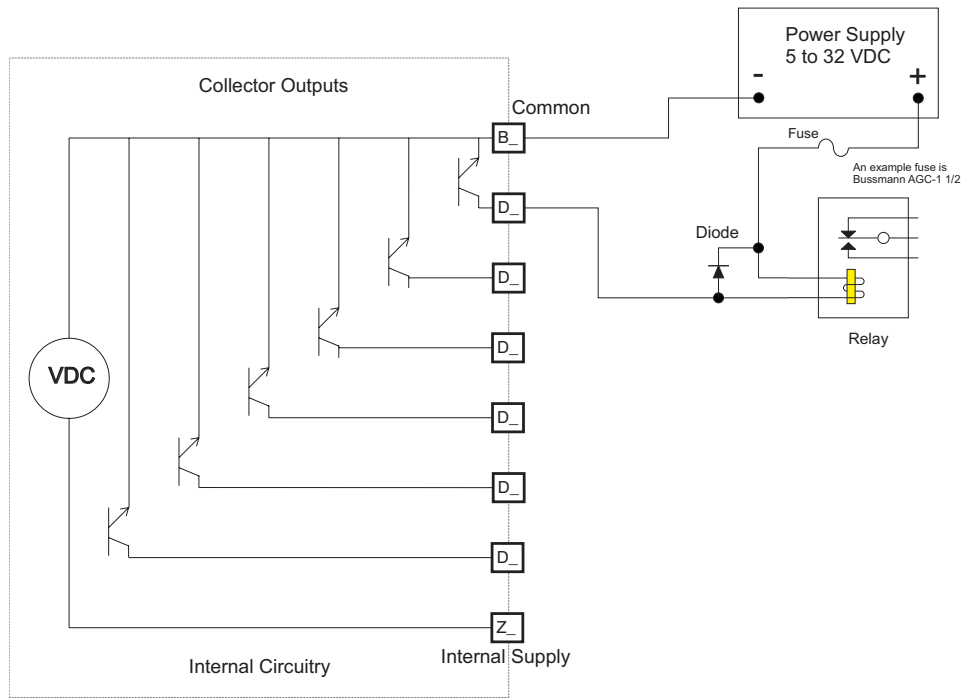

As an open collector output (see graphic below), use an external power supply with the negative wired to B1, the positive to the coil of a pilot mechanical relay and the other side of the coil wired to the output of choice (D<sub>-</sub>). Each open collector output can sink 1.5 A with the total for all open collector outputs not exceeding 8 amperes. Ensure that a kickback diode is reversed wired across the relay coil to prevent damage to the internal transistor.

### Output 1 - 4 and 7 - 10 Mechanical Relay, Form A

RML Part # Digit 7, 8

Slot D	Terminal	State
Slot D	L1	normally open
	K1	common
	L2	normally open
	K2	common
	L3	normally open
	K3	common
	L4	normally open
	K4	common

Slot E	Terminal	State
Slot E	L7	normally open
	K7	common
	L8	normally open
	K8	common
	L9	normally open
	K9	common
	L10	normally open
	K10	common

- 5 A at 240V~ (ac) or 30V= (dc) maximum resistive load
- 20 mA at 24V minimum load
- 125 VA pilot duty @ 120/240V~ (ac), 25 VA at 24V~ (ac)
- 100,000 cycles at rated load
- Output does not supply power.
- For use with ac or dc

Mechanical Relay Form A

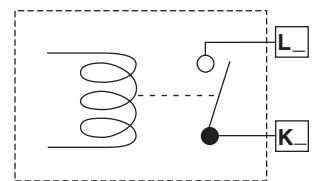

See Quencharc note.

- Slot D Outputs 1 - 6, RMLx-xx(J)x-xxxx
- Slot E Outputs 7 - 10, RMLx-xxx(J)-xxxx

**Warning:** 

Use National Electric (NEC) or other country-specific standard wiring and safety practices when wiring and connecting this controller to a power source and to electrical sensors or peripheral devices. Failure to do so may result in damage to equipment and property, and/or injury or loss of life.

**Note:**

Maximum wire size termination and torque rating:

- 0.0507 to 3.30 mm<sup>2</sup> (30 to 12 AWG) single-wire termination or two 1.31 mm<sup>2</sup> (16 AWG)
- 0.57 Nm (5.0 in-lb.) torque

**Note:**

Adjacent terminals may be labeled differently, depending on the model number.

**Note:**

To prevent damage to the controller, do not connect wires to unused terminals.

**Note:**

Maintain electrical isolation between digital input-outputs, switched dc/open collector outputs and process outputs to prevent ground loops.

**Quencharc Note:**

Switching pilot duty inductive loads (relay coils, solenoids, etc.) with the mechanical relay, solid state relay or open collector output options requires use of an R.C. suppressor.

### Output 7 and 8 Mechanical Relays, Form A

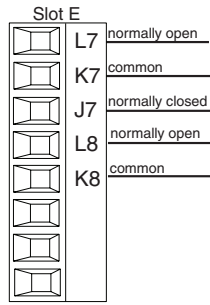

- 5 A at 240V~ (ac) or 30V= (dc) maximum resistive load
  - 20 mA at 24V minimum load
  - 125 VA pilot duty at 120/240V~ (ac), 25 VA at 24V~ (ac)
  - 100,000 cycles at rated load
  - Output does not supply power.
  - For use with ac or dc
- See Quencharc note.

- Slot E Output 7  
RMLx-xxx(B)-xxxx

- 5 A at 240V~ (ac) or 30V= (dc) maximum resistive load
  - 20 mA at 24V minimum load
  - 125 VA pilot duty @ 120/240V~ (ac), 25 VA at 24V~ (ac)
  - 100,000 cycles at rated load
  - Output does not supply power.
  - For use with ac or dc
- See Quencharc note.

- Slot E Output 8  
RMLx-xxx(B)-xxxx

### RML Part # Digit 8

#### Mechanical Relay Form C

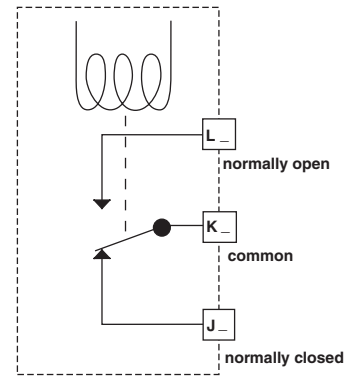

#### Mechanical Relay Form A

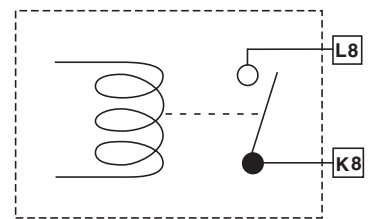

### Quencharc Wiring Example

In this example the Quencharc circuit (Watlow part# 0804-0147-0000) is used to protect RML internal circuitry from the counter electromagnetic force from the inductive user load when deenergized. It is recommended that this or an equivalent Quencharc be used when connecting inductive loads to RML outputs.

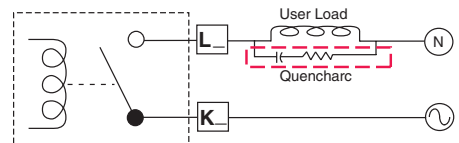

## Standard Bus EIA-485 Communications

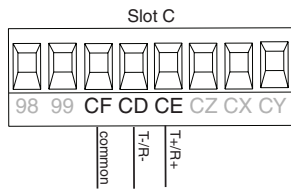

- Wire T-/R- to the A terminal of the EIA-485 port.
- Wire T+/R+ to the B terminal of the EIA-485 port.
- Wire common to the common terminal of the EIA-485 port.
- Do not route network wires with power wires. Connect network wires in daisy-chain fashion when connecting multiple devices in a network.
- A 120 Ω termination resistor may be required across T+/R+ and T-/R-, placed on the last controller on the network.
- Do not connect more than 16 EZ-ZONE RM modules on a network.
- Maximum network length: 1,200 meters (4,000 feet)
- 1/8th unit load on EIA-485 bus

RMLx-xxxx-x(A)xx

\*All models include Standard Bus communications

### Note:

Do not leave a USB to EIA-485 converter connected to Standard Bus without power (i.e., disconnecting the USB end from the computer while leaving the converter connected on Standard Bus). Disturbance on the Standard Bus may occur.

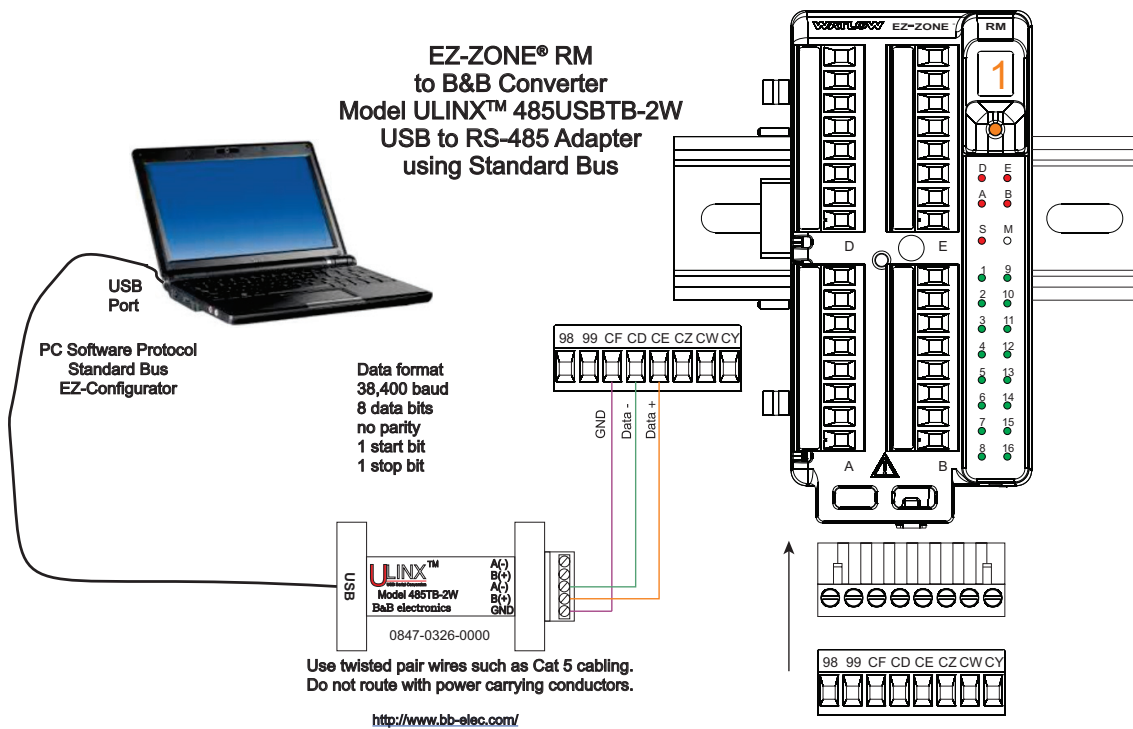

## EZ-ZONE<sup>®</sup> RM to Serial Gear Converter Model USB-COMi-M

Screw terminal connector pin-out:

- 1 is Data -(A), connects to pin CD or CA
- 2 is Data +(B), connects to pin CE or CB
- 6 is GND, connects to pin CF or CC

DB9 connector, EIA485 half duplex pin-out:

- 1 is Data -(A), connects to pin CD or CA
- 2 is Data +(B), connects to pin CE or CB
- 5 is GND, connects to pin CF or CC

DB9 connector, EIA232 pin-out:

- 1 is DCD
- 2 is RXD
- 3 is TXD
- 4 is DTR
- 5 is Gnd
- 6 is DSR

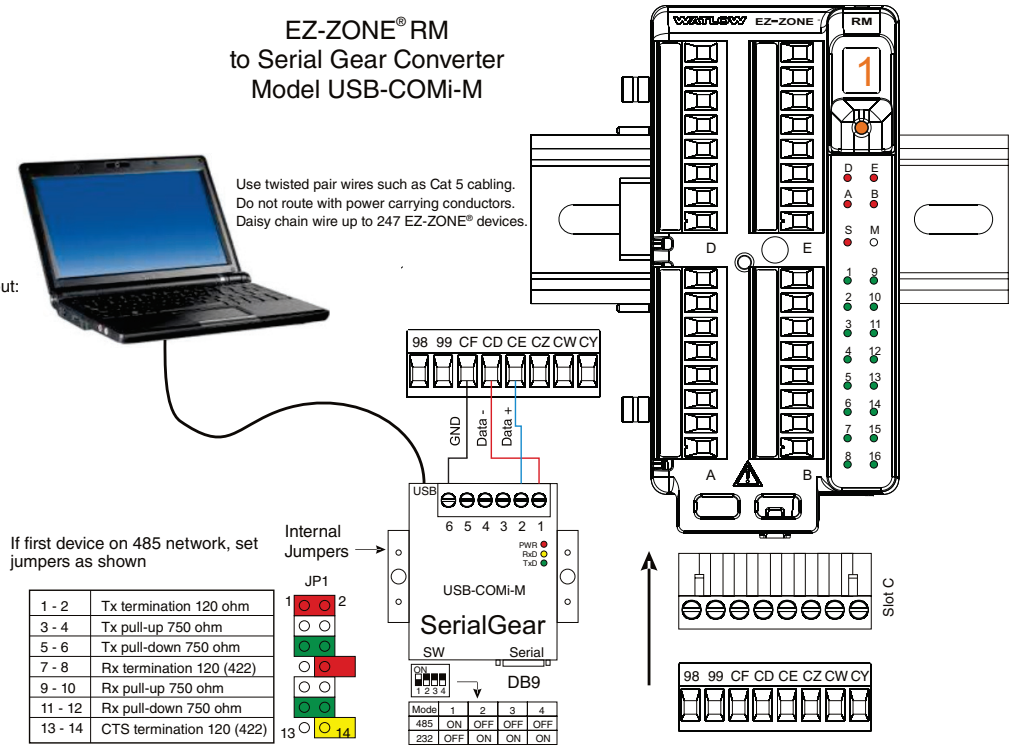

<http://serialgear.com/1-Port-Serial-USB-USB-COMi-M.html>

## Modbus RTU or Standard Bus EIA-485 Communications

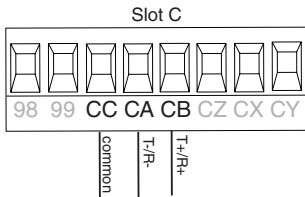

- • Wire T-/R- to the A terminal of the EIA-485 port.
  - • Wire T+/R+ to the B terminal of the EIA-485 port.
  - • Wire common to the common terminal of the EIA-485 port.
  - • Do not route network wires with power wires. Connect network wires in daisy-chain fashion when connecting multiple devices in a network.
  - • A termination resistor may be required. Place a 120 Ω resistor across T+/R+ and T-/R- of last controller on network.
  - • Only one protocol per port is available at a time: either Modbus RTU or Standard Bus.
  - • Do not connect more than 16 EZ-ZONE controllers on a Standard Bus network.
  - • Maximum number of EZ-ZONE controllers on a Modbus network is 247.
  - • Maximum network length: 1,200 meters (4,000 feet)
  - • 1/8th unit load on EIA-485 bus
- RMLx-xxxx-x(1)xx

Modbus-IDA Terminal	EIA/TIA-485 Name	Watlow Terminal Label	Function
DO	A	CA or CD	T-/R-
D1	B	CB or CE	T+/R+
common	common	CC or CF	common

**EZ-ZONE® RM  
to B&B Converter  
Model ULINX™ 485USB-2W  
USB to RS-485 Adapter  
using Modbus RTU**

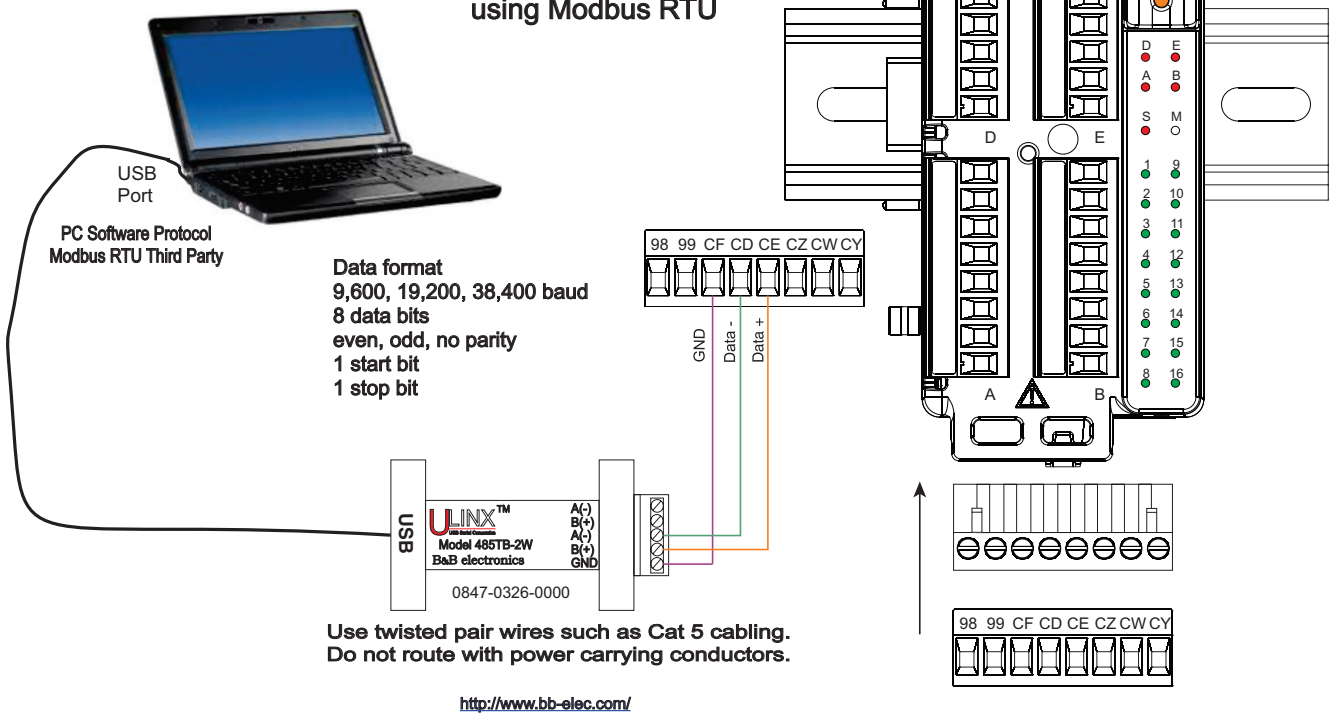

**Note:**

Do not leave a USB to EIA-485 converter connected to Standard Bus without power (i.e., disconnecting the USB end from the computer while leaving the converter connected on Standard Bus). Disturbance on the Standard Bus may occur.

**Note:**

When connecting the USB converter to the PC it is suggested that the Latency Timer be changed from the default of 16 msec to 1 msec. Failure to make this change may cause communication loss between the PC running EZ-ZONE Configurator or Composer software and the control.

*To modify Latency Timer settings follow the steps below:*

1. Navigate to Device Manager on the PC.
2. Double click on Ports.
3. Right click on the USB serial port in use and select Properties.
4. Click the tab labeled Port settings and then click the Advance button. The graphic above shows the advanced settings dialog box for the com port in use.

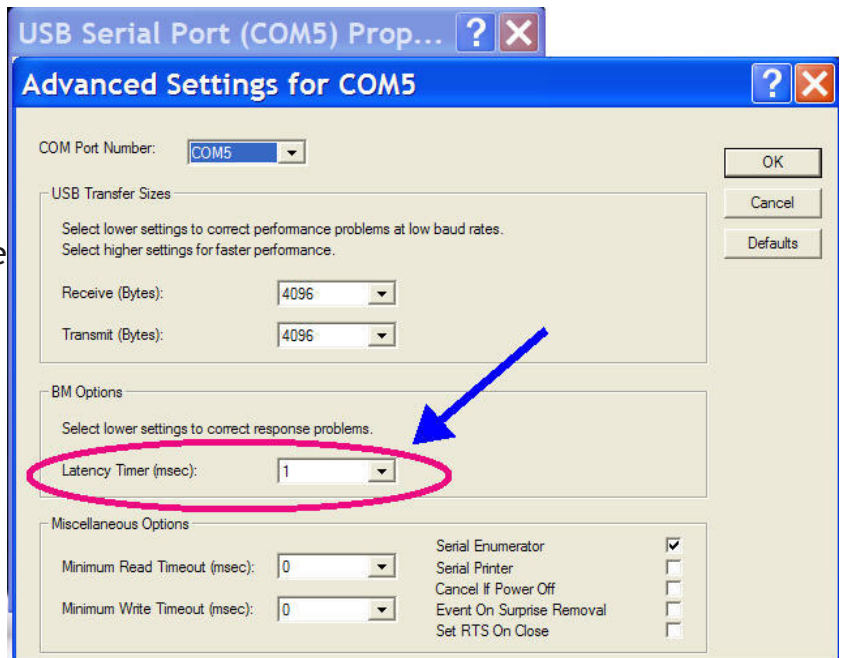

## Wiring a Serial EIA-485 Network

Do not route network wires with power wires. Connect network wires in daisy-chain fashion when connecting multiple devices in a network. A termination resistor may be required. Place a 120 Ω resistor across T+/R+ and T-/R- of the last controller on a network. Only one protocol per port is available at a time: either Modbus RTU or Standard Bus.

### Note:

Termination resistors when used, require a termination resistor at both ends of the network.

## A Network Using Watlow's Standard Bus and an RUI/Gateway

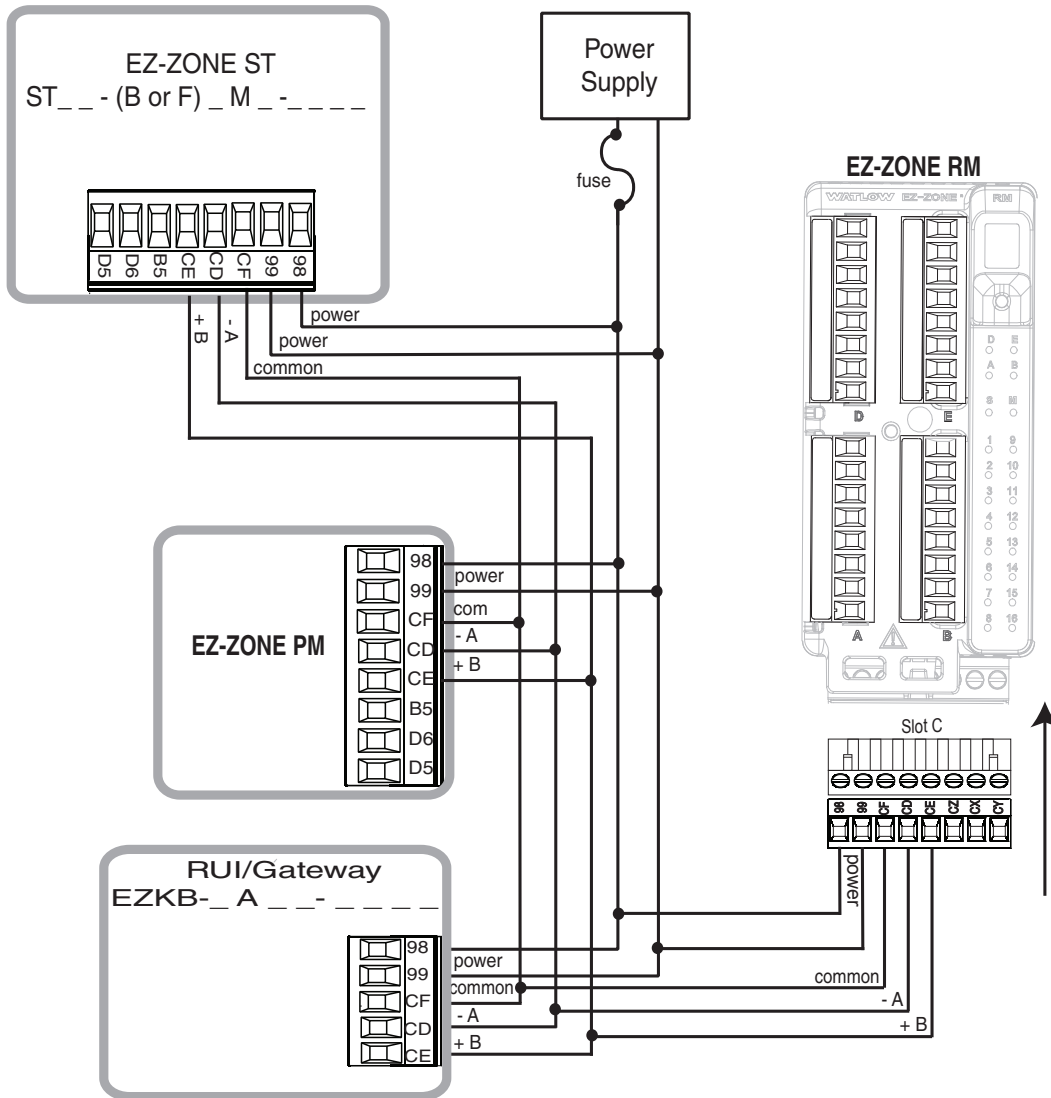



# A Network Using Modbus RTU

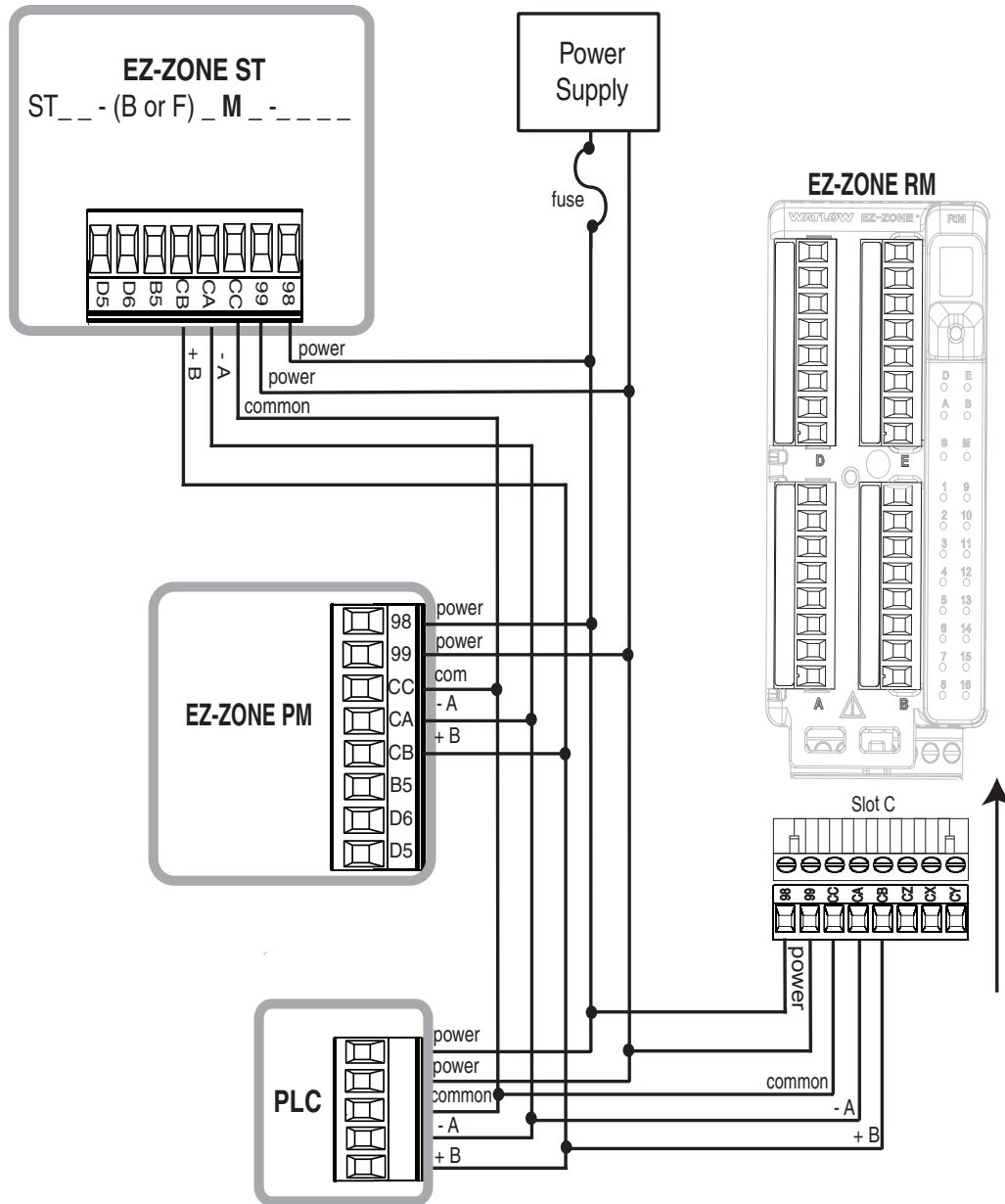

## Connecting the Modules

### RM System Connections

The RMC module can be installed as a stand-alone module or it can be interconnected on the DIN rail as shown below. When modules are connected together as shown, power and communications are shared between modules over the modular backplane interconnection (red circle). Therefore, bringing the necessary power and communications wiring to any one module (connector in slot C) is sufficient. The modular backplane interconnect comes standard with every module ordered and is generic in nature, meaning any of the RM modules can use it.

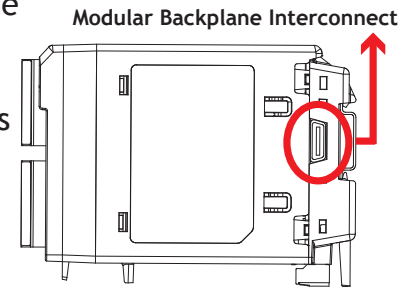

Notice in the split rail system diagram that a single power supply is being used across both DIN rails. One notable consideration when designing the hardware layout would be the available power supplied and the loading affect of all of the modules used. Watlow provides three options for power supplies listed below:

1. 90-264 Vac to 24Vdc @ 31 watts (Part #: 0847-0299-0000)
2. 90-264 Vac to 24Vdc @ 60 watts (Part #: 0847-0300-0000)
3. 90-264 Vac to 24Vdc @ 91 watts (Part #: 0847-0301-0000)

With regards to the modular loading affect, maximum power for each is listed below:

1. RMCxxxxxxxxxxxx @ 7 watts / 14VA
2. RMEx-xxxx-xxxx @ 7 watts / 14VA
3. RMAx-xxxx-xxxx @ 4 watts / 9VA
4. RMLx-xxxx-xxxx @ 7 watts / 14VA
5. RMHx-xxxx-xxxx @ 7 watts / 14VA
6. RMSx-xxxx-xxxx @ 7 watts / 14VA

So, in the split rail system diagram, the maximum current draw on the supply would be 38 Watts.

- 2 RMC modules consumes 7W
- 1 RML modules consumes 7W
- 1 RME module consumes 4W
- 1 RMA modules consumes 7W
- 1 Remote User Interface consumes 6W

With this power requirement (38 watts) the second or third power supply could be used.

Another hardware configuration scenario that could present itself (graphic not shown) would be a configuration that requires more than one supply. Lets make some assumptions pertaining to the split rail system diagram shown below. The power supply used is the 91W supply. The top DIN rail now has the following modules:

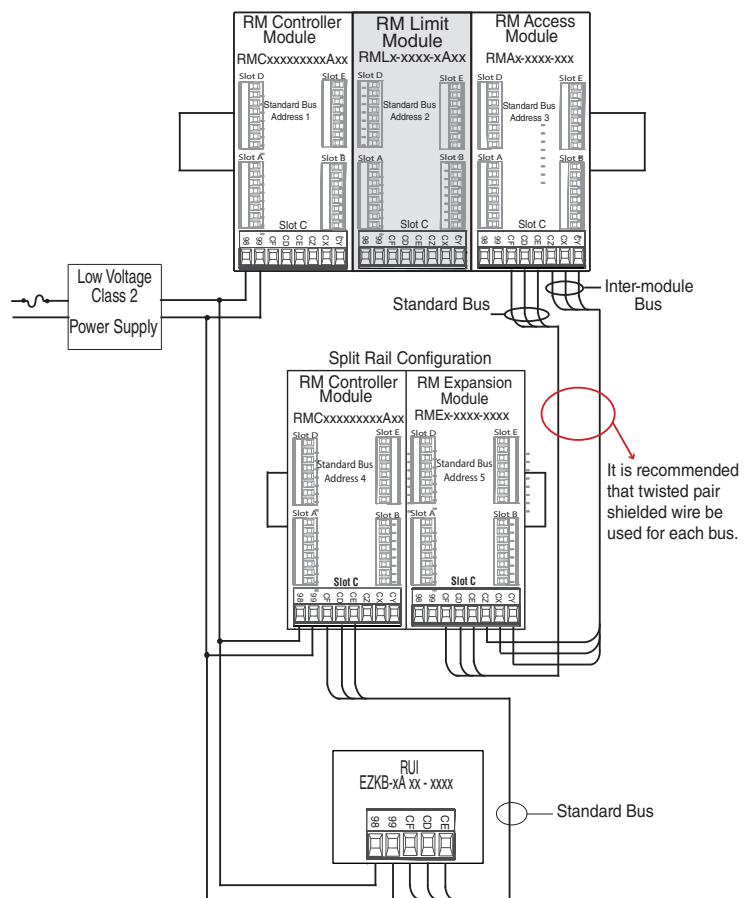

- 2 RMC modules consumes 14W
- 1 RMA consumes 4W
- 11 RME modules consumes 77W
- **2 RML modules consumes 14W**

As can now be seen, the total power requirement exceeds 91W. In this case, another power supply would be required. To incorporate another supply in this system simply disconnect pins 99 and 98 on the remote DIN rail and connect another appropriately sized power supply for the remote modules to those same pins.

When using a split rail configuration ensure that the interconnections for the Inter-module Bus and Standard Bus do not exceed 200 feet. Standard Bus and the Inter-module Buses are different protocols and both are required for split rail configurations. Without having both connected, communications between modules would not be possible.

**Note:**

Unit is not provided with a disconnect, use of an external disconnect is required. It should be located in close proximity to the unit and be labeled as the disconnect for the unit.

**Note:**

Connecting power supplies in parallel is not allowed. When power consumption is greater than 91 watts use a split rail configuration.

## Conventions Used in the Menu Pages

To better understand the menu pages that follow review the naming conventions used. When encountered throughout this document, the word "default" implies as shipped from the factory. Each page (Operations, Setup, Profile and Factory) and their associated menus have identical headers defined below:

Header Name	Definition
Display	Visually displayed information from the control.
Parameter Name	Describes the function of the given parameter.
Range	Defines options available for this prompt, i.e., min/max values (numerical), yes/no, etc... (further explanation below).
Default	Values as delivered from the factory.
Modbus Relative Address	Identifies unique parameters using either the Modbus RTU or Modbus TCP protocols (further explanation below).
CIP (Common Industrial Protocol)	If used in conjunction with an RMA module identifies unique parameters using either the DeviceNet or EtherNet/IP protocol (further explanation below).
Profibus Index	If used in conjunction with an RMA module identifies unique parameters using Profibus DP protocol (further explanation below).
Parameter ID	Identifies unique parameters used with other software such as, LabVIEW.
Data Type and Access (R/W)	uint = Unsigned 16 bit integer dint = Signed 32-bit, long string = ASCII (8 bits per character) float = IEEE 754 32-bit RWES = Readable Writable EEPROM (saved) User Set (saved)

### Display

When the RML module is used in conjunction with the RUI (optional equipment) visual information from the control is displayed to the observer using a fairly standard 7 segment display. Due to the use of this technology, several characters displayed need some interpretation, see the list below:

<i>1</i> = 1	<i>7</i> = 7	<i>c, E</i> = c	<i>i</i> = i	<i>o</i> = o	<i>u</i> = u
<i>2</i> = 2	<i>8</i> = 8	<i>d</i> = d	<i>J</i> = J	<i>P</i> = P	<i>v</i> = v
<i>3</i> = 3	<i>9</i> = 9	<i>E</i> = E	<i>H</i> = K	<i>q</i> = q	<i>LJ</i> = W
<i>4</i> = 4	<i>0</i> = 0	<i>F</i> = F	<i>L</i> = L	<i>r</i> = r	<i>y</i> = y
<i>5</i> = 5	<i>A</i> = A	<i>g</i> = g	<i>π 7</i> = M	<i>S</i> = S	<i>Z</i> = Z
<i>6</i> = 6	<i>b</i> = b	<i>h</i> = h	<i>n</i> = n	<i>t</i> = t	

## Range

Within this column notice that on occasion there will be numbers found within parenthesis. This number represents the enumerated value for that particular selection. Range selections can be made simply by writing the enumerated value of choice using any of the available communications protocols. As an example, turn to the Setup Page and look at the Analog Input menu and then the Sensor Type. To turn the sensor off using Modbus simply write the value of 62 (off) to register 418 and send that value to the control.

### Note:

With firmware release 9.0 and above, two new parameters (Minimum and Maximum) were added to allow ranges to be opened up to display full values. Unsigned integer may take on a range of 0 to 65,535 and floating point may take on a range of  $-3.4E+38$  to  $3.4E+38$ . Prior to revision 9.0, ranges were clamped to accommodate the seven segment LED display of the RUI. Both of these new parameters can be found in the Setup Page under the Global Menu.

---

## Communication Protocols

All modules come with the standard offering of Watlow's Standard Bus protocol used primarily for inter-module communications as well as for configuration using EZ-ZONE Configurator or Composer software (free download from Watlow's web site (<http://www.watlow.com>)). Along with Standard Bus, the RML module can also be ordered with Modbus RTU (only one protocol can be active at any given time). The RMA module has options for several different protocols listed below:

- Modbus RTU 232/485
- EtherNet/IP, Modbus TCP
- DeviceNet
- Profibus DP

To learn more about the RM Access module click on the link below. Once there simply type in RM in the Keyword field. <http://www.watlow.com/literature/manuals.cfm>

---

## Modbus RTU Protocol

All Modbus registers are 16-bits and as displayed in this manual are relative addresses (actual). Some legacy software packages limit available Modbus registers to 40001 to 49999 (5 digits). Many applications today require access to all available Modbus registers which range from 400001 to 465535 (6 digits). Watlow controls support 6 digit Modbus registers.

### Note:

In this User's Guide all values shown representing Modbus addresses are added to 400,001 or 40,001 to acquire the absolute address. As an example, notice above (under the Range header) the Modbus address identified for Sensor type. Compare this to the value listed for this same parameter found in the Setup Page under the Analog Input Menu.

For parameters listed as float notice that only one (low order) of the two registers is listed, this is true throughout this document. By default, the low order word contains the two low bytes of the 32-bit parameter. As an example, look in the Operations Page for the Analog Input Value. Find the column identified in the header as Modbus and notice that it lists register 410. Because this parameter is a float it is actually represented by registers 410 (low order bytes) and 411 (high order bytes). The Modbus specification does not dictate which register should be high or low order so Watlow provides the user the ability to swap this order (Setup Page, Communications Menu) from the default low/high to high/low.

It should also be noted that some of the cells in the Modbus column contain wording pertaining to an offset. Several parameters in the control contain more than one instance; such as, alarms (16), analog inputs (12), etc... The Modbus register shown always represents instance one. Take for an example the Silencing parameter found in the Setup Pages under the Alarm menu. Instance one is shown as address 2540 and the offset to the next instance is identified as +60. If there was a desire to read or write to instance 3 simply add 120 to 2540 to find its address, in this case, the instance 3 address for Alarm Silence is 2660.

RMLx - xxxx - A[1]AA

or

RMA \_ - A [2, 3] \_ \_ - A A \_

or

EZKB - x [2,3] \_ \_ - \_ \_ \_ \_

To learn more about the Modbus protocol point your browser to <http://www.modbus.org>.

# 3

## Chapter 3: Operations Pages

### Control Module Operation Page Parameters

To navigate to the Operations Page using the RUI, follow the steps below:

1. From the Home Page, press both the Up ▲ and Down ▼ keys for three seconds. *A I* will appear in the upper display and *oPEr* will appear in the lower display.
2. Press the Up ▲ or Down ▼ key to view available menus.
3. Press the Advance Key ⏩ to enter the menu of choice.
4. If a submenu exists (more than one instance), press the Up ▲ or Down ▼ key to select and then press the Advance Key ⏩ to enter.
5. Press the Up ▲ or Down ▼ key to move through available menu prompts.
6. Press the Infinity Key ∞ to move backwards through the levels: parameter to submenu, submenu to menu, menu to Home Page.
7. Press and hold the Infinity Key ∞ for two seconds to return to the Home Page.

On the following pages, top level menus are identified with a yellow background color.

#### Note:

Some of these menus and parameters may not appear, depending on the controller's options. See model number information in the Appendix for more information. If there is only one instance of a menu, no submenus will appear.

#### Note:

Some of the listed parameters may not be visible. Parameter visibility is dependent upon controller part number.

#### Note:

Some values will be rounded off to fit in the four-character RUI display. Full values can be read with other interfaces. In firmware 9.0 and above, a user may specify ranges greater than may displayed by an RUI. If greater or less than an RUI can display, the display will show Value High *vALH* or Value Low *vALL*.

*A I*  
*oPEr* Analog Input Menu

|

*A I* Analog Input (1 to 12)

*A In* Analog Input Value

*iEr* Input Error

*iCR* Calibration Offset

*d i o*  
*oPEr* Digital Input/Output Menu

|

*d i o* Digital Input/Output (1 to 6 and 9)

*doS* Output State

*diS* Input State

*ACT*  
*oPEr* Action Menu

|

*ACT* Action (1 to 16)

*E iS* Event Status

*L iM*  
*oPEr* Limit Menu

|

*L iM* Limit (1 to 4)

*LLS* Low Limit Set Point

*LHS* High Limit Set Point

*LCr* Clear Limit  
*LSt* Limit Status

### *ALPr*

*oPEr* Alarm Menu

|

*ALPr* Alarm (1 to 16)

*ALo* Low Set Point

*Ahi* High Set Point

*ACLr* Clear Alarm

*ASir* Silence Alarm

*ASt* Alarm State

### *Lnr*

*oPEr* Linearization Menu

|

*Lnr* Linearization (1 to 4)

*SuA* Source Value A

*oFSt* Offset

*ou* Output Value

### *CPE*

*oPEr* Compare Menu

|

*CPE* Compare (1 to 24)

*SuA* Source Value A

*SuB* Source Value B

*ou* Output Value

### *tPr*

*oPEr* Timer Menu

|

*tPr* Timer (1 to 24)

*SuA* Source Value A

*SuB* Source Value B

*Et* Elapsed Time

*ou* Output Value

### *Ctr*

*oPEr* Counter Menu

|

*Ctr* Counter (1 to 24)

*Cnt* Count

*SuA* Source Value A

*SuB* Source Value B

*ou* Output Value

### *L9C*

*oPEr* Logic Menu

|

*L9C* Logic (1 to 24)

*SuA* Source Value A

*SuB* Source Value B

*SuC* Source Value C

*SuD* Source Value D

*SuE* Source Value E

*SuF* Source Value F

*SuG* Source Value G

*SuH* Source Value H

*ou* Output Value

### *PrMt*

*oPEr* Math Menu

|

*PrMt* Math (1 to 24)

*SuA* Source Value A

*SuB* Source Value B

*SuC* Source Value C

*SuD* Source Value D

*SuE* Source Value E

*oFSt* Offset

*ou* Output Value



**RM Limit Module • Operations Page**

Display	Parameter Name Description	Range	Default	Modbus Relative Address	CIP Class Instance Attribute hex (dec)	Pro-fibus Index	Parameter ID	Data Type and Access **
<p><i>A i</i> <i>oPEr</i> <b>Analog Input Menu</b></p>								
<i>A i n</i> Ain	<i>Analog Input (1 to 12)</i> <b>Value</b> View the process value.  <b>Note:</b> Ensure that the Error Status (below) indicates no error (61) when reading this value using a field bus protocol. If an error exists, the last known value prior to the error occurring will be returned.	-1,999.000 to 9,999.000 °F or units -1,128.000 to 5,537.000 °C	- - - -	410 [offset 90]	0x68 (104) 1 to 12 1	0	4001	float R
<i>P u F</i> Pu.F	<i>Analog Input (1 to 12)</i> <b>Filtered Process Value</b> View the process value when filtering is turned on.	-1,999.000 to 9,999.000 °F or units -1,128.000 to 5,537.000 °C	- - - -	452 [offset 90]	0x68 (104) 1 to 12 0x16 (22)	- - - -	4022	float R
<i>i.Er</i> i.Er	<i>Analog Input (1 to 12)</i> <b>Error Status</b> View the cause of the most recent error. If the <i>REt n</i> message is <i>Er. 11</i> to <i>Er. 19</i> or <i>Er. 10</i> to <i>Er. 12</i> , this parameter will display the cause of the input error.	<i>nonE</i> None (61) <i>OPEn</i> Open (65) <i>Shrt</i> Shorted (127) <i>EPn</i> Measurement Error (140) <i>ECAL</i> Bad Calibration Data (139) <i>Er.Ab</i> Ambient Error (9) <i>ErEd</i> RTD Error (141) <i>FR iL</i> Fail (32)	- - - -	412 [offset 90]	0x68 (104) 1 to 12 2	1	4002	uint R
<i>i.CA</i> i.CA	<i>Analog Input (1 to 12)</i> <b>Calibration Offset</b> Offset the input reading to compensate for lead wire resistance or other factors that cause the input reading to vary from the actual process value.	-1,999.000 to 9,999.000 °F or units -1,110.555 to 5,555.000 °C	0.0	432 [offset 90]	0x68 (104) 1 to 12 0xC (12)	2	4012	float RWES

\* These parameters/prompts are available in these menus with firmware revisions 6.0 and above.

\*\* R: Read, W: Write, E: EEPROM, S: User Set

**RM Limit Module • Operations Page**

Display	Parameter Name Description	Range	Default	Modbus Relative Address	CIP Class Instance Attribute hex (dec)	Pro-fibus Index	Parameter ID	Data Type and Access **
No Display	<i>Analog Input (1 to 12)</i> <b>Clear Error</b> Clear latched input when input error condition no longer exists.	Clear Error (1221)	- - - -	466 [offset 90]	0x68 (104) 1 to 12 0x1D (29)	- - - -	4029	uint RW

*di o*  
*oPEr*

**Digital Input/Output Menu**

<i>do.S</i> do.S	<i>Digital Output (1 to 6 and 9)</i> <b>Output State</b> View the state of this output.	<i>oFF</i> Off (62) <i>oN</i> On (63)	- - - -	1862 [offset 30]	0x6A (106) 1 to 9 7	46	6007	uint R
<i>di.S</i> di.S	<i>Digital Input (1 to 6 and 9)</i> <b>Input State</b> View this event input state.	<i>oFF</i> Off (62) <i>oN</i> On (63)	- - - -	1870 [offset 30]	0x6A (106) 1 to 9 0x0B (11)	- - - -	6011	uint R
No Display	<i>Digital Input (1 to 6 and 9)</i> <b>Source Error</b> View reported cause for input malfunction.	None (61) Open (65) Shorted (127) Measurement error (140) Bad calibration data (139) Ambient error (9) RTD error (14) Fail (32) Math error (1423) Not sourced (246) Stale (1617)	- - - -	1878 [offset 30]	0x6A (106) 1 to 9 0x0F (15)	- - - -	6015	uint R
No Display	<i>Digital Input (1 to 6 and 9)</i> <b>Source Value A</b> View the value of source A	-1,999.000 to 9,999.000°F or units -1,128.000 to 5,537.000°C	- - - -	1874 [offset 30]	0x6A (106) 1 to 9 0x0D (13)	- - - -	6013	float R

*Act*  
*oPEr*

**Action Menu**

<i>Ei.S</i> Ei.S	<i>Action (1 to 16)</i> <b>Event Input Status</b> View this input state.	<i>oFF</i> Off (62) <i>oN</i> On (63)	- - - -	2218 [offset 20]	0x6E (110) 1 to 16 5	140	10005	uint R
---------------------	--	--	---------	---------------------	-------------------------------	-----	-------	-----------

\* These parameters/prompts are available in these menus with firmware revisions 6.0 and above.

\*\* R: Read, W: Write, E: EEPROM, S: User Set

**RM Limit Module • Operations Page**

Display	Parameter Name Description	Range	Default	Modbus Relative Address	CIP Class Instance Attribute hex (dec)	Pro-fibus Index	Parameter ID	Data Type and Access **
No Display	<i>Function Key (1)</i> <b>Function Key State</b> View current state of function key 1.	Off (62) On (63)	-----	-----	-----	-----	3024	uint R
No Display	<i>Function Key (2)</i> <b>Function Key State</b> View current state of function key 2.	Off (62) On (63)	-----	-----	-----	-----	3030	uint R
<p><i>L I M I T</i> <i>o P E R</i> <b>Limit Menu</b></p>								
<i>LLS</i> LL.S	<i>Limit (1 to 12)</i> <b>Low Limit Set Point</b> Set the low process value that will trigger the limit.	-1,999.000 to 9,999.000 °F or units -1,128.000 to 5,537.000 °C	0.0 °F or units -18.0 °C	1494 [offset 30]	0x70 (112) 1 to 123	38	12003	float RWES
<i>LhS</i> Lh.S	<i>Limit (1 to 12)</i> <b>High Limit Set Point</b> Set the high process value that will trigger the limit.	-1,999.000 to 9,999.000 °F or units -1,128.000 to 5,537.000 °C	0.0 °F or units -18.0 °C	1496 [offset 30]	0x70 (112) 1 to 124	39	12004	float RWES
<i>LCr</i> LCr	<i>Limit (1 to 12)</i> <b>Clear Limit *</b> Clear limit once limit condition is cleared.	Clear (129) Ignore (204)	-----	720 [offset 30]	0x70 (112) 1 to 121	-----	12001	uint W
<i>LSt</i> L.St	<i>Limit (1 to 12)</i> <b>Status *</b> Reflects whether or not the limit is in a safe or failed mode..	<i>FAIL</i> Fail (32) <i>SAFE</i> Safe (1667)	-----	1514 [offset 30]	0x70 (112) 1 to 12 0x0D (13)	-----	12013	uint R
No Display	<i>Limit (1 to 12)</i> <b>Limit State</b> Clear limit once limit condition is cleared.	Off (62) None (61) Limit High (51) Limit Low (52) Error (225)	-----	1500 [offset 30]	0x70 (112) 1 to 126	-----	12006	uint R
No Display	<i>Limit (1 to 12)</i> <b>Output Value</b> Current output state.	On (63) Off (62)	-----	1502 [offset 30]	0x70 (112) 1 to 0xC (12) 7	-----	12007	uint R

\* These parameters/prompts are available in these menus with firmware revisions 6.0 and above.

\*\* R: Read, W: Write, E: EEPROM, S: User Set

**RM Limit Module • Operations Page**

Display	Parameter Name Description	Range	Default	Modbus Relative Address	CIP Class Instance Attribute hex (dec)	Pro-fibus Index	Parameter ID	Data Type and Access **
<p><i>ALM</i> <i>oPEr</i> <b>Alarm Menu</b></p>								
<i>ALo</i> A.Lo	<i>Alarm (1 to 16)</i> <b>Low Set Point</b> If Type (Setup Page, Alarm Menu) is set to:  <b>Process</b> - set the process value that will trigger a low alarm.	-1,999.000 to 9,999.000°F or units -1,128.000 to 5,537.000°C	32.0°F or units 0.0°C	2532 [offset 60]	0x6D (109) 1 to 16 2	18	9002	float RWES
<i>ALh</i> A.hi	<i>Alarm (1 to 16)</i> <b>High Set Point</b> If Type (Setup Page, Alarm Menu) is set to:  <b>Process</b> - set the process value that will trigger a high alarm.	-1,999.000 to 9,999.000°F or units -1,128.000 to 5,537.000°C	300.0°F or units 150.0°C	2530 [offset 60]	0x6D (109) 1 to 16 1	19	9001	float RWES
<i>ALCLr</i> A.Clr	<i>Alarm (1 to 16)</i> <b>Clear Alarm</b> Write to this register to clear an alarm	0	- - - -	- - - -	- - - -	- - - -	9026	uint W
<i>ALSir</i> A.Sir	<i>Alarm (1 to 16)</i> <b>Silence Alarm</b> Write to this register to silence an alarm	0	- - - -	- - - -	- - - -	- - - -	9027	uint W
<i>ALSt</i> A.St	<i>Alarm (1 to 16)</i> <b>Alarm State</b> Current state of alarm	<i>Str</i> Startup (88) <i>nonE</i> None (61) <i>BLo</i> Blocked (12) <i>ALL</i> Alarm Low (8) <i>ALh</i> Alarm High (7) <i>ALe</i> Error (28)	- - - -	2546 [offset 60]	0x6D (109) 1 to 16 9	- - - -	9009	uint R
No Display	<i>Alarm (1 to 16)</i> <b>Alarm Clearable</b> Read to see if alarm can be cleared.	<i>no</i> No (59) <i>YES</i> Yes (106)	- - - -	2552 [offset 60]	0x6D (109) 1 to 16 0xC (12)	- - - -	9012	uint R
No Display	<i>Alarm (1 to 16)</i> <b>Silenced</b> Read to see if alarm is active but has been silenced by Silence Alarm.	Yes (106) No (59)	- - - -	2550 [offset 60]	0x6D (109) 1 to 16 0x0B (11)	- - - -	9011	uint R

\* These parameters/prompts are available in these menus with firmware revisions 6.0 and above.  
\*\* R: Read, W: Write, E: EEPROM, S: User Set

**RM Limit Module • Operations Page**

Display	Parameter Name Description	Range	Default	Modbus Relative Address	CIP Class Instance Attribute hex (dec)	Pro-fibus Index	Parameter ID	Data Type and Access **
No Display	<i>Alarm (1 to 16)</i> <b>Latched</b> Read to see if alarm is currently latched.	Yes (106) No (59)	- - - -	2548 [offset 60]	0x6D (109) 1 to 16 0x0A (10)	- - - -	9010	uint R
No Display	<i>Alarm (1 to 16)</i> <b>Clear Request</b> Write to this register to clear an alarm	Clear (0) No Change (255)	- - - -	2554 [offset 60]	0x6D (109) 1 to 16 0xD (13)	32	9013	uint RW
No Display	<i>Alarm (1 to 16)</i> <b>Silence Request</b> Write to this register to silence an alarm	Clear (0) No Change (255)	- - - -	2556 [offset 60]	0x6D (109) 1 to 16 0x0E (14)	33	9014	uint RW
No Display	<i>Alarm (1 to 16)</i> <b>Alarm Working Process Value</b> Read process value used by alarms	-1,999.000 to 9,999.000°F or units -1,128.000 to 5,537.000°C	- - - -	2566 [offset 60]	0x6D (109) 1 to 16 0x13 (19)	- - - -	9019	float R
No Display	<i>Alarm (1 to 16)</i> <b>Output Value</b> Read state of alarm output	On (63) Off (62)	- - - -	2576 [offset 60]	0x6D (109) 1 to 16 0x18 (24)	- - - -	9024	uint R

*Lnr*  
*oPEr*

**Linearization Menu**

<i>SuA</i> Su.A	<i>Linearization (1 to 16)</i> <b>Source Value A</b> View the value of Source A.	-1,999.000 to 9,999.000°F or units -1,128.000 to 5,537.000°C	- - - -	7996 [offset 70]	0x86 (134) 1 to 16 4	- - - -	34004	float R
<i>oFSt</i> oFSt	<i>Linearization (1 to 16)</i> <b>Offset</b> Set an offset to be applied to this function's output.	-1,999.000 to 9,999.000°F or units -1,128.000 to 5,537.000°C	0	8000 [offset 70]	0x86 (134) 1 to 16 6	- - - -	34006	float RWES
<i>oV</i> o.V	<i>Linearization (1 to 16)</i> <b>Output Value</b> View the value of this function's output.	-1,999.000 to 9,999.000°F or units -1,128.000 to 5,537.000°C	- - - -	8002 [offset 70]	0x86 (134) 1 to 16 7	- - - -	34007	float R

\* These parameters/prompts are available in these menus with firmware revisions 6.0 and above.

\*\* R: Read, W: Write, E: EEPROM, S: User Set

**RM Limit Module • Operations Page**

Display	Parameter Name Description	Range	Default	Modbus Relative Address	CIP Class Instance Attribute hex (dec)	Pro-fibus Index	Parameter ID	Data Type and Access **
No Display	<i>Linearization (1 to 16)</i> <b>Error</b> View reported cause for Linearization output malfunction.	None (61) Open (65) Shorted (127) Measurement error (140) Bad calibration data (139) Ambient error (9) RTD error (14) Fail (32) Math error (1423) Not sourced (246) Stale (1617) Can't process (1659)	- - - -	8044 [offset 70]	0x86 (134) 1 to 16 0x1C (28)	- - - -	34028	uint R
<p><i>CPE</i> <i>oPEr</i> <b>Compare Menu</b></p>								
<i>Su.A</i> Su.A	<i>Compare (1 to 16)</i> <b>Source Value A</b> View the value of Source A.	-1,999.000 to 9,999.000°F or units -1,128.000 to 5,537.000°C	- - - -	5922 [offset 40]	0x80 (128) 1 to 16 7	- - - -	28007	float R
<i>Su.b</i> Su.b	<i>Compare (1 to 16)</i> <b>Source Value B</b> View the value of Source B.	-1,999.000 to 9,999.000°F or units -1,128.000 to 5,537.000°C	- - - -	5924 [offset 40]	0x80 (128) 1 to 16 8	- - - -	28008	float R
<i>o.v</i> o.v	<i>Compare (1 to 16)</i> <b>Output Value</b> View the value of this function's output.	<i>oFF</i> Off (62) <i>oN</i> On (63)	- - - -	5928 [offset 40]	0x80 (128) 1 to 16 0xA (10)	- - - -	28010	uint R
No Display	<i>Compare (1 to 16)</i> <b>Error</b> Read reported cause for compare error	None (61) Open (65) Shorted (127) Measurement Error (140) Bad Cal Data (139) Ambient Error (9) RTD Error (141) Fail (32) Math Error (1423) Not Sourced (246) Stale (1617)	- - - -	5934 [offset 40]	0x80 (128) 1 to 16 0x0D (13)	- - - -	28013	uint R
<p>* These parameters/prompts are available in these menus with firmware revisions 6.0 and above. ** R: Read, W: Write, E: EEPROM, S: User Set</p>								

**RM Limit Module • Operations Page**

Display	Parameter Name Description	Range	Default	Modbus Relative Address	CIP Class Instance Attribute hex (dec)	Pro-fibus Index	Parameter ID	Data Type and Access **
<p><i>ETPr</i> <i>oPEr</i> <b>Timer Menu</b></p>								
<i>Su.A</i> Su.A	<i>Timer (1 to 16)</i> <b>Value Source A</b> View the value of Source A.	<i>oFF</i> Off (62) <i>oN</i> On (63)	----	7202 [offset 50]	0x83 (131) 1 to 16 7	----	31007	uint R
<i>Su.b</i> Su.b	<i>Timer (1 to 16)</i> <b>Value Source B</b> View the value of Source B.	<i>oFF</i> Off (62) <i>oN</i> On (63)	----	7204 [offset 50]	0x83 (131) 1 to 16 8	----	31008	uint R
<i>Et</i> E.t	<i>Timer (1 to 16)</i> <b>Elapsed Time</b> View the value of this function's elapsed time.	0 to 9,999.000 seconds	----	7220 [offset 50]	0x83 (131) 1 to 16 0x10 (16)	----	31016	float R
<i>o.v</i> o.v	<i>Timer (1 to 16)</i> <b>Output Value</b> View the value of this function's output.	<i>oFF</i> Off (62) <i>oN</i> On (63)	----	7208 [offset 50]	0x83 (131) 1 to 16 0x11 (17)	----	31010	uint R
No Display	<i>Timer (1 to 16)</i> <b>Running</b> Read to determine if timer is running	Off (62) On (63)	----	7218 [offset 50]	0x83 (131) 1 to 16 0x0F (15)	----	31015	uint R
No Display	<i>Timer (1 to 16)</i> <b>Error</b> Read reported cause for timer error	None (61) Open (65) Shorted (127) Measurement Error (140) Bad Cal Data (139) Ambient Error (9) RTD Error (141) Fail (32) Math Error (1423) Not Sourced (246) Stale (1617)	----	7224 [offset 50]	0x83 (131) 1 to 16 0x12 (18)	----	31018	uint R
<p>* These parameters/prompts are available in these menus with firmware revisions 6.0 and above. ** R: Read, W: Write, E: EEPROM, S: User Set</p>								

## RM Limit Module • Operations Page

Display	Parameter Name Description	Range	Default	Modbus Relative Address	CIP Class Instance Attribute hex (dec)	Pro-fibus Index	Parameter ID	Data Type and Access **
<b>CEr</b> <b>oPEr</b> <b>Counter Menu</b>								
<b>Ent</b> Cnt	<i>Counter (1 to 16)</i> <b>Count</b> View the function's total count.	0 to 9,999	- - - -	6578 [offset 40]	0x82 (130) 1 to 16 0xF (15)	217	30015	uint R
<b>SuA</b> Su.A	<i>Counter (1 to 16)</i> <b>Source Value A</b> View the value of Source A.	oFF Off (62) oN On (63)	- - - -	6562 [offset 40]	0x82 (130) 1 to 16 7	- - - -	30007	uint R
<b>SuB</b> Su.b	<i>Counter (1 to 16)</i> <b>Source Value B</b> View the value of Source B.	oFF Off (62) oN On (63)	- - - -	6564 [offset 40]	0x82 (130) 1 to 16 8	- - - -	30008	uint R
<b>oV</b> o.v	<i>Counter (1 to 16)</i> <b>Output Value</b> View the value of this function's output.	oFF Off (62) oN On (63)	- - - -	6568 [offset 40]	0x82 (130) 1 to 16 0xA (10)	- - - -	30010	uint R
No Display	<i>Counter (1 to 16)</i> <b>Error</b> Read reported cause for counter error	None (61) Open (65) Shorted (127) Measurement Error (140) Bad Cal Data (139) Ambient Error (9) RTD Error (141) Fail (32) Math Error (1423) Not Sourced (246) Stale (1617)	- - - -	6580 [offset 40]	0x82 (130) 1 to 16 0x10 (16)	- - - -	30016	uint R
<b>LGc</b> <b>oPEr</b> <b>Logic Menu</b>								
<b>SuA</b> Su.A	<i>Logic (1 to 16)</i> <b>Source Value A</b> View the value of Source A.	oFF Off (62) oN On (63)	- - - -	4678 [offset 80]	0x7F (127) 1 to 16 0x19 (25)	- - - -	27025	uint R
* These parameters/prompts are available in these menus with firmware revisions 6.0 and above. ** R: Read, W: Write, E: EEPROM, S: User Set								



**RM Limit Module • Operations Page**

Display	Parameter Name Description	Range	Default	Modbus Relative Address	CIP Class Instance Attribute hex (dec)	Pro-fibus Index	Parameter ID	Data Type and Access **
<b>Su.b</b> Su.b	<i>Logic (1 to 16)</i> <b>Source Value B</b> View the value of Source B.	<input type="checkbox"/> FF Off (62) <input type="checkbox"/> n On (63)	- - - -	4680 [offset 80]	0x7F (127) 1 to 16 0x1A (26)	- - - -	27026	uint R
<b>Su.C</b> Su.C	<i>Logic (1 to 16)</i> <b>Source Value C</b> View the value of Source C.	<input type="checkbox"/> FF Off (62) <input type="checkbox"/> n On (63)	- - - -	4682 [offset 80]	0x7F (127) 1 to 16 0x1B (27)	- - - -	27027	uint R
<b>Su.d</b> Su.d	<i>Logic (1 to 16)</i> <b>Source Value D</b> View the value of Source D.	<input type="checkbox"/> FF Off (62) <input type="checkbox"/> n On (63)	- - - -	4684 [offset 80]	0x7F (127) 1 to 16 0x1C (28)	- - - -	27028	uint R
<b>Su.E</b> Su.E	<i>Logic (1 to 16)</i> <b>Source Value E</b> View the value of Source E.	<input type="checkbox"/> FF Off (62) <input type="checkbox"/> n On (63)	- - - -	4686 [offset 80]	0x7F (127) 1 to 16 0x1D (29)	- - - -	27029	uint R
<b>Su.F</b> Su.F	<i>Logic (1 to 16)</i> <b>Source Value F</b> View the value of Source F.	<input type="checkbox"/> FF Off (62) <input type="checkbox"/> n On (63)	- - - -	4688 [offset 80]	0x7F (127) 1 to 16 0x1E (30)	- - - -	27030	uint R
<b>Su.g</b> Su.g	<i>Logic (1 to 16)</i> <b>Value Source G</b> View the value of Source G.	<input type="checkbox"/> FF Off (62) <input type="checkbox"/> n On (63)	- - - -	4690 [offset 80]	0x7F (127) 1 to 16 0x1F (31)	- - - -	27031	uint R
<b>Su.h</b> Su.h	<i>Logic (1 to 16)</i> <b>Source Value H</b> View the value of Source H.	<input type="checkbox"/> FF Off (62) <input type="checkbox"/> n On (63)	- - - -	4692 [offset 80]	0x7F (127) 1 to 16 0x20 (32)	- - - -	27032	uint R
<b>o.v</b> o.v	<i>Logic (1 to 16)</i> <b>Output Value</b> View the value of this function's output.	<input type="checkbox"/> FF Off (62) <input type="checkbox"/> n On (63)	- - - -	4696 [offset 80]	7F (127) 1 to 16 0x22 (34)	- - - -	27034	uint R

\* These parameters/prompts are available in these menus with firmware revisions 6.0 and above.

\*\* R: Read, W: Write, E: EEPROM, S: User Set

**RM Limit Module • Operations Page**

Display	Parameter Name Description	Range	Default	Modbus Relative Address	CIP Class Instance Attribute hex (dec)	Pro-fibus Index	Parameter ID	Data Type and Access **
No Display	<i>Logic (1 to 16)</i> <b>Error</b> Read reported cause for logic error	None (61) Open (65) Shorted (127) Measurement Error (140) Bad Cal Data (139) Ambient Error (9) RTD Error (141) Fail (32) Math Error (1423) Not Sourced (246) Stale (1617)	- - - -	4700 [offset 80]	0x7F (127) 1 to 16 0x24 (36)	- - - -	27036	uint R
<p><i>P7A</i> <i>oPEr</i> <b>Math Menu</b></p>								
<i>Su.A</i> Su.A	<i>Math (1 to 16)</i> <b>Source Value A</b> View the value of Source A.	-1,999.000 to 9,999.000°F or units -1,128.000 to 5,537.000°C	- - - -	3540 [offset 70]	0x7D (125) 1 to 16 0x10 (16)	- - - -	25016	float R
<i>Su.b</i> Su.b	<i>Math (1 to 16)</i> <b>Source Value B</b> View the value of Source B.	-1,999.000 to 9,999.000°F or units -1,128.000 to 5,537.000°C	- - - -	3542 [offset 70]	0x7D (125) 1 to 16 0x11 (17)	- - - -	25017	float R
<i>Su.C</i> Su.C	<i>Math (1 to 16)</i> <b>Source Value C</b> View the value of Source C.	-1,999.000 to 9,999.000°F or units -1,128.000 to 5,537.000°C	- - - -	3544 [offset 70]	0x7D (125) 1 to 16 0x12 (18)	- - - -	25018	float R
<i>Su.d</i> Su.d	<i>Math (1 to 16)</i> <b>Source Value D</b> View the value of Source D.	-1,999.000 to 9,999.000°F or units -1,128.000 to 5,537.000°C	- - - -	3546 [offset 70]	0x7D (125) 1 to 16 0x13 (19)	- - - -	25019	float R
<i>Su.E</i> Su.E	<i>Math (1 to 16)</i> <b>Source Value E</b> View the value of Source E.	<i>oFF</i> Off (62) <i>oN</i> On (63)	- - - -	3548 [offset 70]	0x7D (125) 1 to 16 0x14 (20)	- - - -	25020	uint R
<i>oFSt</i> oFSt	<i>Math (1 to 16)</i> <b>Offset</b> Set an offset to be applied to this function's output.	-1,999.000 to 9,999.000°F or units -1,128.000 to 5,537.000°C	0	3554 [offset 70]	0x7D (125) 1 to 16 0x17 (23)	- - - -	25023	float RWES

\* These parameters/prompts are available in these menus with firmware revisions 6.0 and above.

\*\* R: Read, W: Write, E: EEPROM, S: User Set

**RM Limit Module • Operations Page**

Display	Parameter Name Description	Range	Default	Modbus Relative Address	CIP Class Instance Attribute hex (dec)	Pro-fibus Index	Parameter ID	Data Type and Access **
<b>o.v</b> o.v	<i>Math (1 to 16)</i> <b>Output Value</b> View the value of this function's output.	-1,999.000 to 9,999.000° F or units -1,128.000 to 5,537.000° C	- - - -	3552 [offset 70]	0x7D (125) 1 to 16 0x16 (22)	- - - -	25022	float R
No Display	<i>Math (1 to 16)</i> <b>Error</b> Read reported cause for logic error	None (61) Open (65) Shorted (127) Measurement Error (140) Bad Cal Data (139) Ambient Error (9) RTD Error (141) Fail (32) Math Error (1423) Not Sourced (246) Stale (1617)	- - - -	3566 [offset 70]	0x7D (125) 1 to 16 0x1D (29)	- - - -	25029	uint R

\* These parameters/prompts are available in these menus with firmware revisions 6.0 and above.  
 \*\* R: Read, W: Write, E: EEPROM, S: User Set

# 4

## Chapter 4: Setup Pages

### RML Module Setup Page Parameters

To navigate to the Setup Page using the RUI, follow the steps below:

1. From the Home Page, press and hold both the Up ▲ and Down ▼ keys for six seconds. *A I* will appear in the upper display and *SEt* will appear in the lower display.

#### Note:

If keys are released when *oPEr* is displayed, press the Infinity Key ∞ or reset key to exit and repeat until *SEt* is displayed.

2. Press the Up ▲ or Down ▼ key to view available menus.
3. Press the Advance Key ⏩ to enter the menu of choice.
4. If a submenu exists (more than one instance), press the Up ▲ or Down ▼ key to select and then press the Advance Key ⏩ to enter.
5. Press the Up ▲ or Down ▼ key to move through available menu prompts.
6. Press the Infinity Key ∞ to move backwards through the levels: parameter to submenu, submenu to menu, menu to Home Page.
7. Press and hold the Infinity Key ∞ for two seconds to return to the Home Page.

On the following pages, top level menus are identified with a yellow background color.

#### Note:

Some of these menus and parameters may not appear, depending on the controller's options. See model number information in the Appendix for more information. If there is only one instance of a menu, no submenus will appear.

#### Note:

Some of the listed parameters may not be visible. Parameter visibility is dependent upon controller part number.

#### Note:

Some values will be rounded off to fit in the four-character RUI display. Full values can be read with other interfaces. In firmware 9.0 and above, a user may specify ranges greater than may be displayed by an RUI. If greater or less than an RUI can display, the display will show Value High *uALH* or Value Low *uALL*.

<i>A I</i>	<i>rLo</i> Range Low	<i>CoB</i> Custom Coefficient B
<i>SEt</i> Analog Input Menu	<i>rHi</i> Range High	<i>CoC</i> Custom Coefficient C
<i>I</i>	<i>PEE</i> Process Error Enable	<i>FiL</i> Filter
<i>A I</i> Analog Input (1 to 12)	<i>PEL</i> Process Error Low Value	<i>iEr</i> Input Error Latching
<i>SEn</i> Sensor Type	<i>tC</i> Thermistor Curve	<i>dEC</i> Display Precision
<i>Lin</i> TC Linearization	<i>rR</i> Resistance Range	<i>CoA</i> Calibration Offset
<i>Unit</i> Units	<i>CoA</i> Custom Coefficient A	<i>AIn</i> Analog Input Value*
<i>SLo</i> Scale Low		<i>iEr</i> Input Error
<i>SHi</i> Scale High		

*d io*  
**SEE Digital Input/Output Menu**  
*I*  
*d io* Digital Input/Output (1 to 6 and 9)  
*d ir* Direction  
*F n* Function  
*F i* Output Function Instance  
*SZ A* Output Source Zone  
*a ct* Time Base Type  
*a tb* Fixed Time Base  
*a lo* Low Power Scale  
*a h i* High Power Scale

**ACT**  
**SEE Action Menu**  
*I*  
*ACT* Action (1 to 16)  
*F n* Action Function  
*F i* Function Instance  
*SFnA* Source Function A  
*S iA* Source Instance A  
*SZ A* Source Zone A  
*LE u* Active Level

**L i m i t**  
**SEE Limit Menu**  
*I*  
*L i m i t* Limit (1 to 12)  
*L S d* Sides  
*L h y* Hysteresis  
*S P L h* Maximum Set Point  
*S P L L* Minimum Set Point  
*L h S* High Limit Set Point\*  
*L L S* Low Limit Set Point\*  
*S F n A* Source Function A\*  
*S i A* Source Instance A\*  
*S Z A* Source Zone A\*  
*L C r* Clear Limit\*  
*L S t* Limit Status\*

**o u t P u t**  
**SEE Output Menu**  
*I*  
*o u t P u t* Output (1 to 10, 7 to 10)  
*F n* Function Instance  
*F i* Output Function Instance

*S Z* Output Source Zone  
*a ct* Time Base Type  
*a t P* Fixed Time Base  
*a lo* Low Power Scale  
*a h i* High Power Scale

**ALARM**  
**SEE Alarm Menu**  
*I*  
*ALARM* Alarm (1 to 16)  
*A t y* Type  
*S r A* Alarm Source  
*i S A* Alarm Source Instance  
*S Z A* Alarm Source Zone  
*A h y* Hysteresis  
*ALG* Logic  
*AS d* Sides  
*AL o* Low Set Point\*  
*A h i* High Set Point\*  
*ALA* Latching  
*AbL* Blocking  
*AS i* Silencing  
*AdSP* Display  
*AdL* Delay Time  
*ACL r* Clear Alarm\*  
*AS i r* Silence Alarm\*  
*AS t* Alarm State\*

**L i n e a r i z a t i o n**  
**SEE Linearization Menu**  
*I*  
*L i n e a r i z a t i o n* Linearization 1 to 16  
*F n* Function  
*S F n A* Source Function A  
*S i A* Source Instance A  
*S Z A* Source Zone A  
*U n i t* Units  
*i P. 1* Input Point 1  
*o P. 1* Output Point 1  
*i P. 2* Input Point 2  
*o P. 2* Output Point 2  
*i P. 3* Input Point 3  
*o P. 3* Output Point 3  
*i P. 4* Input Point 4  
*o P. 4* Output Point 4  
*i P. 5* Input Point 5  
*o P. 5* Output Point 5  
*i P. 6* Input Point 6  
*o P. 6* Output Point 6

*i P. 7* Input Point 7  
*o P. 7* Output Point 7  
*i P. 8* Input Point 8  
*o P. 8* Output Point 8  
*i P. 9* Input Point 9  
*o P. 9* Output Point 9  
*i P. 10* Input Point 10  
*o P. 10* Output Point 10

**C P E**  
**SEE Compare Menu**  
*I*  
*C P E* Compare (1 to 16)  
*F n* Function  
*t o L* Tolerance  
*S F n A* Source Function A  
*S i A* Source Instance A  
*S Z A* Source Zone A  
*S F n B* Source Function B  
*S i B* Source Instance B  
*S Z B* Source Zone B  
*E r h* Error Handling

**t i m e r**  
**SEE Timer Menu**  
*I*  
*t i m e r* Timer (1 to 16)  
*F n* Function  
*S F n A* Source Function A  
*S i A* Source Instance A  
*S Z A* Source Zone A  
*S A S A* Run Active Level  
*S F n B* Source Function B  
*S i B* Source Instance B  
*S Z B* Source Zone B  
*S A S B* Reset Active Level  
*t i* Time  
*LE u* Transmitter Active Level

**C o u n t e r**  
**SEE Counter Menu**  
*I*  
*C o u n t e r* Counter (1 to 16)  
*F n* Function  
*S F n A* Source Function A  
*S i A* Source Instance A  
*S Z A* Source Zone A  
*S A S A* Count Active Level  
*S F n B* Source Function B  
*S i B* Source Instance B

*S2b* Source Zone B  
*SASb* Reset Active Level  
*LoAd* Load Value  
*Trgt* Target Value  
*LAt* Latching

## *L9C*

### *SEt* Logic Menu

*!*

#### *L9C* Logic (1 to 16)

*Fn* Function  
*SFnA* Source Function A  
*SiA* Source Instance A  
*SZA* Source Zone A  
*SFnB* Source Function B  
*SiB* Source Instance B  
*S2b* Source Zone B  
*SFnC* Source Function C  
*SiC* Source Instance C  
*S2C* Source Zone C  
*SFnD* Source Function D  
*SiD* Source Instance D  
*S2d* Source Zone D  
*SFnE* Source Function E  
*SiE* Source Instance E  
*S2E* Source Zone E  
*SFnF* Source Function F  
*SiF* Source Instance F  
*S2F* Source Zone F  
*SFnG* Source Function G  
*SiG* Source Instance G  
*S2g* Source Zone G  
*SFnH* Source Function H  
*SiH* Source Instance H  
*S2H* Source Zone H  
*Errh* Error Handling

## *P7At*

### *SEt* Math Menu

*!*

#### *P7At* Math (1 to 16)

*Fn* Function  
*SFnA* Source Function A  
*SiA* Source Instance A  
*SZA* Source Zone A  
*SFnB* Source Function B  
*SiB* Source Instance B  
*S2b* Source Zone B  
*SFnC* Source Function C  
*SiC* Source Instance C

*S2C* Source Zone C  
*SFnD* Source Function D  
*SiD* Source Instance D  
*S2d* Source Zone D  
*SFnE* Source Function E  
*SiE* Source Instance E  
*S2E* Source Zone E  
*SLo* Scale Low  
*Shi* Scale High  
*Units* Units  
*rLo* Range Low  
*rHi* Range High  
*PUnit* Pressure Units  
*AltUnit* Altitude Units  
*FiL* Filter

## *uAr*

### *SEt* Variable Menu

*!*

#### *uAr* Variable (1 to 16)

*tYPE* Data Type  
*Unit* Units  
*dig* Digital  
*AnLG* Analog

## *9LbL*

### *SEt* Global Menu

*9LbL* Global  
*C\_F* Display Units  
*ACLF* AC Line Frequency  
*P7AH* Maximum  
*P7in* Minimum  
*dPrS* Display Pairs  
*USrS* Save Settings As  
*USrR* Restore Settings From

## *CO77*

### *SEt* Communications Menu

*CO77* Communications  
*bAUd* Baud Rate  
*PAR* Parity  
*P7hL* Modbus Word Order  
*C\_F* Display Units  
*nuS* Non-volatile Save

**RM Limit Module • Setup Page**

Display	Parameter Name Description	Range	Default	Modbus Relative Address	CIP - Class Instance Attribute hex (dec)	Pro-fibus Index	Parameter ID	Data Type and Access **
<b>A ,</b> <b>SEt</b> <b>Analog Input Menu</b>								
<b>SEn</b> SEn	<b>Analog Input (1 to 12)</b> <b>Sensor Type</b> Set the analog sensor type to match the device wired to this input.  <b>Note:</b> There is no open sensor protection for process inputs.	<b>oFF</b> Off (62) <b>tC</b> Thermocouple (95) <b>mV</b> Millivolts (56) <b>volt</b> Volts dc (104) <b>mA</b> Milliamps dc (112) <b>100 Ω</b> RTD 100 Ω (113) <b>1000 Ω</b> RTD 1,000 Ω (114) <b>Pot</b> Potentiometer 1 kΩ (155) <b>ther</b> Thermistor (229)	Thermo-couple or Thermistor	418 [offset 90]	0x68 (104) 1 to 12 5	3	4005	uint RWES
<b>Lin</b> Lin	<b>Analog Input (1 to 12)</b> <b>TC Linearization</b> Set the linearization to match the thermocouple wired to this input.	<b>b</b> B (11) <b>H</b> K (48) <b>C</b> C (15) <b>N</b> N (58) <b>d</b> D (23) <b>R</b> R (80) <b>E</b> E (26) <b>S</b> S (84) <b>F</b> F (30) <b>t</b> T (93) <b>J</b> J (46)	J	420 [offset 90]	0x68 (104) 1 to 12 6	4	4006	uint RWES
<b>Unit</b> Unit	<b>Analog Input (1 to 12)</b> <b>Units</b> Set the type of units the sensor will measure.	<b>ATP</b> Absolute Temperature (1540) <b>rh</b> Relative Humidity (1538) <b>Pro</b> Process (75) <b>Power</b> Power (73)	Process	492 [offset 90]	0x68 (104) 1 to 12 0x2A (42)	5	4042	uint RWES
<b>SLo</b> S.Lo	<b>Analog Input (1 to 12)</b> <b>Scale Low</b> Set the low scale for process inputs. This value, in millivolts, volts or milliamps, will correspond to the Range Low output of this function block.	-100.0 to 1,000.0	0.0	438 [offset 90]	0x68 (104) 1 to 12 0xF (15)	6	4015	float RWES

\* These parameters/prompts are available in these menus with firmware revisions 6.0 and above.

\*\* R: Read, W: Write, E: EEPROM, S: User Set

**RM Limit Module • Setup Page**

Display	Parameter Name Description	Range	Default	Modbus Relative Address	CIP - Class Instance Attribute hex (dec)	Pro-fibus Index	Parameter ID	Data Type and Access **
<b>S.h</b> S.hi	<i>Analog Input (1 to 12)</i> <b>Scale High</b> Set the high scale for process inputs. This value, in millivolts, volts or milliamperes, will correspond to the Range High output of this function block.	-100.0 to 1,000.0	20.0	440 [offset 90]	0x68 (104) 1 to 12 0x10 (16)	7	4016	float RWES
<b>r.Lo</b> r.Lo	<i>Analog Input (1 to 12)</i> <b>Range Low</b> Set the low range for this function block's output.	-1,128.000 to 5,537.000 °C	0.0F -18C	442 [offset 90]	0x68 (104) 1 to 12 0x11 (17)	8	4017	float RWES
<b>r.h</b> r.hi	<i>Analog Input (1 to 12)</i> <b>Range High</b> Set the high range for this function block's output.	-1,128.000 to 5,537.000 °C	9,999.0 F 5537.0 C	444 [offset 90]	0x68 (104) 1 to 12 0x12 (18)	9	4018	float RWES
<b>P.EE</b> P.EE	<i>Analog Input (1 to 12)</i> <b>Process Error Enable</b> Turn the Process Error Low feature on or off.	<b>OFF</b> Off (62) <b>LOLW</b> Low (53)	Off	468 [offset 90]	0x68 (104) 1 to 12 0x1E (30)	10	4030	uint RWES
<b>P.EL</b> P.EL	<i>Analog Input (1 to 12)</i> <b>Process Error Low Value</b> If the process value drops below this value, it will trigger an input error.	-100.0 to 1,000.0	0.0	470 [offset 90]	0x68 (104) 1 to 12 0x1F (31)	11	4031	float RWES
<b>t.C</b> t.C	<i>Analog Input (1 to 12)</i> <b>Thermistor Curve</b> Select a curve to apply to the thermistor input.	<b>A</b> Curve A (1451) <b>b</b> Curve B (1452) <b>C</b> Curve C (1453) <b>CUSt</b> Custom (180)	Curve A	484 [offset 90]	0x68 (104) 1 to 12 0x26 (38)	- - - -	4038	uint RWES

\* These parameters/prompts are available in these menus with firmware revisions 6.0 and above.

\*\* R: Read, W: Write, E: EEPROM, S: User Set



**RM Limit Module • Setup Page**

Display	Parameter Name Description	Range	Default	Modbus Relative Address	CIP - Class Instance Attribute hex (dec)	Pro-fibus Index	Parameter ID	Data Type and Access **
r.r r.r	<i>Analog Input (1 to 12)</i> <b>Resistance Range</b> Set the maximum resistance of the thermistor input.	5 5K (1448) 10 10K (1360) 20 20K (1361) 40 40K (1449)	40K	432 [offset 90]	0x68 (104) 1 to 12 0x25 (37)	- - - -	4037	uint RWES
[Co.A Co.A	<i>Analog Input (1 to 12)</i> <b>Custom Coefficient A</b> Enter custom Thermistor coefficients.	-3.4e38 to 3.4e38	0	- - - -	- - - -	- - - -	4039	float RWES
[Co.b Co.b	<i>Analog Input (1 to 12)</i> <b>Custom Coefficient B</b> Enter custom Thermistor coefficients.	-3.4e38 to 3.4e38	0	- - - -	- - - -	- - - -	4040	float RWES
[Co.C Co.C	<i>Analog Input (1 to 12)</i> <b>Custom Coefficient C</b> Enter custom Thermistor coefficients.	-3.4e38 to 3.4e38	0	- - - -	- - - -	- - - -	4041	float RWES
F iL FiL	<i>Analog Input (1 to 12)</i> <b>Filter</b> Filtering smooths out the process signal to both the display and the input. Increase the time to increase filtering.  <b>Note:</b> Filter does not apply to the Limit sensor but does apply to all other functions.	0.0 to 60.0 seconds	0.5	386 [offset 90]	0x68 (104) 1 to 12 0xE (14)	12	4014	float RWES

\* These parameters/prompts are available in these menus with firmware revisions 6.0 and above.

\*\* R: Read, W: Write, E: EEPROM, S: User Set

**RM Limit Module • Setup Page**

Display	Parameter Name Description	Range	Default	Modbus Relative Address	CIP - Class Instance Attribute hex (dec)	Pro- fibus Index	Param- eter ID	Data Type and Access **
<b>i.Er</b> i.Er	<i>Analog Input (1 to 12)</i> <b>Error Latching</b> Turn input error latching on or off. If latching is on, errors must be manually cleared.	<b>oFF</b> Off (62) <b>oN</b> On (63)	Off	414 [offset 90]	0x68 (104) 1 to 12 0x1C (28)	- - - -	4028	uint RWES
<b>dEC</b> dEC	<i>Analog Input (1 to 12)</i> <b>Display Precision</b> Set the precision of the displayed value.	<b>0</b> Whole (105) <b>00</b> Tenths (94) <b>000</b> Hundredths (40) <b>0000</b> Thousandths (96)	Whole	398 [offset 90]	0x68 (104) 1 to 12 0x14 (20)	- - - -	4020	uint RWES
<b>i.CA</b> i.CA	<i>Analog Input (1 to 12)</i> <b>Calibration Offset *</b> Offset the input reading to compensate for lead wire resistance or other factors that cause the input reading to vary from the actual process value.	-1,999.000 to 9,999.000 °F or units -1,110.555 to 5,555.000 °C	0.0	432 [offset 90]	0x68 (104) 1 to 12 0xC (12)	- - - -	4012	float RWES
<b>Ain</b> Ain	<i>Analog Input (1 to 12)</i> <b>Value *</b> View the process value. Note: Ensure that the Error Status (below) indicates no error (61) when reading this value using a field bus protocol. If an error exists, the last known value prior to the error occurring will be returned.	-1,999.000 to 9,999.000 °F or units -1,128.000 to 5,537.000 °C	- - - -	410 [offset 90]	0x68 (104) 1 to 12 1	0	4001	float R

\* These parameters/prompts are available in these menus with firmware revisions 6.0 and above.

\*\* R: Read, W: Write, E: EEPROM, S: User Set

**RM Limit Module • Setup Page**

Display	Parameter Name Description	Range	Default	Modbus Relative Address	CIP - Class Instance Attribute hex (dec)	Pro-fibus Index	Parameter ID	Data Type and Access **
i.Er	<b>Analog Input (1 to 12) Input Error *</b> View the cause of the most recent error.	None (61) Open (65) Shorted (127) Measurement Error (140) Bad Calibration Data (139) Ambient Error (9) RTD Error (141) Fail (32)	----	412 [offset 90]	0x68 (104) 1 to 12 2	1	4002	uint R
<p><b>SET</b></p> <p><b>Digital Input/Output Menu</b></p>								
dir	<b>Digital Input/Output (1 to 6) Direction</b> Set this function to operate as an input or output.	Output (68) Input Voltage (193) Input Dry Contact (44)	Output	1850 [offset 30]	0x6A (106) 1 to 6 1	82	6001	uint RWES
dir	<b>Digital Input (9) Direction</b> Set the input type.	Input Voltage (193) Input Dry Contact (44)	Dry Contact	2090 [offset 30]	0x6A (106) 9 1	82	6001	uint RWES
Fn	<b>Digital Output (1 to 6) Function</b> Select what function will drive this output.	Off (62) Alarm (6) Compare (230) Counter (231) Digital I/O (1142) Function Key (1001) Linearization (238) Logic (239) Math (240) Timer (244) Variable (245) Heater Error (184)	Off	1858 [offset 30]	0x6A (106) 1 to 6 5	83	6005	uint RWES
Fi	<b>Digital Output (1 to 6) Output Function Instance</b> Set the instance of the function selected above.	1 to 250	1	1860 [offset 30]	0x6A (106) 1 to 6 6	84	6006	uint RWES

\* These parameters/prompts are available in these menus with firmware revisions 6.0 and above.

\*\* R: Read, W: Write, E: EEPROM, S: User Set

**RM Limit Module • Setup Page**

Display	Parameter Name Description	Range	Default	Modbus Relative Address	CIP - Class Instance Attribute hex (dec)	Pro-fibus Index	Parameter ID	Data Type and Access **
<b>SZ.A</b> SZ.A	<i>Digital Output (1 to 6)</i> <b>Output Source Zone</b> Set the zone of the function selected above.		0	1872 [offset 30]	0x6A (106) 1 to 6 0xC (12)	- - - -	6012	uint RWES
<b>o.Ct</b> o.Ct	<i>Digital Output (1 to 6)</i> <b>Time Base Type</b> Set the output control type. This parameter is only used with PID control, but can be set anytime.	<b>Ftb</b> Fixed Time Base (34) <b>vtb</b> Variable Time Base (103)	Fixed Time Base	1852 [offset 30]	0x6A (106) 1 to 6 2	85	6002	uint RWES
<b>o.tb</b> o.tb	<i>Digital Output (1 to 6)</i> <b>Fixed Time Base</b> Set the time base for fixed-time-base control.	0.1 to 60.0 seconds	1.0	1854 [offset 30]	0x6A (106) 1 to 6 3	86	6003	float RWES
<b>o.Lo</b> o.Lo	<i>Digital Output (1 to 6)</i> <b>Low Power Scale</b> The power output will never be less than the value specified and will represent the value at which output scaling begins.	0.0 to 100.0	0.0	1866 [offset 30]	0x6A (106) 1 to 6 9	87	6009	float RWES
<b>o.hi</b> o.hi	<i>Digital Output (1 to 6)</i> <b>High Power Scale</b> The power output will never be greater than the value specified and will represent the value at which output scaling stops.	0.0 to 100.0	100.0	1868 [offset 30]	0x6A (106) 1 to 6 A (10)	88	6010	float RWES

\* These parameters/prompts are available in these menus with firmware revisions 6.0 and above.

\*\* R: Read, W: Write, E: EEPROM, S: User Set

**RM Limit Module • Setup Page**

Display	Parameter Name Description	Range	Default	Modbus Relative Address	CIP - Class Instance Attribute hex (dec)	Pro-fibus Index	Param-eter ID	Data Type and Access **
<p><i>ACT</i> <i>SET</i> <b>Action Menu</b></p>								
<i>Fn</i> Fn	<i>Action (1 to 16)</i> <b>Action Function</b> Set the action that will be triggered by this function.	<i>nonE</i> None (61) <i>USRr</i> User Set Restore (227) <i>ALPn</i> Alarm (6) <i>SIL</i> Silence Alarms (108) <i>RoF</i> Control Loops Off and Alarms to Non-alarm State (220) <i>FAL</i> Force Alarm to Occur (218)	None	2214 [offset 20]	0x6E (110) 1 to 16 3	138	10003	uint RWES
<i>Fi</i> Fi	<i>Action (1 to 16)</i> <b>Function Instance</b> Set the instance of the function selected above.	0 to 25	0	2216 [offset 20]	0x6E (110) 1 to 16 4	139	10004	uint RWES
<i>SFn.A</i> SFn.A	<i>Action (1 to 16)</i> <b>Source Function A</b> Set the event or function that will trigger the action.	<i>nonE</i> None (61) <i>ALPn</i> Alarm (6) <i>CPE</i> Compare (230) <i>Ctr</i> Counter (231) <i>dio</i> Digital I/O (1142) <i>Ent.A</i> Profile Event Out A (233) <i>Ent.B</i> Profile Event Out B (234) <i>Ent.C</i> Profile Event Out C (235) <i>Ent.D</i> Profile Event Out D (236) <i>Ent.E</i> Profile Event Out E (247) <i>Ent.F</i> Profile Event Out F (248) <i>Ent.G</i> Profile Event Out G (249) <i>Ent.H</i> Profile Event Out H (250) <i>FUn</i> Function Key (1001) <i>L.Pn</i> Limit (126) <i>LGC</i> Logic (239) <i>TPTr</i> Timer (244) <i>vAr</i> Variable (245) <i>HEr</i> Heater Error (184)	None	2220 [offset 20]	0x6E (110) 1 to 16 6	- - - -	10006	uint RWES

\* These parameters/prompts are available in these menus with firmware revisions 6.0 and above.  
\*\* R: Read, W: Write, E: EEPROM, S: User Set

**RM Limit Module • Setup Page**

Display	Parameter Name Description	Range	Default	Modbus Relative Address	CIP - Class Instance Attribute hex (dec)	Pro-fibus Index	Parameter ID	Data Type and Access **
<b>5.iA</b> Si.A	<i>Action (1 to 16)</i> <b>Source Instance A</b> Set the instance of the function selected above.	1 to 250	1	2212 [offset 20]	0x6E (110) 1 to 16 2	- - - -	10002	uint RWES
<b>52.A</b> SZ.A	<i>Action (1 to 16)</i> <b>Source Zone A</b> Set the zone of the function selected above.	0 to 24	0	2222 [offset 20]	0x6E (110) 1 to 16 7	- - - -	10007	uint RWES
<b>LEu</b> LEV	<i>Action (1 to 16)</i> <b>Active Level</b> Set the action that will be considered a true state.	<b>Low (53)</b> <b>High (37)</b>	High	2230 [offset 20]	0x6E (110) 1 to 16 1	137	10001	uint RWES

**L.P7**  
**SEt**

**Limit Menu**

<b>L5d</b> L.Sd	<i>Limit (1 to 12)</i> <b>Sides</b> Select which side or sides of the process value will be monitored.	<b>both</b> Both (13) <b>h.i9h</b> High (37) <b>Low</b> Low (53)	Both	1498 [offset 30]	0x70 (112) 1 to 12 5	40	12005	uint RWES
<b>LhY</b> L.hy	<i>Limit (1 to 12)</i> <b>Hysteresis</b> Set the hysteresis for the limit function. This determines how far into the safe range the process value must move before the limit can be cleared.	0.001 to 9,999.000°F or units 0.001 to 5,555.000°C	3.0°F or units 2.0°C	1492 [offset 30]	0x70 (112) 1 to 12 2	41	12002	float RWES
<b>SP.Lh</b> SP.Lh	<i>Limit (1 to 12)</i> <b>Maximum Set Point</b> Set the high end of the limit set point range.	-1,999.000 to 9,999.000	9,999.000	1506 [offset 30]	0x70 (112) 1 to 12 9	39	12009	float RWES

\* These parameters/prompts are available in these menus with firmware revisions 6.0 and above.

\*\* R: Read, W: Write, E: EEPROM, S: User Set

**RM Limit Module • Setup Page**

Display	Parameter Name Description	Range	Default	Modbus Relative Address	CIP - Class Instance Attribute hex (dec)	Pro-fibus Index	Parameter ID	Data Type and Access **
<i>SP.LL</i> SP.LL	<i>Limit (1 to 12) Minimum Set Point</i> Set the low end of the limit set point range.	-1,999.000 to 9,999.000	-1,999.000	1508 [offset 30]	0x70 (112) 1 to 12 0xA (10)	38	12010	float RWES
<i>Lh.S</i> Lh.S	<i>Limit (1 to 12) High Limit Set Point *</i> Set the high process value that will trigger the limit.	-1,999.000 to 9,999.000 °F or units -1,128.000 to 5,537.000 °C	0.0 °F or units -18.0 °C	1496 [offset 30]	0x70 (112) 1 to 12 4	42	12004	float RWES
<i>LL.S</i> LL.S	<i>Limit (1 to 12) Low Limit Set Point *</i> Set the low process value that will trigger the limit.	-1,999.000 to 9,999.000 °F or units -1,128.000 to 5,537.000 °C	0.0 °F or units -18.0 °C	1494 [offset 30]	0x70 (112) 1 to 12 3	43	12003	float RWES
<i>SFn.A</i> SFn.A	<i>Limit (1 to 12) Source Function A *</i> Set the source for the limit reset function.	<i>none</i> None (61) <i>dio</i> Digital I/O (1142) <i>FUn</i> Function Key (1001) <i>uAr</i> Variable (245)	None	748 [offset 30]	0x70 (112) 1 to 12 0x0F (15)	- - - -	12015	uint RWES
<i>Si.A</i> Si.A	<i>Limit (1 to 12) Source Instance A *</i> Set the instance of the function selected above.	1 to 250	1	- - - -	0x70 (112) 1 to 12 0x10 (16)	- - - -	12016	uint RWES
<i>SZ.A</i> SZ.A	<i>Limit (1 to 12) Source Zone A *</i> Set the zone of the function selected above.	0 to 24	0	- - - -	0x70 (112) 1 to 12 0x11 (17)	- - - -	12017	uint RWES
<i>LCr</i> LCr	<i>Limit (1 to 12) Clear Limit *</i> Clear limit once limit condition is safe.	<i>ELr</i> Clear (0) <i>Ignr</i> Ignore (204)	Ignore	720 [offset 30]	0x70 (112) 1 to 12 1	- - - -	12014	uint W

\* These parameters/prompts are available in these menus with firmware revisions 6.0 and above.

\*\* R: Read, W: Write, E: EEPROM, S: User Set

**RM Limit Module • Setup Page**

Display	Parameter Name Description	Range	Default	Modbus Relative Address	CIP - Class Instance Attribute hex (dec)	Pro-fibus Index	Parameter ID	Data Type and Access **
<i>LSt</i> L.St	<i>Limit (1 to 12)</i> <b>Limit Status *</b> Reflects whether or not the limit is in a safe or failed mode.	<i>FAIL</i> Fail (32) <i>SAFE</i> Safe (1667)	----	744 [offset 30]	0x70 (112) 1 to 12 0x0D (13)	----	12013	uint R

*oPt*  
*SEt*

**Output Menu**

<i>Fn</i> Fn	<i>Output Digital (1 to 4 and 7 to 10)</i> <b>Function</b> Select what function will drive this output.  <b>Note:</b> Output 8 is set by default (factory settings) to module limit.	<i>oFF</i> Off (62) <i>Ai</i> Analog Input (142) <i>ALPn</i> Alarm (6) <i>CPr</i> Cool Power (161) <i>hPr</i> Heat Power (160) <i>CPE</i> Compare (230) <i>Ctr</i> Counter (231) <i>diO</i> Digital I/O (1142) <i>Ent.A</i> Profile Event Out A (233) <i>Ent.B</i> Profile Event Out B (234) <i>Ent.C</i> Profile Event Out C (235) <i>Ent.D</i> Profile Event Out D (236) <i>Ent.E</i> Profile Event Out E (247) <i>Ent.F</i> Profile Event Out F (248) <i>Ent.G</i> Profile Event Out G (249) <i>Ent.H</i> Profile Event Out H (250) <i>FUn</i> Function Key (1001) <i>LGc</i> Logic (239) <i>Lnr</i> Linearization (238) <i>MAE</i> Math (240) <i>Pv</i> Process Value (241) <i>SoF.1</i> Special Function Output 1 (1532) <i>SoF.2</i> Special Function Output 2 (1533) <i>SoF.3</i> Special Function Output 3 (1534) <i>SoF.4</i> Special Function Output 4 (1535) <i>TPTr</i> Timer (244) <i>vAr</i> Variable (245) <i>PLi</i> Limit (126) <i>LIPn</i> Limit (126)	off	1858 [offset 30]	0x6A (106) 1 to 10 5	96	6005	uint RWES
-----------------	---	--	-----	---------------------	-------------------------------	----	------	--------------

\* These parameters/prompts are available in these menus with firmware revisions 6.0 and above.

\*\* R: Read, W: Write, E: EEPROM, S: User Set



**RM Limit Module • Setup Page**

Display	Parameter Name Description	Range	Default	Modbus Relative Address	CIP - Class Instance Attribute hex (dec)	Pro-fibus Index	Parameter ID	Data Type and Access **
<b>F</b> , Fi	<i>Output Digital (1 to 4 and 7 to 10)</i> <b>Output Function Instance</b> Set the instance of the function selected above.	1 to 250	1	1860 [offset 30]	0x6A (106) 1 to 106	- - - -	6006	uint RWES
<b>SZ.A</b> SZ.A	<i>Output Digital (1 to 4 and 7 to 10)</i> <b>Output Source Zone</b> Set the instance of the function selected above.	0 to 24	0	1872 [offset 30]	0x6A (106) 1 to 10 0xC (12)	- - - -	6012	uint RWES
<b>o.Ct</b> o.Ct	<i>Output Digital (1 to 4 and 7 to 10)</i> <b>Time Base Type</b> Set the output control type. This parameter is only used with PID control, but can be set anytime.	<b>Ft b</b> Fixed Time Base (34) <b>vt b</b> Variable Time Base (103)	Fixed Time Base	1852 [offset 30]	0x6A (106) 1 to 102	- - - -	6002	uint RWES
<b>o.tb</b> o.tb	<i>Output Digital (1 to 4 and 7 to 10)</i> <b>Fixed Time Base</b> Set the time base for fixed-time-base control.	0.1 to 60.0 seconds (solid-state relay or switched dc) 5.0 to 60.0 seconds (mechanical relay or NO-ARC power control)	1.0 sec. [SSR & sw dc] 20.0 sec. [mech, relay, NO-ARC]	1854 [offset 30]	0x6A (106) 1 to 103	- - - -	6003	float RWES
<b>o.Lo</b> o.Lo	<i>Output Digital (1 to 4 and 7 to 10)</i> <b>Low Power Scale</b> The power output will never be less than the value specified and will represent the value at which output scaling begins.	0.0 to 100.0%	0.0%	1866 [offset 30]	0x6A (106) 1 to 109	- - - -	6009	float RWES

\* These parameters/prompts are available in these menus with firmware revisions 6.0 and above.

\*\* R: Read, W: Write, E: EEPROM, S: User Set

**RM Limit Module • Setup Page**

Display	Parameter Name Description	Range	Default	Modbus Relative Address	CIP - Class Instance Attribute hex (dec)	Pro-fibus Index	Parameter ID	Data Type and Access **
<i>o.hi</i> o.hi	<i>Output Digital (1 to 4 and 7 to 10)</i> <b>High Power Scale</b> The power output will never be greater than the value specified and will represent the value at which output scaling stops.	0.0 to 100.0%	100.0%	1868 [offset 30]	0x6A (106) 1 to 10 0xA (10)	- - - -	6010	float RWES
<p><i>ALPM</i> <i>SET</i> <b>Alarm Menu</b></p>								
<i>ALTY</i> A.ty	<i>Alarm (1 to 16)</i> <b>Type</b> Select whether the alarm trigger is a fixed value or will track the set point.	<i>OFF</i> Off (62) <i>Pr.AL</i> Process Alarm (76) <i>dE.AL</i> Deviation Alarm (24)	Off	2558 [offset 60]	0x6D (109) 1 to 16 0xF (15)	20	9015	uint RWES
<i>Sr.A</i> Sr.A	<i>Alarm (1 to 16)</i> <b>Alarm Source</b> Select what will trigger this alarm.	<i>none</i> None (61) <i>Ai</i> Analog Input (142) <i>Cur</i> Current (22) <i>Pwr</i> PID Power (73) <i>Lin</i> Linearization (238) <i>Math</i> Math (240) <i>Pu</i> Process Value (241) <i>Var</i> Variable (245) <i>Cur</i> Current Read is Sample Hold (179) <i>Watt</i> Wattage (1697) <i>LdVo</i> Load Voltage (1698) <i>Ldr</i> Load Resistance (1183)	Analog Input	2562 [offset 60]	0x6D (109) 1 to 16 0x11 (17)	21	9017	uint RWES
<i>iS.A</i> iS.A	<i>Alarm (1 to 16)</i> <b>Alarm Source Instance</b> Set the instance of the function selected above.	1 to 250	1	2564 [offset 60]	0x6D (109) 1 to 16 0x12 (18)	22	9018	uint RWES

\* These parameters/prompts are available in these menus with firmware revisions 6.0 and above.

\*\* R: Read, W: Write, E: EEPROM, S: User Set

**RM Limit Module • Setup Page**

Display	Parameter Name Description	Range	Default	Modbus Relative Address	CIP - Class Instance Attribute hex (dec)	Pro-fibus Index	Parameter ID	Data Type and Access **
<b>SZ</b> SZ	<b>Alarm (1 to 16) Alarm Source Zone</b> Set the zone of the function selected above.	0 to 24	0	2578 [offset 60]	0x6D (109) 1 to 16 0x19 (25)	- - - -	9025	uint RWES
<b>A.hy</b> A.hy	<b>Alarm (1 to 16) Hysteresis</b> Set the hysteresis for an alarm. This determines how far into the safe region the process value needs to move before the alarm can be cleared.	0.001 to 9,999.000 °F or units 0.001 to 5,555.000 °C	1.0 °F or units 1.0 °C	2534 [offset 60]	0x6D (109) 1 to 16 3	24	9003	float RWES
<b>A.Lg</b> A.Lg	<b>Alarm (1 to 16) Logic</b> Select what the output condition will be during the alarm state.	<b>ALC</b> Close On Alarm (17) <b>ALo</b> Open On Alarm (66)	Close On Alarm	2538 [offset 60]	0x6D (109) 1 to 16 5	25	9005	uint RWES
<b>A.Sd</b> A.Sd	<b>Alarm (1 to 16) Sides</b> Select which side or sides will trigger this alarm.	<b>both</b> Both (13) <b>high</b> High (37) <b>low</b> Low (53)	Both	2536 [offset 60]	0x6D (109) 1 to 16 4	26	9004	uint RWES
<b>A.Lo</b> A.Lo	<b>Alarm (1 to 16) Low Set Point *</b> If Alarm Type (Setup Page, Alarm Menu) is set to: <b>Process</b> - set the process value that will trigger a low alarm.	-1,999.000 to 9,999.000 °F or units -1,128.000 to 5,537.000 °C	32.0 °F or units 0.0 °C	2532 [offset 60]	0x6D (109) 1 to 16 2	18	9002	float RWES

\* These parameters/prompts are available in these menus with firmware revisions 6.0 and above.

\*\* R: Read, W: Write, E: EEPROM, S: User Set

**RM Limit Module • Setup Page**

Display	Parameter Name Description	Range	Default	Modbus Relative Address	CIP - Class Instance Attribute hex (dec)	Pro-fibus Index	Parameter ID	Data Type and Access **
<b>A.hi</b> A.hi	<b>Alarm (1 to 16) High Set Point</b> If Alarm Type (Setup Page, Alarm Menu) is set to: <b>Process</b> - set the process value that will trigger a high alarm.	-1,999.000 to 9,999.000°F or units -1,128.000 to 5,537.000°C	300.0°F or units 150.0°C	2530 [offset 60]	0x6D (109) 1 to 16 1	19	9001	float RWES
<b>A.LA</b> A.LA	<b>Alarm (1 to 16) Latching</b> Turn alarm latching on or off. A latched alarm has to be turned off by the user.	<b>nLAt</b> Non-Latching (60) <b>LAt</b> Latching (49)	Non-Latching	2542 [offset 60]	0x6D (109) 1 to 16 7	27	9007	uint RWES
<b>A.bL</b> A.bL	<b>Alarm (1 to 16) Blocking</b> Select when an alarm will be blocked. After startup and/ or after the set point changes, the alarm will be blocked until the process value enters the normal range.	<b>oFF</b> Off (62) <b>StAr</b> Startup (88) <b>StPt</b> Set Point (85) <b>boTh</b> Both (13)	Off	2544 [offset 60]	0x6D (109) 1 to 16 8	28	9008	uint RWES
<b>A.Si</b> A.Si	<b>Alarm (1 to 16) Silencing</b> Turn alarm silencing on to allow the user to disable this alarm.	<b>oFF</b> Off (62) <b>oN</b> On (63)	Off	2540 [offset 60]	0x6D (109) 1 to 16 6	29	9006	uint RWES
<b>A.dSP</b> A.dSP	<b>Alarm (1 to 16) Display</b> Display an alarm message when an alarm is active.	<b>oFF</b> Off (62) <b>oN</b> On (63)	On	2560 [offset 60]	0x6D (109) 1 to 16 0x10 (16)	30	9016	uint RWES

\* These parameters/prompts are available in these menus with firmware revisions 6.0 and above.

\*\* R: Read, W: Write, E: EEPROM, S: User Set

**RM Limit Module • Setup Page**

Display	Parameter Name Description	Range	Default	Modbus Relative Address	CIP - Class Instance Attribute hex (dec)	Pro-fibus Index	Parameter ID	Data Type and Access **
<i>A.dL</i> A.dL	<i>Alarm (1 to 16)</i> <b>Delay Time</b> Set the span of time that the alarm will be delayed after the process value exceeds the alarm set point.	0 to 9,999 seconds	0	2570 [offset 60]	0x6D (109) 1 to 16 0x15 (21)	31	9021	uint RWES
<i>A.CLr</i> A.CLr	<i>Alarm (1 to 16)</i> <b>Clear Alarm</b> Write to this register to clear an alarm	0	Ignore	2554 [offset 60]	0x6D (109) 1 to 24 0x0D (13)	32	9026	uint W
<i>A.Sir</i> A.Sir	<i>Alarm (1 to 16)</i> <b>Silence Alarm</b> Write to this register to silence an alarm	0	Ignore	2556 [offset 60]	0x6D (109) 1 to 24 0x0E (14)	33	9027	uint W
<i>A.St</i> A.St	<i>Alarm (1 to 16)</i> <b>Alarm State</b> Current state of alarm	<i>St</i> r Startup (88) <i>nonE</i> None (61) <i>bl</i> o Blocked (12) <i>ALL</i> Alarm low (8) <i>ALh</i> Alarm high (7) <i>AL</i> E Error (28)	- - - -	2546 [offset 60]	0x6D (109) 1 to 24 9	- - - -	9009	uint R
<i>Lnr</i> <i>SEt</i> <b>Linearization Menu</b>								
<i>Fn</i> Fn	<i>Linearization (1 to 16)</i> <b>Function</b> Set how this function will linearize Source A.	<i>oFF</i> Off (62) <i>int</i> r Interpolated (1482) <i>StP</i> d Stepped (1483)	Off	7998 [offset 70]	0x86 (134) 1 to 16 5	- - - -	34005	uint RWES

\* These parameters/prompts are available in these menus with firmware revisions 6.0 and above.

\*\* R: Read, W: Write, E: EEPROM, S: User Set

**RM Limit Module • Setup Page**

Display	Parameter Name Description	Range	Default	Modbus Relative Address	CIP - Class Instance Attribute hex (dec)	Pro-fibus Index	Parameter ID	Data Type and Access **
<b>SFn.A</b> SFn.A	<b>Linearization (1 to 16)</b> <b>Source Function A</b> Set the type of function that will be used for this source.	<i>nonE</i> None (61) <i>vAr</i> Variable (245) <i>SP.o</i> Set Point Open (243) <i>SP.C</i> Set Point Closed (242) <i>Pv</i> Process Value (241) <i>MAth</i> Math (240) <i>Linr</i> Linearization (238) <i>Pwr</i> Power (73) <i>hPr</i> Heat Power (160) <i>CPr</i> Cool Power (161) <i>Curr</i> Current (22) <i>AI</i> Analog Input (142)	None	7990 [offset 70]	0x86 (134) 1 to 16 1	155	34001	uint RWES
<b>Si.A</b> Si.A	<b>Linearization (1 to 16)</b> <b>Source Instance A</b> Set the instance of the function selected above.	1 to 250	1	7992 [offset 70]	0x86 (134) 1 to 16 2	- - - -	34002	uint RWES
<b>SZ.A</b> SZ.A	<b>Linearization (1 to 16)</b> <b>Source Zone A</b> Set the zone of the function selected above.	0 to 24	0	7994 [offset 70]	0x86 (134) 1 to 16 3	- - - -	34003	uint RWES
<b>Unit</b> Unit	<b>Linearization (1 to 16)</b> <b>Units</b> Set the units of the output value.	<i>rh</i> Relative Humidity (1538) <i>Pro</i> Process (75) <i>Pwr</i> Power (73) <i>r.tP</i> Relative Temperature (1541) <i>A.tP</i> Absolute Temperature (1540)  <i>Src</i> Source (1539) <i>nonE</i> None (61)	Source	8046 [offset 70]	0x86 (134) 1 to 16 0x1D (29)	156	34029	uint RWES
<b>ip.1</b> ip.1	<b>Linearization (1 to 16)</b> <b>Input Point 1</b> Set the value that will be mapped to output 1.	-1,999.000 to 9,999.000	0.0	8004 [offset 70]	0x86 (134) 1 to 16 8	157	34008	float RWES

\* These parameters/prompts are available in these menus with firmware revisions 6.0 and above.

\*\* R: Read, W: Write, E: EEPROM, S: User Set

**RM Limit Module • Setup Page**

Display	Parameter Name Description	Range	Default	Modbus Relative Address	CIP - Class Instance Attribute hex (dec)	Pro-fibus Index	Parameter ID	Data Type and Access **
<b>o.P.1</b> op.1	<i>Linearization (1 to 16)</i> <b>Output Point 1</b> Set the value that will be mapped to input 1.	-1,999.000 to 9,999.000	0.0	8024 [offset 70]	0x86 (134) 1 to 16 0x12 (18)	158	34018	float RWES
<b>i.P.2</b> ip.2	<i>Linearization (1 to 16)</i> <b>Input Point 2</b> Set the value that will be mapped to output 2.	-1,999.000 to 9,999.000	1.0	8006 [offset 70]	0x86 (134) 1 to 16 9	159	34009	float RWES
<b>o.P.2</b> op.2	<i>Linearization (1 to 16)</i> <b>Output Point 2</b> Set the value that will be mapped to input 2.	-1,999.000 to 9,999.000	1.0	8026 [offset 70]	0x86 (134) 1 to 16 0x13 (19)	160	34019	float RWES
<b>i.P.3</b> ip.3	<i>Linearization (1 to 16)</i> <b>Input Point 3</b> Set the value that will be mapped to output 3.	-1,999.000 to 9,999.000	2.0	8008 [offset 70]	0x86 (134) 1 to 16 0xA (10)	161	34010	float RWES
<b>o.P.3</b> op.3	<i>Linearization (1 to 16)</i> <b>Output Point 3</b> Set the value that will be mapped to input 3.	-1,999.000 to 9,999.000	2.0	8028 [offset 70]	0x86 (134) 1 to 16 0x14 (20)	162	34020	float RWES
<b>i.P.4</b> ip.4	<i>Linearization (1 to 16)</i> <b>Input Point 4</b> Set the value that will be mapped to output 4.	-1,999.000 to 9,999.000	3.0	8010 [offset 70]	0x86 (134) 1 to 16 0xB (11)	163	34011	float RWES
<b>o.P.4</b> op.4	<i>Linearization (1 to 16)</i> <b>Output Point 4</b> Set the value that will be mapped to input 4.	-1,999.000 to 9,999.000	3.0	8030 [offset 70]	0x86 (134) 1 to 16 0x15 (21)	164	34021	float RWES

\* These parameters/prompts are available in these menus with firmware revisions 6.0 and above.

\*\* R: Read, W: Write, E: EEPROM, S: User Set

**RM Limit Module • Setup Page**

Display	Parameter Name Description	Range	Default	Modbus Relative Address	CIP - Class Instance Attribute hex (dec)	Pro-fibus Index	Parameter ID	Data Type and Access **
<b>.P.5</b> ip.5	<i>Linearization (1 to 16)</i> <b>Input Point 5</b> Set the value that will be mapped to output 5.	-1,999.000 to 9,999.000	4.0	8012 [offset 70]	0x86 (134) 1 to 16 0xC (12)	165	34012	float RWES
<b>o.P.5</b> op.5	<i>Linearization (1 to 16)</i> <b>Output Point 5</b> Set the value that will be mapped to input 5.	-1,999.000 to 9,999.000	4.0	8032 [offset 70]	0x86 (134) 1 to 16 0x16 (22)	166	34022	float RWES
<b>.P.6</b> ip.6	<i>Linearization (1 to 16)</i> <b>Input Point 6</b> Set the value that will be mapped to output 6.	-1,999.000 to 9,999.000	5.0	8014 [offset 70]	0x86 (134) 1 to 16 0xD (13)	167	34013	float RWES
<b>o.P.6</b> op.6	<i>Linearization (1 to 16)</i> <b>Output Point 6</b> Set the value that will be mapped to input 6.	-1,999.000 to 9,999.000	5.0	8034 [offset 70]	0x86 (134) 1 to 16 0x17 (23)	168	34023	float RWES
<b>.P.7</b> ip.7	<i>Linearization (1 to 16)</i> <b>Input Point 7</b> Set the value that will be mapped to output 7.	-1,999.000 to 9,999.000	6.0	8016 [offset 70]	0x86 (134) 1 to 16 E (14)	169	34014	float RWES
<b>o.P.7</b> op.7	<i>Linearization (1 to 16)</i> <b>Output Point 7</b> Set the value that will be mapped to input 7.	-1,999.000 to 9,999.000	6.0	8036 [offset 70]	0x86 (134) 1 to 16 0x18 (24)	170	34024	float RWES
<b>.P.8</b> ip.8	<i>Linearization (1 to 16)</i> <b>Input Point 8</b> Set the value that will be mapped to output 8.	-1,999.000 to 9,999.000	7.0	8018 [offset 70]	0x86 (134) 1 to 16 0xF (15)	171	34015	float RWES

\* These parameters/prompts are available in these menus with firmware revisions 6.0 and above.

\*\* R: Read, W: Write, E: EEPROM, S: User Set



**RM Limit Module • Setup Page**

Display	Parameter Name Description	Range	Default	Modbus Relative Address	CIP - Class Instance Attribute hex (dec)	Pro-fibus Index	Parameter ID	Data Type and Access **
<b>oP.8</b> op.8	<i>Linearization (1 to 16)</i> <b>Output Point 8</b> Set the value that will be mapped to input 8.	-1,999.000 to 9,999.000	7.0	8038 [offset 70]	0x86 (134) 1 to 16 0x19 (25)	172	34025	float RWES
<b>.iP.9</b> ip.9	<i>Linearization (1 to 16)</i> <b>Input Point 9</b> Set the value that will be mapped to output 9.	-1,999.000 to 9,999.000	8.0	8020 [offset 70]	0x86 (134) 1 to 16 0x10 (16)	173	34016	float RWES
<b>oP.9</b> op.9	<i>Linearization (1 to 16)</i> <b>Output Point 9</b> Set the value that will be mapped to input 9.	-1,999.000 to 9,999.000	8.0	8040 [offset 70]	0x86 (134) 1 to 16 0x1A (26)	174	34026	float RWES
<b>.iP.10</b> ip.10	<i>Linearization (1 to 16)</i> <b>Input Point 10</b> Set the value that will be mapped to output 10.	-1,999.000 to 9,999.000	9.0	8022 [offset 70]	0x86 (134) 1 to 16 0x11 (17)	175	34017	float RWES
<b>oP.10</b> op.10	<i>Linearization (1 to 16)</i> <b>Output Point 10</b> Set the value that will be mapped to input 10.	-1,999.000 to 9,999.000	9.0	8042 [offset 70]	0x86 (134) 1 to 16 0x1B (27)	176	34027	float RWES

**CPE**  
**SET**

**Compare Menu**

<b>F<sub>n</sub></b> Fn	<i>Compare (1 to 16)</i> <b>Function</b> Set operator that will be used to compare Source A to Source B.	<b>oFF</b> Off (62) <b>LoE</b> Less or Equal (1440) <b>GoE</b> Greater or Equal (1439) <b>nE</b> Not Equal To (1438) <b>E</b> Equal To (1437) <b>Lt</b> Less Than (1436) <b>gt</b> Greater Than (1435)	Off	5926 [offset 40]	0x80 (128) 1 to 16 9	223	28009	uint RWES
----------------------------	--	--	-----	---------------------	----------------------------	-----	-------	--------------

\* These parameters/prompts are available in these menus with firmware revisions 6.0 and above.

\*\* R: Read, W: Write, E: EEPROM, S: User Set

**RM Limit Module • Setup Page**

Display	Parameter Name Description	Range	Default	Modbus Relative Address	CIP - Class Instance Attribute hex (dec)	Pro- fibus Index	Param- eter ID	Data Type and Access **
<b>toL</b> toL	<i>Compare (1 to 16)</i> <b>Tolerance</b> If the difference between Source A and Source B is less than this value the two will appear to be equal.	0 to 9,999.000	0.1	5930 [offset 40]	0x80 (128) 1 to 16 0xB (11)	230	28011	float RWES
<b>SFn.A</b> SFn.A	<i>Compare (1 to 16)</i> <b>Source Function A</b> Set the type of function that will be used for this source.	<i>none</i> None (61) <i>Ai</i> Analog Input (142) <i>Cur</i> Current (22) <i>CP</i> Cool Power (161) <i>HP</i> Heat Power (160) <i>Pwr</i> Power (73) <i>Lin</i> Linearization (238) <i>Math</i> Math (240) <i>PV</i> Process Value (241) <i>SPC</i> Set Point Closed (242) <i>SPO</i> Set Point Open (243) <i>Var</i> Variable (245) <i>Watt</i> Wattage (1697) <i>LdVo</i> Load Voltage (1698) <i>Ldr</i> Load Resistance (1183)	None	5910 [offset 40]	0x80 (128) 1 to 16 1	- - - -	28001	uint RWES
<b>Si.A</b> Si.A	<i>Compare (1 to 16)</i> <b>Source Instance A</b> Set the instance of the function selected above.	1 to 250	1	5914 [offset 40]	0x80 (128) 1 to 16 3	- - - -	28003	uint RWES
<b>SZ.A</b> SZ.A	<i>Compare (1 to 16)</i> <b>Source Zone A</b> Set the zone of the function selected above.	0 to 24	0	5918 [offset 40]	0x80 (128) 1 to 16 5	- - - -	28005	uint RWES

\* These parameters/prompts are available in these menus with firmware revisions 6.0 and above.

\*\* R: Read, W: Write, E: EEPROM, S: User Set

**RM Limit Module • Setup Page**

Display	Parameter Name Description	Range	Default	Modbus Relative Address	CIP - Class Instance Attribute hex (dec)	Pro-fibus Index	Param-eter ID	Data Type and Access **
<b>SFn.b</b> SFn.b	<i>Compare (1 to 16)</i> <b>Source Function B</b> Set the type of function that will be used for this source. This represents the timer reset signal.	<i>none</i> None (61) <i>A.i</i> Analog Input (142) <i>Curr</i> Current (22) <i>CP</i> Cool Power (161) <i>hPr</i> Heat Power (160) <i>PLPr</i> Power (73) <i>Lnr</i> Linearization (238) <i>MATH</i> Math (240) <i>Pv</i> Process Value (241) <i>SP.C</i> Set Point Closed (242) <i>SP.o</i> Set Point Open (243) <i>vAr</i> Variable (245) <i>WAT</i> Wattage (1697) <i>LdVo</i> Load Voltage (1698) <i>Ldr</i> Load Resistance (1183)	None	5912 [offset 40]	0x80 (128) 1 to 16 2	- - - -	28002	uint RWES
<b>Si.b</b> Si.b	<i>Compare (1 to 16)</i> <b>Source Instance B</b> Set the instance of the function selected above.	1 to 250	1	5916 [offset 40]	0x80 (128) 1 to 16 4	- - - -	28004	uint RWES
<b>SZ.b</b> SZ.b	<i>Compare (1 to 16)</i> <b>Source Zone B</b> Set the zone of the function selected above.	0 to 24	0	5920 [offset 40]	0x80 (128) 1 to 16 6	- - - -	28006	uint RWES
<b>Er.h</b> Er.h	<i>Compare (1 to 16)</i> <b>Error Handling</b> Use Error Handling to select the output value and error output state of this function if it receives an error signal from one or more sources and it cannot determine the output value.	<i>t.g</i> True Good (1476) <i>t.b</i> True Bad (1477) <i>f.g</i> False Good (1478) <i>f.b</i> False Bad (1479)	False Bad	5932 [offset 40]	0x80 (128) 1 to 16 0xC (12)	- - - -	28012	uint RWES

\* These parameters/prompts are available in these menus with firmware revisions 6.0 and above.

\*\* R: Read, W: Write, E: EEPROM, S: User Set

**RM Limit Module • Setup Page**

Display	Parameter Name Description	Range	Default	Modbus Relative Address	CIP - Class Instance Attribute hex (dec)	Pro-fibus Index	Parameter ID	Data Type and Access **
<p><i>Er</i> <i>SEt</i> <b>Timer Menu</b></p>								
<i>Fn</i> Fn	<i>Timer (1 to 16)</i> <b>Function</b> Set how the timer will function.	<i>oFF</i> Off (62) <i>oNp</i> On Pulse (1471) <i>dEL</i> Delay (1472) <i>aS</i> One Shot (1473) <i>rEt</i> Retentive (1474)	Off	7206 [offset 50]	0x83 (131) 1 to 16 9	223	31009	uint RWES
<i>SFnA</i> SFn.A	<i>Timer (1 to 16)</i> <b>Source Function A</b> Set the type of function that will be used for this source. This represents the timer run signal.	<i>nonE</i> None (61) <i>ALP</i> Alarm (6) <i>CPE</i> Compare (230) <i>Ctr</i> Counter (231) <i>diO</i> Digital I/O (1142) <i>EntA</i> Profile Event Out A (233) <i>EntB</i> Profile Event Out B (234) <i>EntC</i> Profile Event Out C (235) <i>EntD</i> Profile Event Out D (236) <i>EntE</i> Profile Event Out E (247) <i>EntF</i> Profile Event Out F (248) <i>EntG</i> Profile Event Out G (249) <i>EntH</i> Profile Event Out H (250) <i>FUn</i> Function Key (1001) <i>LG</i> Logic (239) <i>Sof.1</i> Special Function Output 1 (1532) <i>Sof.2</i> Special Function Output 2 (1533) <i>Sof.3</i> Special Function Output 3 (1534) <i>Sof.4</i> Special Function Output 4 (1535) <i>Er</i> Timer (244) <i>hEr</i> Heater Error (184) <i>vAr</i> Variable (245)	None	7190 [offset 50]	0x83 (131) 1 to 16 1	- - - -	31001	uint RWES
<i>SiA</i> Si.A	<i>Timer (1 to 16)</i> <b>Source Instance A</b> Set the instance of the function selected above.	1 to 250	1	7194 [offset 50]	0x83 (131) 1 to 16 3	- - - -	31003	uint RWES

\* These parameters/prompts are available in these menus with firmware revisions 6.0 and above.

\*\* R: Read, W: Write, E: EEPROM, S: User Set

**RM Limit Module • Setup Page**

Display	Parameter Name Description	Range	Default	Modbus Relative Address	CIP - Class Instance Attribute hex (dec)	Pro-fibus Index	Parameter ID	Data Type and Access **
<i>SZ.A</i> SZ.A	<i>Timer (1 to 16)</i> <b>Source Zone A</b> Set the zone of the function selected above.	0 to 24	0	7198 [offset 50]	0x83 (131) 1 to 16 5	- - - -	31005	uint RWES
<i>SAS.A</i> SAS.A	<i>Timer (1 to 16)</i> <b>Run Active Level</b> Set what state will be read as on.	<i>hi</i> High (37) <i>lo</i> Low (53)	High	7210 [offset 50]	0x83 (131) 1 to 16 0xB (11)	- - - -	31011	uint RWES
<i>SFn.b</i> SFn.b	<i>Timer (1 to 16)</i> <b>Source Function B</b> Set the type of function that will be used to reset a retentive timer.	<i>none</i> None (61) <i>ALM</i> Alarm (6) <i>CP</i> Cool Power (161) <i>CPE</i> Compare (230) <i>Cr</i> Counter (231) <i>di</i> Digital I/O (1142) <i>Ent.A</i> Profile Event Out A (233) <i>Ent.B</i> Profile Event Out B (234) <i>Ent.C</i> Profile Event Out C (235) <i>Ent.D</i> Profile Event Out D (236) <i>Ent.E</i> Profile Event Out E (247) <i>Ent.F</i> Profile Event Out F (248) <i>Ent.G</i> Profile Event Out G (249) <i>Ent.H</i> Profile Event Out H (250) <i>FUn</i> Function Key (1001) <i>LG</i> Logic (239) <i>Sof.1</i> Special Function Output 1 (1532) <i>Sof.2</i> Special Function Output 2 (1533) <i>Sof.3</i> Special Function Output 3 (1534) <i>Sof.4</i> Special Function Output 4 (1535) <i>TPTr</i> Timer (244) <i>HEr</i> Heater Error (184) <i>uAr</i> Variable (245)	None	7192 [offset 50]	0x83 (131) 1 to 16 2	- - - -	31002	uint RWES
<i>Si.b</i> Si.b	<i>Timer (1 to 16)</i> <b>Source Instance B</b> Set the instance of the function selected above.	1 to 250	1	7196 [offset 50]	0x83 (131) 1 to 16 4	- - - -	31004	uint RWES

\* These parameters/prompts are available in these menus with firmware revisions 6.0 and above.

\*\* R: Read, W: Write, E: EEPROM, S: User Set

**RM Limit Module • Setup Page**

Display	Parameter Name Description	Range	Default	Modbus Relative Address	CIP - Class Instance Attribute hex (dec)	Pro-fibus Index	Parameter ID	Data Type and Access **
<b>SZ.b</b> SZ.b	<i>Timer (1 to 16)</i> <b>Source Zone B</b> Set the zone of the function selected above.	0 to 24	0	7200 [offset 50]	0x83 (131) 1 to 16 6	- - - -	31006	uint RWES
<b>SAS.b</b> SAS.b	<i>Timer (1 to 16)</i> <b>Reset Active Level</b> Set what state will be read as on.	<b>h 19h</b> High (37) <b>L 0b</b> Low (53)	High	7212 [offset 50]	0x83 (131) 1 to 16 0xC (12)	- - - -	31012	uint RWES
<b>ti</b> ti	<i>Timer (1 to 16)</i> <b>Time</b> Set the time span that will be measured in tenths of a second.	0 to 9,999.000	0.1	7214 [offset 50]	0x83 (131) 1 to 16 0xD (13)	224	31013	float RWES
<b>LEV</b> LEV	<i>Timer (1 to 16)</i> <b>Transmitter Active Level</b> Set which output state will indicate on.	<b>h 19h</b> High (37) <b>L 0b</b> Low (53)	High	7216 [offset 50]	0x83 (131) 1 to 16 0xE (14)	- - - -	31014	uint RWES

**Ctr**  
**SEt**

**Counter Menu**

<b>Fn</b> Fn	<i>Counter (1 to 16)</i> <b>Function</b> Set whether the counter increments or decrements the count value. Decrementing 0 returns 9,999. Incrementing 9,999 returns 0.	<b>UP</b> Up (1456) <b>dn</b> Down (1457)	Up	6566 [offset 40]	0x82 (130) 1 to 16 9	- - - -	30009	uint RWES
-----------------	--	--	----	---------------------	----------------------------	---------	-------	--------------

\* These parameters/prompts are available in these menus with firmware revisions 6.0 and above.

\*\* R: Read, W: Write, E: EEPROM, S: User Set

**RM Limit Module • Setup Page**

Display	Parameter Name Description	Range	Default	Modbus Relative Address	CIP - Class Instance Attribute hex (dec)	Pro-fibus Index	Parameter ID	Data Type and Access **
<b>SFn.A</b> SFn.A	<i>Counter (1 to 16)</i> <b>Source Function A</b> Set the type of function that will be used for the counter clock signal.	<i>none</i> None (61) <i>ALM</i> Alarm (6) <i>CPE</i> Compare (230) <i>ctr</i> Counter (231) <i>dio</i> Digital I/O (1142) <i>Ent.A</i> Profile Event Out A (233) <i>Ent.b</i> Profile Event Out B (234) <i>Ent.C</i> Profile Event Out C (235) <i>Ent.d</i> Profile Event Out D (236) <i>Ent.E</i> Profile Event Out E (247) <i>Ent.F</i> Profile Event Out F (248) <i>Ent.G</i> Profile Event Out G (249) <i>Ent.h</i> Profile Event Out H (250) <i>FUn</i> Function Key (1001) <i>LGE</i> Logic (239) <i>tPTr</i> Timer (244) <i>hEr</i> Heater Error (184) <i>vAr</i> Variable (245)	None	6550 [offset 40]	0x82 (130) 1 to 16 1	- - - -	30001	uint RWES
<b>Si.A</b> Si.A	<i>Counter (1 to 16)</i> <b>Source Instance A</b> Set the instance of the function selected above.	1 to 250	1	6554 [offset 40]	0x82 (130) 1 to 16 3	- - - -	30003	uint RWES
<b>SZ.A</b> SZ.A	<i>Counter (1 to 16)</i> <b>Source Zone A</b> Set the zone of the function selected above.	0 to 24	0	6558 [offset 40]	0x82 (130) 1 to 16 5	- - - -	30005	uint RWES
<b>SAS.A</b> SAS.A	<i>Counter (1 to 16)</i> <b>Count Active Level</b> Set what output state will indicate on.	<i>high</i> High (37) <i>low</i> Low (53) <i>both</i> Both (130)	High	6570 [offset 40]	0x82 (130) 1 to 16 0xB (11)	- - - -	30011	uint RWES

\* These parameters/prompts are available in these menus with firmware revisions 6.0 and above.

\*\* R: Read, W: Write, E: EEPROM, S: User Set

**RM Limit Module • Setup Page**

Display	Parameter Name Description	Range	Default	Modbus Relative Address	CIP - Class Instance Attribute hex (dec)	Pro- fibus Index	Param- eter ID	Data Type and Access **
<i>SFn.b</i> SFn.b	<i>Counter (1 to 16)</i> <b>Source Function B</b> Set the type of function that will be used for the counter load signal.	<i>none</i> None (61) <i>ALPn</i> Alarm (6) <i>CPE</i> Compare (230) <i>ctr</i> Counter (231) <i>dio</i> Digital I/O (1142) <i>Ent.A</i> Profile Event Out A (233) <i>Ent.b</i> Profile Event Out B (234) <i>Ent.C</i> Profile Event Out C (235) <i>Ent.d</i> Profile Event Out D (236) <i>Ent.E</i> Profile Event Out E (247) <i>Ent.F</i> Profile Event Out F (248) <i>Ent.G</i> Profile Event Out G (249) <i>Ent.h</i> Profile Event Out H (250) <i>Fun</i> Function Key (1001) <i>LG</i> Logic (239) <i>TPPr</i> Timer (244) <i>hEr</i> Heater Error (184) <i>vAr</i> Variable (245)	None	6552 [offset 40]	0x82 (130) 1 to 16 2	- - - -	30002	uint RWES
<i>Si.b</i> Si.b	<i>Counter (1 to 16)</i> <b>Source Instance B</b> Set the instance of the function selected above.	1 to 250	1	6556 [offset 40]	0x82 (130) 1 to 16 4	- - - -	30004	uint RWES
<i>SZ.b</i> SZ.b	<i>Counter (1 to 16)</i> <b>Source Zone B</b> Set the zone of the function selected above.	0 to 24	0	6560 [offset 40]	0x82 (130) 1 to 16 6	- - - -	30006	uint RWES
<i>SAS.b</i> SAS.b	<i>Counter (1 to 16)</i> <b>Reset Active Level</b> Set what output state will indicate on.	<i>high</i> High (37) <i>low</i> Low (53) <i>both</i> Both (130)	High	6572 [offset 40]	0x82 (130) 1 to 16 0x0C (12)	- - - -	30012	uint RWES
<i>LoAd</i> LoAd	<i>Counter (1 to 16)</i> <b>Load Value</b> Set the counter's initial value.	0 to 9,999	0	6574 [offset 40]	0x82 (130) 1 to 16 (13)	215	30013	uint RWES
<i>trgt</i> trgt	<i>Counter (1 to 16)</i> <b>Target Value</b> Set the value that will turn the output value on.	0 to 9,999	9,999	6576 [offset 40]	0x82 (130) 1 to 16 0xE (14)	216	30014	uint RWES

\* These parameters/prompts are available in these menus with firmware revisions 6.0 and above.

\*\* R: Read, W: Write, E: EEPROM, S: User Set



**RM Limit Module • Setup Page**

Display	Parameter Name Description	Range	Default	Modbus Relative Address	CIP - Class Instance Attribute hex (dec)	Pro-fibus Index	Parameter ID	Data Type and Access **
<i>LAt</i> LAt	Counter (1 to 16) <b>Latching</b> Output latched.	<i>nO</i> No (59) <i>YES</i> Yes (106)	No	6582 [offset 40]	0x82 (130) 1 to 16 0x11 (17)	218	30017	uint RWES
<p><i>L9C</i> <i>SEt</i> <b>Logic Menu</b></p>								
<i>Fn</i> Fn	Logic (1 to 16) <b>Function</b> Set the operator that will be used to compare the sources.	<i>oFF</i> Off (62) <i>And</i> And (1426) <i>nAnd</i> Nand (1427) <i>oR</i> Or (1442) <i>nOR</i> Nor (1443) <i>E</i> Equal To (1437) <i>nE</i> Not Equal To (1438) <i>LAt</i> Latch (1444) <i>rSFF</i> RS Flip-Flop (1693)	Off	4694 [offset 80]	0x7F (127) 1 to 16 0x21 (33)	235	27033	uint RWES
<p>* These parameters/prompts are available in these menus with firmware revisions 6.0 and above. ** R: Read, W: Write, E: EEPROM, S: User Set</p>								

**RM Limit Module • Setup Page**

Display	Parameter Name Description	Range	Default	Modbus Relative Address	CIP - Class Instance Attribute hex (dec)	Pro- fibus Index	Param- eter ID	Data Type and Access **
<b>SFn.A</b> SFn.A	<b>Logic (1 to 16) Source Function A</b> Set the type of function that will be used for this source.	<i>none</i> None (61) <i>ALPn</i> Alarm (6) <i>CPE</i> Compare (230) <i>Ctr</i> Counter (231) <i>dio</i> Digital I/O (1142) <i>Ent.A</i> Profile Event Out A (233) <i>Ent.b</i> Profile Event Out B (234) <i>Ent.C</i> Profile Event Out C (235) <i>Ent.d</i> Profile Event Out D (236) <i>Ent.E</i> Profile Event Out E (247) <i>Ent.F</i> Profile Event Out F (248) <i>Ent.G</i> Profile Event Out G (249) <i>Ent.h</i> Profile Event Out H (250) <i>FUn</i> Function Key (1001) <i>L.Pn</i> Limit (126) <i>LG</i> Logic (239) <i>Sof.1</i> Special Function Output 1 (1532) <i>Sof.2</i> Special Function Output 2 (1533) <i>Sof.3</i> Special Function Output 3 (1534) <i>Sof.4</i> Special Function Output 4 (1535) <i>TPn</i> Timer (244) <i>hEr</i> Heater Error (184) <i>vAr</i> Variable (245)	None	4630 [offset 80]	0x7F (127) 1 to 16 1	- - - -	27001	uint RWES
<b>Si.A</b> Si.A	<b>Logic (1 to 16) Source Instance A</b> Set the instance of the function selected above.	1 to 250	1	4646 [offset 80]	0x7F (127) 1 to 16 9	- - - -	27009	uint RWES
<b>SZ.A</b> SZ.A	<b>Logic (1 to 16) Source Zone A</b> Set the zone of the function se- lected above.	0 to 24	0	4662 [offset 80]	0x7F (127) 1 to 16 0x11 (17)	- - - -	27017	uint RWES

\* These parameters/prompts are available in these menus with firmware revisions 6.0 and above.

\*\* R: Read, W: Write, E: EEPROM, S: User Set

**RM Limit Module • Setup Page**

Display	Parameter Name Description	Range	Default	Modbus Relative Address	CIP - Class Instance Attribute hex (dec)	Pro-fibus Index	Parameter ID	Data Type and Access **
<b>5Fn.b</b> SFn.b	<b>Logic (1 to 16) Source Function B</b> Set the type of function that will be used for this source.	<i>none</i> None (61) <i>ALPN</i> Alarm (6) <i>CPE</i> Compare (230) <i>CTR</i> Counter (231) <i>DI0</i> Digital I/O (1142) <i>Ent.A</i> Profile Event Out A (233) <i>Ent.B</i> Profile Event Out B (234) <i>Ent.C</i> Profile Event Out C (235) <i>Ent.D</i> Profile Event Out D (236) <i>Ent.E</i> Profile Event Out E (247) <i>Ent.F</i> Profile Event Out F (248) <i>Ent.G</i> Profile Event Out G (249) <i>Ent.H</i> Profile Event Out H (250) <i>FUN</i> Function Key (1001) <i>L.PN</i> Limit (126) <i>L9C</i> Logic (239) <i>Sof.1</i> Special Function Output 1 (1532) <i>Sof.2</i> Special Function Output 2 (1533) <i>Sof.3</i> Special Function Output 3 (1534) <i>Sof.4</i> Special Function Output 4 (1535) <i>tPTr</i> Timer (244) <i>hEr</i> Heater Error (184) <i>vAr</i> Variable (245)	None	4632 [offset 80]	0x7F (127) 1 to 16 2	- - - -	27002	uint RWES
<b>5.i.b</b> Si.b	<b>Logic (1 to 16) Source Instance B</b> Set the instance of the function selected above.	1 to 250	1	4648 [offset 80]	0x7F (127) 1 to 16 0xA (10)	- - - -	27010	uint RWES
<b>5Z.b</b> SZ.b	<b>Logic (1 to 16) Source Zone B</b> Set the zone of the function selected above	0 to 24	0	4664 [offset 80]	0x7F (127) 1 to 16 0x12 (18)	- - - -	27018	uint RWES

\* These parameters/prompts are available in these menus with firmware revisions 6.0 and above.

\*\* R: Read, W: Write, E: EEPROM, S: User Set

**RM Limit Module • Setup Page**

Display	Parameter Name Description	Range	Default	Modbus Relative Address	CIP - Class Instance Attribute hex (dec)	Pro-fibus Index	Parameter ID	Data Type and Access **
<b>SFn.C</b> SFn.C	<i>Logic (1 to 16)</i> <b>Source Function C</b> Set the type of function that will be used for this source.	<i>none</i> None (61) <i>ALPn</i> Alarm (6) <i>CPE</i> Compare (230) <i>Ctr</i> Counter (231) <i>dio</i> Digital I/O (1142) <i>Ent.A</i> Profile Event Out A (233) <i>Ent.B</i> Profile Event Out B (234) <i>Ent.C</i> Profile Event Out C (235) <i>Ent.D</i> Profile Event Out D (236) <i>Ent.E</i> Profile Event Out E (247) <i>Ent.F</i> Profile Event Out F (248) <i>Ent.G</i> Profile Event Out G (249) <i>Ent.H</i> Profile Event Out H (250) <i>FUn</i> Function Key (1001) <i>L i n</i> Limit (126) <i>LG</i> Logic (239) <i>Sof.1</i> Special Function Output 1 (1532) <i>Sof.2</i> Special Function Output 2 (1533) <i>Sof.3</i> Special Function Output 3 (1534) <i>Sof.4</i> Special Function Output 4 (1535) <i>TPn</i> Timer (244) <i>hEr</i> Heater Error (184) <i>vAr</i> Variable (245)	None	4634 [offset 80]	0x7F (127) 1 to 16 3	- - - -	27003	uint RWES
<b>Si.C</b> Si.C	<i>Logic (1 to 16)</i> <b>Source Instance C</b> Set the instance of the function selected above.	1 to 250	1	4650 [offset 80]	0x7F (127) 1 to 16 0xB (11)	- - - -	27011	uint RWES
<b>SZ.C</b> SZ.C	<i>Logic (1 to 16)</i> <b>Source Zone C</b> Set the zone of the function selected above.	0 to 24	0	4666 [offset 80]	0x7F (127) 1 to 16 0x13 (19)	- - - -	27019	uint RWES

\* These parameters/prompts are available in these menus with firmware revisions 6.0 and above.

\*\* R: Read, W: Write, E: EEPROM, S: User Set

**RM Limit Module • Setup Page**

Display	Parameter Name Description	Range	Default	Modbus Relative Address	CIP - Class Instance Attribute hex (dec)	Pro-fibus Index	Parameter ID	Data Type and Access **
<i>SFn.d</i> SFn.d	<i>Logic (1 to 16)</i> <b>Source Function D</b> Set the type of function that will be used for this source.	<i>none</i> None (61) <i>ALPN</i> Alarm (6) <i>CPE</i> Compare (230) <i>Ctr</i> Counter (231) <i>dio</i> Digital I/O (1142) <i>Ent.A</i> Profile Event Out A (233) <i>Ent.B</i> Profile Event Out B (234) <i>Ent.C</i> Profile Event Out C (235) <i>Ent.D</i> Profile Event Out D (236) <i>Ent.E</i> Profile Event Out E (247) <i>Ent.F</i> Profile Event Out F (248) <i>Ent.G</i> Profile Event Out G (249) <i>Ent.H</i> Profile Event Out H (250) <i>FUn</i> Function Key (1001) <i>L iPN</i> Limit (126) <i>L9C</i> Logic (239) <i>SoF.1</i> Special Function Output 1 (1532) <i>SoF.2</i> Special Function Output 2 (1533) <i>SoF.3</i> Special Function Output 3 (1534) <i>SoF.4</i> Special Function Output 4 (1535) <i>tPTr</i> Timer (244) <i>hEr</i> Heater Error (184) <i>vAr</i> Variable (245)	None	4636 [offset 80]	0x7F (127) 1 to 16 4	- - - -	27004	uint RWES
<i>Si.d</i> Si.d	<i>Logic (1 to 16)</i> <b>Source Instance D</b> Set the instance of the function selected above.	1 to 250	1	4652 [offset 80]	0x7F (127) 1 to 16 0xC (12)	- - - -	27012	uint RWES
<i>SZ.d</i> SZ.d	<i>Logic (1 to 16)</i> <b>Source Zone D</b> Set the zone of the function selected above.	0 to 24	0	4668 [offset 80]	0x7F (127) 1 to 16 0x14 (20)	- - - -	27020	uint RWES

\* These parameters/prompts are available in these menus with firmware revisions 6.0 and above.

\*\* R: Read, W: Write, E: EEPROM, S: User Set

**RM Limit Module • Setup Page**

Display	Parameter Name Description	Range	Default	Modbus Relative Address	CIP - Class Instance Attribute hex (dec)	Pro-fibus Index	Parameter ID	Data Type and Access **
<b>SFn.E</b> SFn.E	<b>Logic (1 to 16) Source Function E</b> Set the type of function that will be used for this source.	<i>none</i> None (61) <i>ALPn</i> Alarm (6) <i>CPE</i> Compare (230) <i>Ctr</i> Counter (231) <i>dio</i> Digital I/O (1142) <i>Ent.A</i> Profile Event Out A (233) <i>Ent.B</i> Profile Event Out B (234) <i>Ent.C</i> Profile Event Out C (235) <i>Ent.D</i> Profile Event Out D (236) <i>Ent.E</i> Profile Event Out E (247) <i>Ent.F</i> Profile Event Out F (248) <i>Ent.G</i> Profile Event Out G (249) <i>Ent.H</i> Profile Event Out H (250) <i>FUn</i> Function Key (1001) <i>L i P n</i> Limit (126) <i>LG</i> Logic (239) <i>Sof.1</i> Special Function Output 1 (1532) <i>Sof.2</i> Special Function Output 2 (1533) <i>Sof.3</i> Special Function Output 3 (1534) <i>Sof.4</i> Special Function Output 4 (1535) <i>TPn</i> Timer (244) <i>hEr</i> Heater Error (184) <i>vAr</i> Variable (245)	None	4638 [offset 80]	0x7F (127) 1 to 16 5	- - - -	27005	uint RWES
<b>Si.E</b> Si.E	<b>Logic (1 to 16) Source Instance E</b> Set the instance of the function selected above.	1 to 250	1	4654 [offset 80]	0x7F (127) 1 to 16 D (13)	- - - -	27013	uint RWES
<b>SZ.E</b> SZ.E	<b>Logic (1 to 16) Source Zone E</b> Set the zone of the function selected above.	0 to 24	0	4670 [offset 80]	0x7F (127) 1 to 16 0x15 (21)	- - - -	27021	uint RWES

\* These parameters/prompts are available in these menus with firmware revisions 6.0 and above.

\*\* R: Read, W: Write, E: EEPROM, S: User Set

**RM Limit Module • Setup Page**

Display	Parameter Name Description	Range	Default	Modbus Relative Address	CIP - Class Instance Attribute hex (dec)	Pro-fibus Index	Parameter ID	Data Type and Access **
<i>SFn.F</i> SFn.F	<i>Logic (1 to 16)</i> <b>Source Function F</b> Set the type of function that will be used for this source.	<i>none</i> None (61) <i>ALPn</i> Alarm (6) <i>CPE</i> Compare (230) <i>Ctr</i> Counter (231) <i>dio</i> Digital I/O (1142) <i>Ent.a</i> Profile Event Out A (233) <i>Ent.b</i> Profile Event Out B (234) <i>Ent.c</i> Profile Event Out C (235) <i>Ent.d</i> Profile Event Out D (236) <i>Ent.e</i> Profile Event Out E (247) <i>Ent.f</i> Profile Event Out F (248) <i>Ent.g</i> Profile Event Out G (249) <i>Ent.h</i> Profile Event Out H (250) <i>FUn</i> Function Key (1001) <i>Lipn</i> Limit (126) <i>LG</i> Logic (239) <i>Sof.1</i> Special Function Output 1 (1532) <i>Sof.2</i> Special Function Output 2 (1533) <i>Sof.3</i> Special Function Output 3 (1534) <i>Sof.4</i> Special Function Output 4 (1535) <i>tpnr</i> Timer (244) <i>hEr</i> Heater Error (184) <i>uAr</i> Variable (245)	None	4640 [offset 80]	0x7F (127) 1 to 16 6	- - - -	27006	uint RWES
<i>Si.F</i> Si.F	<i>Logic (1 to 16)</i> <b>Source Instance F</b> Set the instance of the function selected above.	1 to 250	1	4656 [offset 80]	0x7F (127) 1 to 16 0xE (14)	- - - -	27014	uint RWES
<i>SF.F</i> SF.F	<i>Logic (1 to 16)</i> <b>Source Zone F</b> Set the zone of the function selected above.	0 to 24	0	4672 [offset 80]	0x7F (127) 1 to 16 0x16 (22)	- - - -	27022	uint RWES

\* These parameters/prompts are available in these menus with firmware revisions 6.0 and above.

\*\* R: Read, W: Write, E: EEPROM, S: User Set

**RM Limit Module • Setup Page**

Display	Parameter Name Description	Range	Default	Modbus Relative Address	CIP - Class Instance Attribute hex (dec)	Pro-fibus Index	Parameter ID	Data Type and Access **
<b>SFn.g</b> SFn.g	<b>Logic (1 to 16) Source Function G</b> Set the type of function that will be used for this source.	<i>none</i> None (61) <i>ALPn</i> Alarm (6) <i>CPE</i> Compare (230) <i>Ctr</i> Counter (231) <i>dio</i> Digital I/O (1142) <i>Ent.A</i> Profile Event Out A (233) <i>Ent.B</i> Profile Event Out B (234) <i>Ent.C</i> Profile Event Out C (235) <i>Ent.D</i> Profile Event Out D (236) <i>Ent.E</i> Profile Event Out E (247) <i>Ent.F</i> Profile Event Out F (248) <i>Ent.G</i> Profile Event Out G (249) <i>Ent.H</i> Profile Event Out H (250) <i>FUn</i> Function Key (1001) <i>L i n</i> Limit (126) <i>LG</i> Logic (239) <i>Sof.1</i> Special Function Output 1 (1532) <i>Sof.2</i> Special Function Output 2 (1533) <i>Sof.3</i> Special Function Output 3 (1534) <i>Sof.4</i> Special Function Output 4 (1535) <i>TPn</i> Timer (244) <i>hEr</i> Heater Error (184) <i>vAr</i> Variable (245)	None	4642 [offset 80]	0x7F (127) 1 to 16 7	- - - -	27007	uint RWES
<b>Si.g</b> Si.g	<b>Logic (1 to 16) Source Instance G</b> Set the instance of the function selected above.	1 to 250	1	4658 [offset 80]	0x7F (127) 1 to 16 0xF (15)	- - - -	27015	uint RWES
<b>SZ.g</b> SZ.g	<b>Logic (1 to 16) Source Zone G</b> Set the zone of the function selected above.	0 to 24	0	4674 [offset 80]	0x7F (127) 1 to 16 0x17 (23)	- - - -	27023	uint RWES

\* These parameters/prompts are available in these menus with firmware revisions 6.0 and above.

\*\* R: Read, W: Write, E: EEPROM, S: User Set



**RM Limit Module • Setup Page**

Display	Parameter Name Description	Range	Default	Modbus Relative Address	CIP - Class Instance Attribute hex (dec)	Pro-fibus Index	Parameter ID	Data Type and Access **
<b>5Fn.h</b> SFn.h	<i>Logic (1 to 16)</i> <b>Source Function H</b> Set the type of function that will be used for this source.	<i>none</i> None (61) <i>ALP</i> Alarm (6) <i>CPE</i> Compare (230) <i>Ctr</i> Counter (231) <i>dio</i> Digital I/O (1142) <i>Ent.A</i> Profile Event Out A (233) <i>Ent.B</i> Profile Event Out B (234) <i>Ent.C</i> Profile Event Out C (235) <i>Ent.D</i> Profile Event Out D (236) <i>Ent.E</i> Profile Event Out E (247) <i>Ent.F</i> Profile Event Out F (248) <i>Ent.G</i> Profile Event Out G (249) <i>Ent.H</i> Profile Event Out H (250) <i>FUn</i> Function Key (1001) <i>L i P</i> Limit (126) <i>L9C</i> Logic (239) <i>Sof.1</i> Special Function Output 1 (1532) <i>Sof.2</i> Special Function Output 2 (1533) <i>Sof.3</i> Special Function Output 3 (1534) <i>Sof.4</i> Special Function Output 4 (1535) <i>tPTr</i> Timer (244) <i>hEr</i> Heater Error (184) <i>vAr</i> Variable (245)	None	4644 [offset 80]	0x7F (127) 1 to 16 8	- - - -	27008	uint RWES
<b>5ih</b> Si.h	<i>Logic (1 to 16)</i> <b>Source Instance H</b> Set the instance of the function selected above.	1 to 250	1	4660 [offset 80]	0x7F (127) 1 to 16 0x10 (16)	- - - -	27016	uint RWES
<b>5zh</b> SZ.h	<i>Logic (1 to 16)</i> <b>Source Zone H</b> Set the zone of the function selected above.	0 to 24	0	4676 [offset 80]	0x7F (127) 1 to 16 0x18 (24)	- - - -	27024	uint RWES

\* These parameters/prompts are available in these menus with firmware revisions 6.0 and above.

\*\* R: Read, W: Write, E: EEPROM, S: User Set

**RM Limit Module • Setup Page**

Display	Parameter Name Description	Range	Default	Modbus Relative Address	CIP - Class Instance Attribute hex (dec)	Pro-fibus Index	Parameter ID	Data Type and Access **
<i>Er.h</i> Er.h	<i>Logic (1 to 16)</i> <b>Error Handling</b> Use to select the output value and error output state of this function if it receives an error signal from one or more sources and it cannot determine the output value.	<i>T.G</i> True Good (1476) <i>T.B</i> True Bad (1477) <i>F.G</i> False Good (1478) <i>F.B</i> False Bad (1479)	False Bad	4698 [offset 80]	0x7F (127) 1 to 16 0x23 (35)	- - - -	27035	uint RWES

*P.PAL*  
*SET*

**Math Menu**

<i>Fn</i> Fn	<i>Math (1 to 16)</i> <b>Function</b> Set the operator that will be applied to the sources.	<i>OFF</i> Off (62) <i>Avg</i> Average (1367) <i>P.S.C</i> Process Scale (1371) <i>d.S.C</i> Deviation Scale (1372) <i>So</i> Switch Over (1370) <i>d.i.FF</i> Differential (1373) <i>r.Rt.r</i> Ratio (1374) <i>Add</i> Add (1375) <i>P.M.U.L</i> Multiply (1376) <i>A.d.i.F</i> Absolute Difference (1377) <i>P.P.in</i> Minimum (1378) <i>P.P.A.H</i> Maximum (1379) <i>root</i> Square Root (1380) <i>hold</i> Sample and Hold (1381) <i>ALT</i> Pressure to Altitude (1649) <i>dELUJ</i> Dew Point (1650)	Off	3550 [offset 70]	0x7D (125) 1 to 16 0x15 (21)	128	25021	uint RWES
-----------------	---	---	-----	------------------------	--	-----	-------	--------------

\* These parameters/prompts are available in these menus with firmware revisions 6.0 and above.

\*\* R: Read, W: Write, E: EEPROM, S: User Set

**RM Limit Module • Setup Page**

Display	Parameter Name Description	Range	Default	Modbus Relative Address	CIP - Class Instance Attribute hex (dec)	Pro-fibus Index	Parameter ID	Data Type and Access **
<b>SFn.A</b> SFn.A	<b>Math (1 to 16) Source Function A</b> Set the type of function that will be used for this source.	<i>nonE</i> None (61) <i>Ai</i> Analog Input (142) <i>CUrr</i> Current (22) <i>CPrr</i> Cool Power, Control Loop (161) <i>hPr</i> Heat Power, Control Loop (160) <i>PLUr</i> Power, Control Loop (73) <i>Lnr</i> Linearization (238) <i>MAE</i> Math (240) <i>Pu</i> Process Value (241) <i>SPC</i> Set Point Closed, Control Loop (242) <i>SPo</i> Set Point Open, Control Loop (243) <i>uAr</i> Variable (245)	None	3510 [offset 70]	0x7D (125) 1 to 16 1	- - - -	25001	uint RWES
<b>Si.A</b> Si.A	<b>Math (1 to 16) Source Instance A</b> Set the instance of the function selected above.	1 to 250	1	3520 [offset 70]	0x7D (125) 1 to 16 6	- - - -	25006	uint RWES
<b>SZ.A</b> SZ.A	<b>Math (1 to 16) Source Zone A</b> Set the zone of the function selected above.	0 to 24	0	3530 [offset 70]	0x7D (125) 1 to 16 0xB (11)	- - - -	25011	uint RWES
<b>SFn.b</b> SFn.b	<b>Math (1 to 16) Source Function B</b> Set the type of function that will be used for this source.	<i>nonE</i> None (61) <i>Ai</i> Analog Input (142) <i>CUrr</i> Current (22) <i>CPrr</i> Cool Power, Control Loop (161) <i>hPr</i> Heat Power, Control Loop (160) <i>PLUr</i> Power, Control Loop (73) <i>Lnr</i> Linearization (238) <i>MAE</i> Math (240) <i>Pu</i> Process Value (241) <i>SPC</i> Set Point Closed, Control Loop (242) <i>SPo</i> Set Point Open, Control Loop (243) <i>uAr</i> Variable (245)	None	3512 [offset 70]	0x7D (125) 1 to 16 2	- - - -	25002	uint RWES

\* These parameters/prompts are available in these menus with firmware revisions 6.0 and above.

\*\* R: Read, W: Write, E: EEPROM, S: User Set

**RM Limit Module • Setup Page**

Display	Parameter Name Description	Range	Default	Modbus Relative Address	CIP - Class Instance Attribute hex (dec)	Pro-fibus Index	Parameter ID	Data Type and Access **
<b>5.i.b</b> Si.b	<i>Math (1 to 16)</i> <b>Source Instance B</b> Set the instance of the function selected above.	1 to 250	1	3522 [offset 70]	0x7D (125) 1 to 16 7	- - - -	25007	uint RWES
<b>52.b</b> SZ.b	<i>Math (1 to 16)</i> <b>Source Zone B</b> Set the zone of the function selected above.	0 to 24	0	3532 [offset 70]	0x7D (125) 1 to 16 0xC (12)	- - - -	25012	uint RWES
<b>5Fn.C</b> SFn.C	<i>Math (1 to 16)</i> <b>Source Function C</b> Set the type of function that will be used for this source.	<i>none</i> None (61) <i>Ai</i> Analog Input (142) <i>Cur</i> Current (22) <i>CP</i> Cool Power, Control Loop (161) <i>hP</i> Heat Power, Control Loop (160) <i>PL</i> Power, Control Loop (73) <i>Lin</i> Linearization (238) <i>MATH</i> Math (240) <i>PV</i> Process Value (241) <i>SP.C</i> Set Point Closed, Control Loop (242) <i>SP.O</i> Set Point Open, Control Loop (243) <i>VAR</i> Variable (245)	None	3514 [offset 70]	0x7D (125) 1 to 16 3	- - - -	25003	uint RWES
<b>5.i.C</b> Si.C	<i>Math (1 to 16)</i> <b>Source Instance C</b> Set the instance of the function selected above.	1 to 250	1	3524 [offset 70]	0x7D (125) 1 to 16 8	- - - -	25008	uint RWES
<b>52.C</b> SZ.C	<i>Math (1 to 16)</i> <b>Source Zone C</b> Set the zone of the function selected above.	0 to 24	0	3534 [offset 70]	0x7D (125) 1 to 16 0xD (13)	- - - -	25013	uint RWES

\* These parameters/prompts are available in these menus with firmware revisions 6.0 and above.

\*\* R: Read, W: Write, E: EEPROM, S: User Set

**RM Limit Module • Setup Page**

Display	Parameter Name Description	Range	Default	Modbus Relative Address	CIP - Class Instance Attribute hex (dec)	Pro-fibus Index	Parameter ID	Data Type and Access **
<i>SFn.d</i> SFn.d	<i>Math (1 to 16)</i> <b>Source Function D</b> Set the type of function that will be used for this source.	<i>nonE</i> None (61) <i>Ai</i> Analog Input (142) <i>Curr</i> Current (22) <i>CP</i> Cool Power, Control Loop (161) <i>hPr</i> Heat Power, Control Loop (160) <i>PLU</i> Power, Control Loop (73) <i>Lnr</i> Linearization (238) <i>MATH</i> Math (240) <i>Pv</i> Process Value (241) <i>SPC</i> Set Point Closed, Control Loop (242) <i>SPo</i> Set Point Open, Control Loop (243) <i>vAr</i> Variable (245)	None	3516 [offset 70]	0x7D (125) 1 to 16 4	- - - -	25004	uint RWES
<i>Si.d</i> Si.d	<i>Math (1 to 16)</i> <b>Source Instance D</b> Set the instance of the function selected above.	1 to 250	1	3526 [offset 70]	0x7D (125) 1 to 16 9	- - - -	25009	uint RWES
<i>SZ.d</i> SZ.d	<i>Math (1 to 16)</i> <b>Source Zone D</b> Set the zone of the function selected above.	0 to 24	0	3536 [offset 70]	0x7D (125) 1 to 16 0xE (14)	- - - -	25014	uint RWES
<i>SFn.E</i> SFn.E	<i>Math (1 to 16)</i> <b>Source Function E</b> Set the type of function that will be used for this source.	<i>nonE</i> None (61) <i>ALPA</i> Alarm (6) <i>CPE</i> Compare (230) <i>Ctr</i> Counter (231) <i>dio</i> Digital I/O (1142) <i>EntA</i> Profile Event Out A (233) <i>EntB</i> Profile Event Out B (234) <i>EntC</i> Profile Event Out C (235) <i>EntD</i> Profile Event Out D (236) <i>EntE</i> Profile Event Out E (247) <i>EntF</i> Profile Event Out F (248) <i>EntG</i> Profile Event Out G (249) <i>EntH</i> Profile Event Out H (250) <i>FUn</i> Function Key (1001) <i>LGE</i> Logic (239) <i>tPr</i> Timer (244) <i>vAr</i> Variable (245)	None	3518 [offset 70]	0x7D (125) 1 to 16 5	- - - -	25005	uint RWES

\* These parameters/prompts are available in these menus with firmware revisions 6.0 and above.

\*\* R: Read, W: Write, E: EEPROM, S: User Set

**RM Limit Module • Setup Page**

Display	Parameter Name Description	Range	Default	Modbus Relative Address	CIP - Class Instance Attribute hex (dec)	Pro- fibus Index	Param- eter ID	Data Type and Access **
<b>S<sub>i</sub>.E</b> Si.E	<i>Math (1 to 16)</i> <b>Source Instance E</b> Set the instance of the function selected above.	1 to 250	1	3528 [offset 70]	0x7D (125) 1 to 16 0xA (10)	- - - -	25010	uint RWES
<b>SZ.E</b> SZ.E	<i>Math (1 to 16)</i> <b>Source Zone E</b> Set the zone of the function se- lected above.	0 to 24	0	3538 [offset 70]	0x7D (125) 1 to 16 0xF (15)	- - - -	25015	uint RWES
<b>SLo</b> S.Lo	<i>Math (1 to 16)</i> <b>Scale Low</b> If Math function is set to Process Scale, this will scale Source A low value to Range Low set- ting.	-1,999.000 to 9,999.000	0.0	3556 [offset 70]	0x7D (125) 1 to 16 0x18 (24)	129	25024	float RWES
<b>S<sub>h</sub>i</b> S.hi	<i>Math (1 to 16)</i> <b>Scale High</b> If Math function is set to Process Scale, this will scale Source A high value to Range High set- ting.	-1,999.000 to 9,999.000	1.0	3558 [offset 70]	0x7D (125) 1 to 16 0x19 (25)	130	25025	float RWES
<b>rLo</b> r.Lo	<i>Math (1 to 16)</i> <b>Range Low</b> If Math function is set to Process Scale, this will output Source A Scale Low value to Range Low set- ting.	-1,999.000 to 9,999.000	0.0	3560 [offset 70]	0x7D (125) 1 to 16 0x1A (26)	131	25026	float RWES
<b>r<sub>h</sub>i</b> r.hi	<i>Math (1 to 16)</i> <b>Range High</b> If Math function is set to Process Scale, this will output Source A Scale High value to Range High setting.	-1,999.000 to 9,999.000	1.0	3562 [offset 70]	0x7D (125) 1 to 16 0x1B (27)	132	25027	float RWES

\* These parameters/prompts are available in these menus with firmware revisions 6.0 and above.

\*\* R: Read, W: Write, E: EEPROM, S: User Set

**RM Limit Module • Setup Page**

Display	Parameter Name Description	Range	Default	Modbus Relative Address	CIP - Class Instance Attribute hex (dec)	Pro-fibus Index	Parameter ID	Data Type and Access **
<i>P.un</i> P.unt	<i>Math (1 to 16)</i> <b>Pressure Units</b> If Math function is set for Pressure to Altitude units, set units of measure for conversion.	<i>PS</i> , Pressure Units (1671) <i>PA</i> sc Pascal (1674) <i>AT</i> m Atmosphere (1675) <i>m</i> bar (1672) <i>Torr</i> (1673)	Pressure Units	3568 [offset 70]	0x7D (125) 1 to 16 0x1E (30)	- - - -	25030	uint RWES
<i>A.un</i> A.unt	<i>Math (1 to 16)</i> <b>Altitude Units</b> If Math function is set for Pressure to Altitude units, set units of measure for conversion.	<i>KF</i> Kilofeet (1671) <i>F</i> Feet (1674)	Kilofeet	3570 [offset 70]	0x7D (125) 1 to 16 0x1F (31)	- - - -	25031	uint RWES
<i>F.iL</i> FiL	<i>Math (1 to 16)</i> <b>Filter</b> Filtering smooths out the output signal of this function block. Increase the time to increase filtering.	0.0 to 60.0 seconds	0.0	3564 [offset 70]	0x7D (125) 1 to 16 0x1C (28)	- - - -	25028	float RWES

*VAR*  
*SET*  
**Variable Menu**

<i>TYPE</i> type	<i>Variable (1 to 16)</i> <b>Data Type</b> Set the variable's data type.	<i>AN</i> Analog (1215) <i>D</i> Digital (1220)	Analog	9110 [offset 20]	0x66 (102) 1 to 16 1	210	2001	uint RWES
<i>Unit</i> Unit	<i>Variable (1 to 16)</i> <b>Units</b> Set the variable's units. Note: Units are always in degrees F when used for temperature	<i>AT</i> Absolute Temperature (1540) <i>RT</i> Relative Temperature (1541) <i>Power</i> (73) <i>Pro</i> Process (75) <i>rh</i> Relative Humidity (1538) <i>none</i> None (61)	Absolute Temperature	9122 [offset 20]	0x66 (102) 1 to 16 7	- - - -	2007	uint RWES
<i>D</i> dig	<i>Variable (1 to 16)</i> <b>Digital</b> Set the variable's value.	<i>OFF</i> Off (62) <i>ON</i> On (63)	Off	9112 [offset 20]	0x66 (102) 1 to 16 2	211	2002	uint RWES

\* These parameters/prompts are available in these menus with firmware revisions 6.0 and above.  
\*\* R: Read, W: Write, E: EEPROM, S: User Set

**RM Limit Module • Setup Page**

Display	Parameter Name Description	Range	Default	Modbus Relative Address	CIP - Class Instance Attribute hex (dec)	Pro-fibus Index	Parameter ID	Data Type and Access **
<b>AnLg</b> AnLg	<i>Variable (1 to 16)</i> <b>Analog</b> Set the variable's value.	-1,999.000 to 9,999.000	0.0	9114 [offset 20]	0x66 (102) 1 to 16 3	212	2003	float RWES
No Display	<i>Variable (1 to 16)</i> <b>Output Value</b>	Off (62) On (63) -1,999.000 to 9,999.000	- - - -	9116 [offset 20]	0x66 (102) 1 to 16 4	- - - -	2004	float R

**9L6L**  
**5Et**

**Global Menu**

<b>C_F</b> C_F	<i>Global</i> <b>Display Units</b> Select which scale to use for temperature.	<b>F</b> °F (30) <b>C</b> °C (15)	°F	368	0x67 (103) 1 5	110	3005	uint RWES
<b>AC.LF</b> AC.LF	<i>Global</i> <b>AC Line Frequency</b> Set the frequency to the applied ac line power source.	<b>50</b> 50 Hz (3) <b>60</b> 60 Hz (4)	60 Hz	- - - -	0x65 (101) 1 0x22(34)	- - - -	1034	uint RWES
<b>MAX</b> MAX	<i>Global</i> <b>Maximum Display Value</b> Allows ranges to be opened up to display full values. Prior to firmware revision 9.0, ranges were clamped to accommodate the seven segment LED display of the RUI. Typically used with external display devices/software like HMIs and SpecView.	Floating Point [-3.4E+38 to 3.4E+38]  Unsigned integer [0 to 65,535]	9999.0	- - - -	0x67 (103) 1 0x2D (45)	- - - -	3045	float RW

\* These parameters/prompts are available in these menus with firmware revisions 6.0 and above.  
\*\* R: Read, W: Write, E: EEPROM, S: User Set



**RM Limit Module • Setup Page**

Display	Parameter Name Description	Range	Default	Modbus Relative Address	CIP - Class Instance Attribute hex (dec)	Pro-fibus Index	Parameter ID	Data Type and Access **
<b>dPr.Min</b>	<b>Global Minimum Display Value</b> Allows ranges to be opened up to display full values. Prior to firmware revision 9.0, ranges were clamped to accommodate the seven segment LED display of the RUI. Typically used with external display devices/software like HMIs and SpecView.	Floating Point [-3.4E+38 to 3.4E+38]  Unsigned integer [0 to 65,535]	-1,999.0	-----	0x67 (103) 1 0x2C (44)	-----	3044	float RW
<b>dPr.S</b>	<b>Global Display Pairs</b> Defines the number of Display Pairs.	1 to 15	1	-----	0x67 (103) 1 0x1C (28)	-----	3028	uint RWES
<b>USr.S</b>	<b>Global Save Settings As</b> Save all of this controller's settings to the selected set that have a Data Type of RWES	<b>SEt 1</b> User Set 1 (101) <b>nonE</b> None (61)	None	26	0x65 (101) 1 0x0E (14)	118	1014	uint RWE
<b>USr.r</b>	<b>Global Restore Settings From</b> Replace all of this controller's settings with another set.	<b>nonE</b> None (61) <b>SEt 1</b> User Set 1 (101) <b>FACTY</b> Factory (31)  * Starting with firmware release 6, there is only one user set.	None	24	0x65 (101) 1 0xD (13)	117	1013	uint RWE

\* These parameters/prompts are available in these menus with firmware revisions 6.0 and above.

\*\* R: Read, W: Write, E: EEPROM, S: User Set

**RM Limit Module • Setup Page**

Display	Parameter Name Description	Range	Default	Modbus Relative Address	CIP - Class Instance Attribute hex (dec)	Pro- fibus Index	Param- eter ID	Data Type and Access **
<p><b>CoMm</b> <b>SEt</b> <b>Communications Menu</b></p>								
<b>bAUd</b> bAUd	<b>Communications Baud Rate</b> Set the speed of this controller's communications to match the speed of the se- rial network.	<b>9600</b> 9,600 (188) <b>192</b> 19,200 (189) <b>384</b> 38,400 (190)	9,600	3494	0x96 (150) 1 3	- - - -	17002	uint RWE
<b>PAR</b> PAR	<b>Communications Parity</b> Set the parity of this controller to match the parity of the serial net- work.  <b>Note:</b> This applies if 10th digit in part number is equal to one.	<b>nonE</b> None (61) <b>EuEn</b> Even (191) <b>odd</b> Odd (192)	None	3496	0x96 (150) 1 4	- - - -	17003	uint RWE
<b>M.hL</b> M.hL	<b>Communications Modbus Word Order</b> Select the word order of the two 16-bit words in the floating-point values.	<b>hiLo</b> Word High Low (1330) <b>LoHi</b> Word Low High (1331)	Low High	3498	0x96 (150) 1 5	- - - -	17043	uint RWE
<b>C_F</b> C_F	<b>Communications Display Units</b> Select which scale to use for temperature passed when using Modbus.	<b>F</b> °F (30) <b>C</b> °C (15)	°F	3500	0x96 (150) 1 6	- - - -	17050	uint RWE

\* These parameters/prompts are available in these menus with firmware revisions 6.0 and above.  
\*\* R: Read, W: Write, E: EEPROM, S: User Set

**RM Limit Module • Setup Page**

Display	Parameter Name Description	Range	Default	Modbus Relative Address	CIP - Class Instance Attribute hex (dec)	Pro-fibus Index	Param-eter ID	Data Type and Access **
nU.S nV.S	<p><i>Communications (1)</i></p> <p><b>Non-volatile Save</b> If set to Yes all values written to the control will be saved in EEPROM.</p> <p><b>Note:</b> Any value that is changed from the RUI or over a communications port will initiate a write to the EEPROM. Life of EEPROM is approximately one million writes.</p>	<p><i>YES</i> Yes (106)</p> <p><i>no</i> No (59)</p>	Yes	3504	0x96 (150) 1 8	198	17051	uint RWE

\* These parameters/prompts are available in these menus with firmware revisions 6.0 and above.













\*\* R: Read, W: Write, E: EEPROM, S: User Set

# 5

## Chapter 5: Factory Pages

### Limit Module Factory Page Parameters

To navigate to the Factory Page using the RUI, follow the steps below:

1. From the Home Page, press and hold both the Advance  and Infinity  keys for six seconds.
2. Press the Up  or Down  key to view available menus.
3. Press the Advance Key  to enter the menu of choice.
4. If a submenu exists (more than one instance), press the Up  or Down  key to select and then press the Advance Key  to enter.
5. Press the Up  or Down  key to move through available menu prompts.
6. Press the Infinity Key  to move backwards through the levels: parameter to submenu, submenu to menu, menu to Home Page.
7. Press and hold the Infinity Key  for two seconds to return to the Home Page.

On the following pages, top level menus are identified with a yellow background color.

#### Note:

Some of these menus and parameters may not appear, depending on the controller's options. See model number information in the Appendix for more information. If there is only one instance of a menu, no submenus will appear.

#### Note:

Some of the listed parameters may not be visible. Parameter visibility is dependent upon controller part number.

**CUSE**  
**FCTY Custom Setup Menu**  
CUSE Custom Setup (1 to 30)  
PAR Parameter  
iid Instance ID

**LoC**  
**FCTY Security Setting Menu**  
LoC Security Setting  
LoCo Operations Page  
PASE Password Enable  
rLoC Read Lock  
SLoC Write Security  
LoCL Locked Access Level  
roLL Rolling Password  
PASu User Password  
PASA Administrator Password

**ULoC**  
**FCTY Security Setting Menu**  
LoC Security Setting  
Code Public Key  
PASS Password

**dIAG**  
**FCTY Diagnostics Menu**  
dIAG Diagnostics  
Pn Part Number  
rEu Software Revision  
Sbl d Software Build Number  
Sn Serial Number  
DATE Date of Manufacture

**CAL**  
**FCTY Calibration Menu**  
CAL Calibration (1 to 12)  
P7u Electrical Measurement  
EL io Electrical Input Offset  
EL iS Electrical Input Slope

**RM Limit Module • Factory Page**

Display	Parameter Name Description	Range	Default	Modbus Relative Address	CIP Class Instance Attribute hex (dec)	Pro- fibus Index	Param- eter ID	Data Type and Access **
<p><i>CUSE</i> <i>FCTY</i> <b>Custom Setup Menu</b></p>								
<i>PAR</i> Par	<p><i>Custom Menu</i> <b>Parameter 1 to 30</b> Select the parameters that will appear in the Home Page when using the RUI.  The Parameter 1 value will appear in the upper display of the Home Page. It cannot be changed with the Up and Down Keys in the Home Page.  The Parameter 2 value will appear in the lower display in the Home Page. It can be changed with the Up and Down Keys, if the parameter is a writable one.  Scroll through the other Home Page parameters with the Advance Key .</p>	<p><i>none</i> None (61) <i>Pro</i> Process (75) <i>.CA</i> Calibration Off-set (1196) <i>C.F</i> Display Units (156) <i>USrr</i> Restore Settings From (227) <i>ALo</i> Low Set point (42) <i>Ah</i> High Set point (78) <i>AhY</i> Hysteresis (97) <i>LLS</i> Low Limit Set Point (181) <i>LhS</i> High Limit Set Point (182) <i>LhY</i> Hysteresis (183) <i>LSt</i> Limit Status (1668) <i>CUSE</i> Custom Menu (180)</p>	----	----	----	----	14005	uint RWES
<i>iid</i> iid	<p><i>Custom Setup (1 to 20)</i> <b>Instance ID</b> Select the instance of the parameter selected above to be displayed.</p>	1 to 24	----	----	----	----	14003	uint RWES
<p><i>LoC</i> <i>FCTY</i> <b>Security Setting Menu</b></p>								
<i>LoCo</i> LoC.o	<p><i>Security Setting</i> <b>Operations Page</b> Use to change the required security level clearance required to gain access to the Operations Page.</p>	1 to 3	2	----	----	----	----	unit RWE
<p>** R: Read, W: Write, E: EEPROM, S: User Set</p>								

RM Limit Module • Factory Page

Display	Parameter Name Description	Range	Default	Modbus Relative Address	CIP Class Instance Attribute hex (dec)	Pro- fibus Index	Param- eter ID	Data Type and Access **
<b>PAS.E</b> PAS.E	<b>Security Setting Password Enable</b> Turn Password Enable ON if a Password access feature is desired. This is in addition to Read Lock or Write Security..	<b>oFF</b> Off <b>oN</b> On	Off	----	----	----	----	----
<b>rLoC</b> rLoC	<b>Security Setting Read Lock</b> Set the read security clearance level. The user can access the selected level and all lower levels. Applies regardless of Password Enable setting. Set the Read Lock clearance level. The user can have read access to the selected level and all lower levels. If the Write Security level is higher than the Read Lock, the Read Lock level takes priority.	1 to 5	5	----	----	----	----	----
<b>SLoC</b> SLoC	<b>Security Setting Write Security</b> Set the write security clearance level. The user can access the selected level and all lower levels. Applies regardless of Password Enable setting. Set the Write Security clearance level. The user can have write access to the selected level and all lower levels. If the Write Security level is higher than the Read Lock, the Read Lock level takes priority.	0 to 5	5	----	----	----	----	----

\*\* R: Read, W: Write, E: EEPROM, S: User Set

**RM Limit Module • Factory Page**

Display	Parameter Name Description	Range	Default	Modbus Relative Address	CIP Class Instance Attribute hex (dec)	Pro- fibus Index	Param- eter ID	Data Type and Access **
<i>LoC.L</i> LoC.L	Security Setting <b>Locked Access Level</b> Determines user level menu visibility when Password is enabled. See Features section under Password Security. This setting is in addition to Read Lock and Write Security. Consider using only Locked Access Level and Set Read Lock and Write Security to 5.	1 to 5	5	----	----	----	----	----
No Display	<i>Security Setting</i> <b>Locked State</b> Current level of security	Lock (228) User (1684) Admin (1685)	----	----	----	----	3023	uint R
<i>roLL</i> roLL	Security Setting <b>Rolling Password</b> Applies if Password Enable is ON. When power is cycled a new Public Key will be displayed.	<i>oFF</i> Off <i>oN</i> On	Off	----	----	----	----	----
<i>PAS.u</i> PAS.u	Security Setting <b>User Password</b> Applies if Password Enable is ON. Used to acquire access to menus made available through the Locked Access Level setting. Do not forget the password as it is required to change Locked Access Level, Read Lock or Write Security.	10 to 999	63	----	----	----	----	----
<i>PAS.A</i> PAS.A	<i>Security Setting</i> <b>Administrator Password</b> Applies if Password Enable is ON. Used to acquire access to menus made available through the Locked Access Level setting. Do not forget the password as it is required to change Locked Access Level, Read Lock, Write Security and the ability to change the Passwords.	10 to 999	156	----	----	----	----	----

\*\* R: Read, W: Write, E: EEPROM, S: User Set

**RM Limit Module • Factory Page**

Display	Parameter Name Description	Range	Default	Modbus Relative Address	CIP Class Instance Attribute hex (dec)	Pro- fibus Index	Param- eter ID	Data Type and Access **
<p><i>ULoE</i> <i>FcLy</i> <b>Security Setting Menu</b></p>								
<i>Code</i> CodE	<p><i>Security Setting</i> <b>Public Key</b> If Rolling Password is turned ON, generates a random number when power is cycled. If Rolling Password is OFF, a fixed number will be displayed. The Public Key is only required if the assigned Password is unknown. Provide the key to the OEM or technical support to gain access.</p>	Customer Specific	0	----	----	----	----	----
<i>PASS</i> PASS	<p><i>Security Setting</i> <b>Password</b> Applies if Password Enable is set to ON. Enter the 4-digit assigned password. If unknown, contact your supervisor, the OEM or technical support to gain access.</p>	-1999 to 9999	0	----	----	----	----	----
<p><i>d.r9</i> <i>FcLy</i> <b>Diagnostics Menu</b></p>								
<i>Pn</i> Pn	<p><i>Diagnostics Menu</i> <b>Part Number</b> Display this controller's part number.</p>	24	----	----	0x65 (101) 1 9	66	1009	int RWE
<i>rEv</i> rEV	<p><i>Diagnostics Menu</i> <b>Software Revision</b> Display this controller's firmware revision number.</p>	5	----	4	0x65 (101) 1 to 5 0x11 (17)	67	1017	int R
<i>S.bLd</i> S.bLd	<p><i>Diagnostics Menu</i> <b>Software Build Number</b> Display the firmware build number.</p>	0 to 2,147,483,647	----	8	0x65 (101) 1 to 5 5	----	1005	float R
<i>Sn</i> Sn	<p><i>Diagnostics Menu</i> <b>Serial Number</b> Display the serial number.</p>	0 to 2,147,483,647	----	12	0x65 (101) 1 7	----	1032	float RWE
<p>** R: Read, W: Write, E: EEPROM, S: User Set</p>								



**RM Limit Module • Factory Page**

Display	Parameter Name Description	Range	Default	Modbus Relative Address	CIP Class Instance Attribute hex (dec)	Pro- fibus Index	Param- eter ID	Data Type and Access **
<b>dAtE</b> dAtE	Diagnostics Menu <b>Date of Manufacture</b> Display the date code.	0 to 2,147,483,647	-----	14	0x65 (101) 1 8	-----	1008	float RWE
No Dis- play	Diagnostics Menu <b>Hardware ID</b> Read the hardware ID.	23 or 116	23	0	0x65 (101) 1 1	-----	1001	signed 32-bit R
No Dis- play	<i>Diagnostics Menu</i> <b>Device Name</b> Read the device name.	EZ-ZONE RM	-----	-----	0x65 (101) 1 0x0B (11)	-----	1011	string R
No Dis- play	<i>Diagnostics Menu</i> <b>Device Status</b> Return hardware status Fail means return to factory.	OK (138) Fail (32)	-----	30	0x65 (101) 1 0x10 (16)	-----	1016	uint R
<b>Calibration Menu</b>								
<b>Mv</b> Mv	<i>Calibration Menu (1 to 12)</i> <b>Electrical Measurement</b> Read the raw electrical value for this input in the units corresponding to the Sensor Type (Setup Page, Analog Input Menu) setting.	-3.4e38 to 3.4e38		450 [offset 90]	0x68 (104) 1 to 12 0x15 (21)	-----	4021	float R
<b>ELi.o</b> ELi.o	<i>Calibration Menu (1 to 12)</i> <b>Electrical Input Offset</b> Change this value to calibrate the low end of the input range.	-1,999.000 to 9,999.000	0.0	428 [offset 90]	0x68 (104) 1 to 12 0xA (10)	-----	4010	float RWES
<b>ELi.S</b> ELi.S	<i>Calibration Menu (1 to 12)</i> <b>Electrical Input Slope</b> Adjust this value to calibrate the slope of the input value.	-1,999.000 to 9,999.000	1.0	430 [offset 90]	0x68 (104) 1 to 12 0xB (11)	-----	4011	float RWES
** R: Read, W: Write, E: EEPROM, S: User Set								

# 6

## Chapter 6: Features

<b>Saving and Restoring User Settings</b> . . . . .	<b>111</b>
<b>Module Limit</b> . . . . .	<b>111</b>
<b>Inputs</b> . . . . .	<b>112</b>
10 Point Linearization . . . . .	115
<b>Alarms</b> . . . . .	<b>116</b>
Process Alarms . . . . .	116
Alarm Set Points . . . . .	116
Alarm Hysteresis . . . . .	116
Alarm Latching . . . . .	116
Alarm Silencing . . . . .	117
Alarm Blocking . . . . .	117
<b>Using Password Security</b> . . . . .	<b>118</b>
<b>Modbus - Using Programmable Memory Blocks</b> . . . . .	<b>119</b>
<b>Software Configuration</b> . . . . .	<b>120</b>
Using EZ-ZONE Configurator Software . . . . .	120
<b>Function Block Descriptions</b> . . . . .	<b>125</b>
Action Function . . . . .	125
Alarm Function . . . . .	126
Analog Input Function . . . . .	128
Compare Function . . . . .	130
Counter Function . . . . .	132
Custom Function . . . . .	133
Diagnostic Function . . . . .	133
Digital Input/Output Function . . . . .	134
Global Function . . . . .	135
Linearization Function . . . . .	136
Logic Function . . . . .	138
Math Function . . . . .	142
Modbus® Function . . . . .	147
Output Function . . . . .	148
Security Function . . . . .	149
Timer Function . . . . .	150
Variable Function . . . . .	156

## Saving and Restoring User Settings

Recording setup and operations parameter settings for future reference is very important. If you unintentionally change these, you will need to program the correct settings back into the controller to return the equipment to operational condition.

After you program the controller and verify proper operation, use Save Settings As *USr.5* (Setup Page, Global Menu) to save the settings into either of two files in a special section of memory.

### Note:

Starting with firmware release 6, there is only one user set.

If the settings in the controller are altered and you want to return the controller to the saved values, use Restore Settings From *USr.r* (Setup Page, Global Menu) to recall the previously saved settings. A digital input or the Function Key via the Action Block can also be configured to restore parameters.

### CAUTION:

If an Action is programmed for User Set Restore, the operator may select Factory Restore and the Digital Input or Function Key may no longer be programmed for User Setting Restore.

### Note:

Restoring to factory defaults will overwrite the entirety of the module memory; this would include any customized assemblies used with any of the available communications protocols.

### Note:

Only perform the above procedure when you are sure that all the correct settings are programmed into the controller. Saving the settings overwrites any previously saved collection of settings. Be sure to document all the controller settings.

---

## Module Limit

This feature allows the user to setup a single output to reflect an energized (safe) or de-energized (tripped) state for the module. The reference to an energized or de-energized state refers to the internal coil that drives the Form A relay. When energized (safe) the contact is closed, when de-energized the contact is open. If any configured limit is tripped (process value exceeds set point or limit input has malfunctioned), the output LED assigned to serve as this function will come on. By default (factory settings), output 8 is assigned this function where any output of choice can be configured as such.

### Note:

If limit loops exist on the module that are not intended to be used immediately, the loop must be setup to avoid a trip condition. To do this simply jumper the input for the unused loops and then ensure that the set point will never be exceeded (Operations Page, Limit Menu) by the process variable.

## Inputs

### Calibration Offset

Calibration offset allows a device to compensate for an inaccurate sensor, lead resistance or other factors that affect the input value. A positive offset increases the input value, and a negative offset decreases the input value.

The input offset value can be viewed or changed with Calibration Offset `.CAL` (Operations Page, Analog Input Menu).

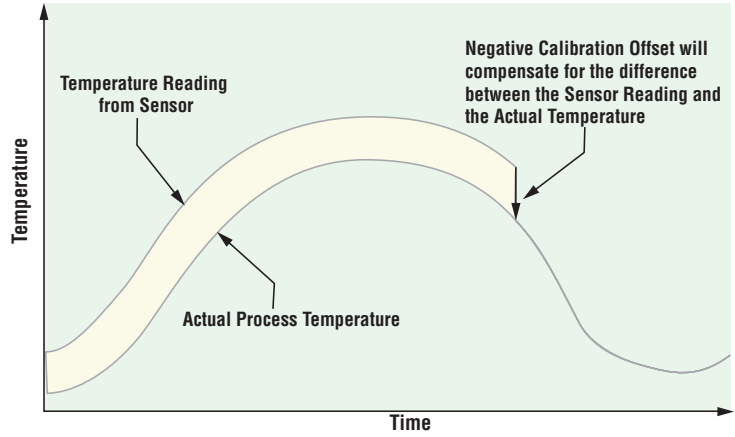

### Calibration

Before performing any calibration procedure, verify that the displayed readings are not within published specifications by inputting a known value from a precision source to the analog input. Next, subtract the displayed value with the known value and compare this difference to the published accuracy range specification for that type of input.

Use of the Calibration Offset `.CAL` parameter found in the Operations Page `OPER`, Analog Input Menu `AI`, shifts the readings across the entire displayed range by the offset value. Use this parameter to compensate for sensor error or sensor placement error. Typically this value is set to zero.

### Equipment required while performing calibration:

Obtain a precision source for millivolts, volts, milliamperes or resistance depending on the sensor type to be calibrated. Use copper wire only to connect the precision source to the controller's input. Keep leads between the precision source and controller as short as possible to minimize error. In addition, a precision volt/ohm meter capable of reading values to 4 decimal places or better is recommended. Prior to calibration, connect this volt/ohm meter to the precision source to verify accuracy.

Actual input values do NOT have to be exactly the recommended values, but it IS critical that the actual value of the signal connected to the controller be accurately known to at least four digits.

### Calibration of Analog Inputs:

To calibrate an analog input, you will need to provide a source of two electrical signals or resistance values near the extremes of the range that the application is likely to utilize. See recommended values below:

Sensor Type	Low Source	High Source
thermocouple	0.000 mV	50.000 mV
millivolts	0.000 mV	50.000 mV
volts	0.000V	10.000V
milliamps	0.000 mA	20.000 mA
100 $\Omega$ RTD	50.00 $\Omega$	350.00 $\Omega$
1,000 $\Omega$ RTD	500.00 $\Omega$	3,500.00 $\Omega$
Thermistor 5K	50.00 $\Omega$	5000.00 $\Omega$
Thermistor 10K	50.00 $\Omega$	10000.00 $\Omega$

Sensor Type	Low Source	High Source
Thermistor 20K	50.00 Ω	20000.00 Ω
Thermistor 40K	50.00 Ω	40000.00 Ω

**Note:**

The user may only calibrate one sensor type. If the calibrator interferes with open thermocouple detection, set Sensor Type *SEN* in Setup Page *SET*, Analog Input Menu *A1* to millivolt *P7U* instead of Thermocouple *TC* to avoid interference between the calibrator and open thermocouple detect circuit for the duration of the calibration process. Be sure to set sensor type back to the thermocouple type utilized.

**Follow these steps for a Thermocouple or Process Input:**

1. Disconnect the sensor from the controller.
2. Record the Calibration Offset *ICR* parameter value in the Operations Page *OPER*, Analog Input Menu *A1*, then set value to zero.
3. Wire the precision source to the appropriate controller input terminals to be calibrated. Do not have any other wires connected to the input terminals. Please refer to the Install and Wiring section of this manual for the appropriate connections.
4. Ensure the controller sensor type is programmed to the appropriate Sensor Type *SEN* to be utilized in the Setup Page *SET*, Analog Input Menu *A1*.
5. Enter Factory Page *FCTY*, Calibration Menu *CAL* via RUI or EZ-ZONE Configurator Software.
6. Select the Calibration *CAL* input instance to be calibrated. This corresponds to the analog input to be calibrated.
7. Set Electrical Input Slope *EL15* to 1.000 and Electrical Input Offset *EL10* to 0.000 (this will cancel any prior user calibration values)
8. Input a Precision Source Low value. Read Electrical Measurement value *P7U* of controller via EZ-Configurator or RUI. This will be referred to as Electrical Measured Low. Record low value \_\_\_\_\_
9. Input a Precision Source High value.
10. Read Electrical Measurement value *P7U* of controller via EZ-Configurator or RUI. This will be referred to as Electrical Measured High. Record high value \_\_\_\_\_
11. Calculated Electrical Input Slope = (Precision High - Precision Low) / (Electrical Measured High - Electrical Measured Low) Calculated Slope value \_\_\_\_\_
12. Calculated Electrical Input Offset = Precision Low - (Electrical Input Slope \* Measured Low) Calculated Offset value \_\_\_\_\_
13. Enter the calculated Electrical Input Slope *EL15* and Electrical Input Offset *EL10* into the controller.
14. Exit calibration menu.
15. Validate calibration process by utilizing a calibrator connected to the analog input.
16. Enter calibration offset as recorded in step 2 if required to compensate for sensor error.

**Follow these steps for an RTD input:**

1. Measure the low source resistance to ensure it is accurate. Connect the low source resistance to the input you are calibrating.
2. Read the value of Electrical Measurement *P7U* (Factory Page, Calibration Menu) for that input.

3. Calculate the offset value by subtracting this value from the low source resistance.
4. Set Electrical Input Offset  $EL1.0$  (Factory Page, Calibration Menu) for this input to the offset value.
5. Check the Electrical Measurement to see whether it now matches the resistance. If it doesn't match, adjust Electrical Offset again.
6. Measure the high source resistance to ensure it is accurate. Connect the high source resistance to the input.
7. Read the value of Electrical Measurement for that input.
8. Calculate the gain value by dividing the low source signal by this value.
9. Set Electrical Slope  $EL1.5$  (Factory Page, Calibration Menu) for this input to the calculated gain value.
10. Check the Electrical Measurement to see whether it now matches the signal. If it doesn't match, adjust Electrical Slope again.

Setting Electrical Input Slope  $EL1.5$  to 1.000 and Electrical Input Offset  $EL1.0$  to 0.000, restores factory calibration as shipped from factory.

---

### Filter Time Constant

Filtering smooths an input signal by applying a first-order filter time constant to the signal. Filtering the displayed value makes it easier to monitor. Filtering the signal may improve the performance of PID control in a noisy or very dynamic system.

Adjust the filter time interval with Filter Time  $F1L$  (Setup Page, Analog Input Menu). Example: With a filter value of 0.5 seconds, if the process input value instantly changes from 0 to 100 and remained at 100, the display will indicate 100 after five time constants of the filter value or 2.5 seconds.

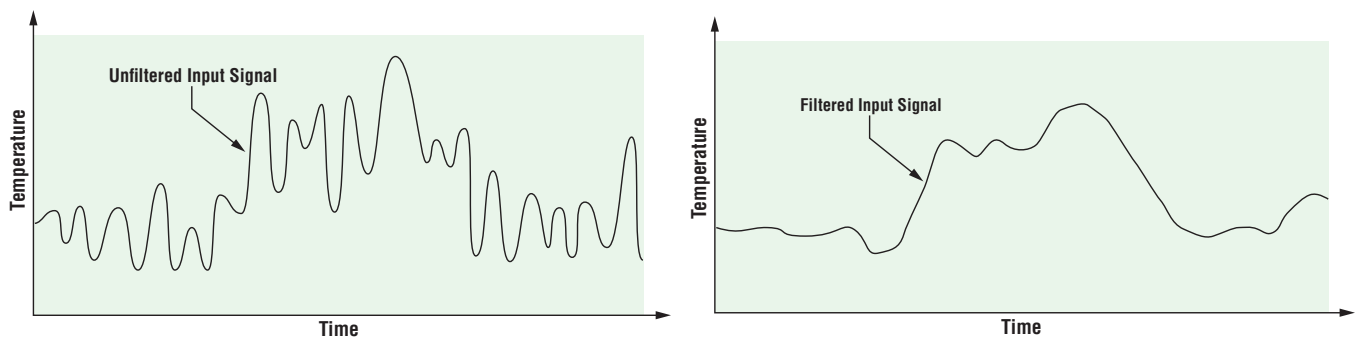

---

### Sensor Selection

You need to configure the controller to match the input device, which is normally a thermocouple, RTD or process transmitter. Select the sensor type with Sensor Type  $SEn$  (Setup Page, Analog Input Menu).

---

### Set Point Low Limit and High Limit

The controller constrains the limit set points (low and high) to a value between a Low Limit Set Point and a High Limit Set Point. Set the set point limits with Minimum Set Point  $L5P$  and Maximum Set Point  $h5P$  (Setup Page, Loop Menu).

## Scale High and Scale Low

When an analog input is selected as process voltage or process current input, you must choose the value of voltage or current to be the low and high ends. For example, when using a 4 to 20 mA input, the scale low value would be 4.00 mA and the scale high value would be 20.00 mA. Commonly used scale ranges are: 0 to 20 mA, 4 to 20 mA, 0 to 5V, 1 to 5V and 0 to 10V.

You can create a scale range representing other units for special applications. You can reverse scales from high values to low values for analog input signals that have a reversed action. For example, if 50 psi causes a 4 mA signal and 10 psi causes a 20 mA signal.

Scale low and high values do not have to match the bounds of the measurement range. These along with range low and high provide for process scaling and can include values not measurable by the controller. Regardless of scaling values, the measured value will be constrained by the electrical measurements of the hardware.

Select the low and high values with Scale Low  $S.L.O$  and Scale High  $S.H.I$ . Select the displayed range with Range Low  $r.L.O$  and Range High  $r.h.i$  (Setup Page, Analog Input Menu).

---

## Range High and Range Low

With a process input, you must choose a value to represent the low and high ends of the current or voltage range. Choosing these values allows the controller's display to be scaled into the actual working units of measurement. For example, the analog input from a humidity transmitter could represent 0 to 100 percent relative humidity as a process signal of 4 to 20 mA. Low scale would be set to 0 to represent 4 mA and high scale set to 100 to represent 20 mA. The indication on the display would then represent percent humidity and range from 0 to 100 percent with an input of 4 to 20 mA. Select the low and high values with Range Low  $r.L.O$  and Range High  $r.h.i$  (Setup Page, Analog Input Menu).

---

## 10 Point Linearization

The linearization function allows a user to re-linearize a value read from an analog input. There are 10 data points used to compensate for differences between the sensor value read (input point) and the desired value (output point). Multiple data points enable compensation for non-linear differences between the sensor readings and target process values over the thermal or process system operating range. Sensor reading differences can be caused by sensor placement, tolerances, an inaccurate sensor or lead resistance.

The user specifies the unit of measurement and then each data point by entering an input point value and a corresponding output point value. Each data point must be incrementally higher than the previous point. The linearization function will interpolate data points linearly in between specified data points.

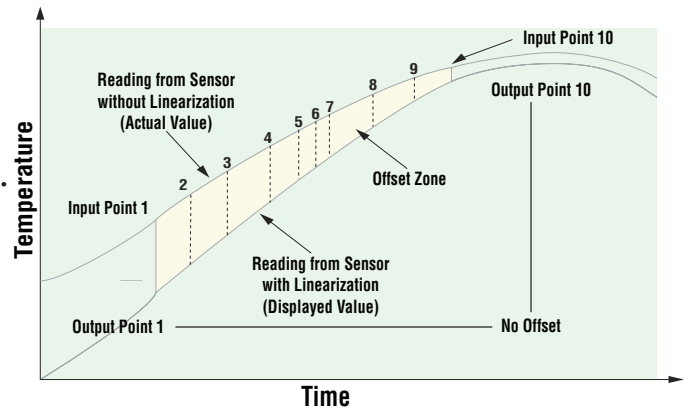

# Alarms

Alarms are activated when the output level, process value or temperature leaves a defined range. A user can configure how and when an alarm is triggered, what action it takes and whether it turns off automatically when the alarm condition is over. Configure alarm outputs in the Setup Page before setting alarm set points. Alarms do not have to be assigned to an output. Alarms can be monitored and controlled through the front panel or by using software.

## Process Alarms

A process alarm uses one or two absolute set points to define an alarm condition. Select the type with Type **ALY** (Setup Page, Alarm Menu).

## Alarm Set Points

The high set point defines the process value or temperature that will trigger a high side alarm. The low set point defines the temperature that will trigger a low side alarm. View or change alarm set points with Alarm Low **ALo** and High Set Points **Ah** (Operations Page, Alarm Menu).

## Alarm Hysteresis

An alarm state is triggered when the process value reaches the alarm high or alarm low set point. Alarm hysteresis defines how far the process must return into the normal operating range before the alarm can be cleared.

Alarm hysteresis is a zone inside each alarm set point. This zone is defined by adding the hysteresis value to the alarm low set point or subtracting the hysteresis value from the alarm high set point. View or change alarm hysteresis with Hysteresis **A.hY** (Setup Page, Alarm Menu).

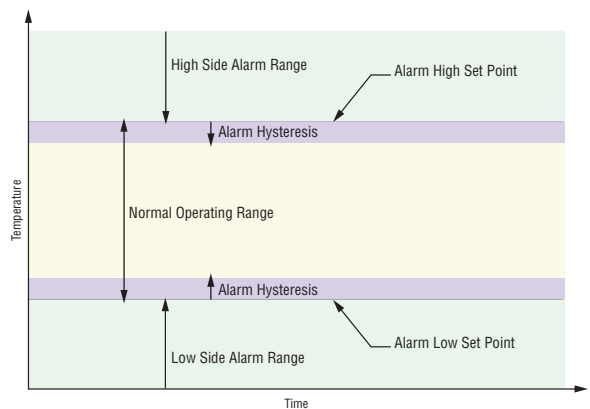

Alarm Set Points and Hysteresis

## Alarm Latching

A latched alarm will remain active after the alarm condition has passed. It can only be deactivated by the user and only when the alarm condition no longer exists.

If using an RUI an active message, such as an alarm message, will cause the display to toggle between the normal settings and the active message in the upper display and **ALtLn** in the lower display.

To clear a latched alarm:

1. Push the Advance Key **⊕** to display **ALnr** in the upper display and the message source in the lower display.
2. Use the Up **▲** or Down **▼** keys to scroll through possible responses, such as Clear **CLR** or Silence **SIL**.
3. Push the Advance **⊕** or Infinity **∞** key to execute the action.

Without an RUI, a latched alarm can be reset by cycling

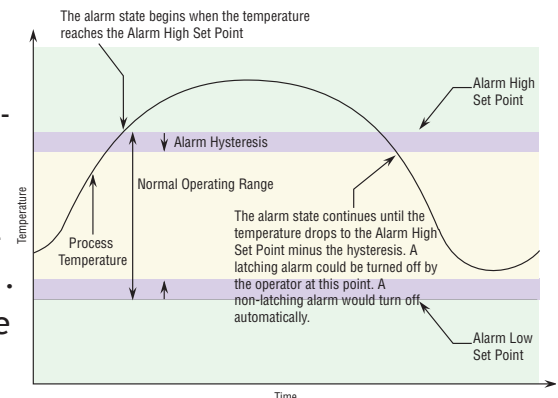

Alarm Response with Hysteresis



power to the module or configuring an Action function within the control to perform a reset. Do this by setting the Action Function to alarm and trigger the Action to occur through Source Function A. An alarm that is not latched (self-clearing) will deactivate automatically when the alarm condition has passed. Turn Latching *ALP* on or off via the Setup Page, Alarm Menu.





---

## Alarm Silencing

If silencing is on the operator can disable the alarm output while the controller is in an alarm state. The process value or temperature has to enter the normal operating range beyond the hysteresis zone to activate the alarm output function again.

If using an RUI an active message, such as an alarm message, will cause the display to toggle between the normal settings and the active message in the upper display and *ALARM* in the lower display.

*To silence an alarm:*

1. Push the Advance Key  to display *Alarm* in the upper display and the message source in the lower display.
2. Use the Up  and Down  keys to scroll through possible responses, such as Clear *CLR* or Silence *SIL*.
3. Push the Advance  or Infinity  key to execute the action.

Without an RUI, silencing an alarm can be accomplished by configuring an Action function within the control to silence the alarm. Do this by setting the Action Function to Silence and trigger the Action to occur through Source Function A. Turn Silencing *ASI* on or off via the Setup Page, Alarm Menu.

---

## Alarm Blocking

Blocking allows a system to warm up after it has been started up. With blocking on, an alarm is not triggered when the process temperature is initially lower than the low set point or higher than the high set point. The process temperature has to enter the normal operating range beyond the hysteresis zone to activate the alarm function.

Turn Blocking *ABL* on or off via the Setup Page, Alarm Menu.

## Using Password Security

It is sometimes desirable to apply a higher level of security to the control where a limited number of menus are visible and not providing access to others without a security password. Without the appropriate password those menus will remain inaccessible. If Password Enabled *PAS.E* in the Factory Page under the *LoC* Menu is set to on, an overriding Password Security will be in effect. When in effect, the only Pages that a User without a password has visibility to are defined in the Locked Access Level *LoC.L* prompt. On the other hand, a User with a password would have visibility restricted by the Read Lockout Security *rLoC*. As an example, with Password Enabled and the Locked Access Level *LoC.L* set to 1 and *rLoC* is set to 3, the available Pages for a User without a password would be limited to the Home and Factory Pages (locked level 1). If the User password is entered all pages would be accessible with the exception of the Setup Page as defined by level 3 access.

---

### How to Enable Password Security

Go to the Factory Page by holding down the Infinity  $\infty$  key and the Advance  $\odot$  key for approximately six seconds. Once there, push the Down  $\blacktriangledown$  key one time to get to the *LoC* menu. Again push the Advance  $\odot$  key until the Password Enabled *PAS.E* prompt is visible. Lastly, push either the up or down key to turn it on. Once on, 4 new prompts will appear:

1. *LoC.L*, Locked Access Level (1 to 5) corresponding to the lockout table above.
2. *rLoC*, Rolling Password will change the Customer Code every time power is cycled.
3. *PAS.u*, User Password which is needed for a User to acquire access to the control.
4. *PAS.A*, Administrator Password which is needed to acquire administrative access to the control.

The Administrator can either change the User and or the Administrator password or leave them in the default state. Once Password Security is enabled they will no longer be visible to anyone other than the Administrator. As can be seen in the formula that follows either the User or Administrator will need to know what those passwords are to acquire a higher level of access to the control. Back out of this menu by pushing the Infinity  $\infty$  key. Once out of the menu, the Password Security will be enabled.

---

### How to Acquire Access to the Control

To acquire access to any inaccessible Pages or Menus, go to the Factory Page and enter the *ULoC* menu. Once there follow the steps below:





#### Note:

If Password Security (Password Enabled *PAS.E* is On) is enabled the two prompts mentioned below in the first step will not be visible. If unknown, call the individual or company that originally setup the control.

1. Acquire either the User Password *PAS.u* or the Administrator Password *PAS.A*.
2. Push the Advance  $\odot$  key one time where the Code *CoDE* prompt will be visible.

#### Note:

- a. If the the Rolling Password is off push the Advance key one more time where the Password *PASS* prompt will be displayed. Proceed to either step 7a or 8a. Pushing the Up  $\blacktriangle$  or Down  $\blacktriangledown$  arrow keys enter either the User or Administrator Password. Once entered, push and hold the Infinity  $\infty$  key for two seconds to return to the Home Page.
- b. If the Rolling Password *rLoC* was turned on proceed on through steps 3 - 9.

3. Assuming the Code `Code` prompt (Public Key) is still visible on the face of the control simply push the Advance key  to proceed to the Password `PASS` prompt. If not, find your way back to the Factory Page as described above.
4. Execute the calculation defined below (7b or 8b) for either the User or Administrator.
5. Enter the result of the calculation in the upper display play by using the Up  and Down  arrow keys or use EZ-ZONE Configurator Software.
6. Exit the Factory Page by pushing and holding the Infinity  key for two seconds.

Formulas used by the User and the Administrator to calculate the Password follows:

Passwords equal:

7. User
  - a. If Rolling Password `roll` is Off, Password `PASS` equals User Password `PAS.u`.
  - b. If Rolling Password `roll` is On, Password `PASS` equals:  $(PAS.u \times \text{code}) \text{ Mod } 929 + 70$
8. Administrator
  - a. If Rolling Password `roll` is Off, Password `PASS` equals Administrator Password `PAS.A`.
  - b. If Rolling Password `roll` is On, Password `PASS` equals:  $(PAS.A \times \text{code}) \text{ Mod } 997 + 1000$

---

### Differences Between a User Without Password, User With Password and Administrator

- User **without** a password is restricted by the Locked Access Level `LoLL`.
- A User **with** a password is restricted by the Read Lockout Security `rLoE` never having access to the Lock Menu `LoE`.
- An Administrator is restricted according to the Read Lockout Security `rLoE` however, the Administrator has access to the Lock Menu where the Read Lockout can be changed.

---

### Modbus - Using Programmable Memory Blocks

When using the Modbus protocol, the RM features a block of addresses that can be configured by the user to provide direct access to a list of 80 user configured parameters. This allows the user easy access to this customized list by reading from or writing to a contiguous block of registers.

To acquire a better understanding of the tables found in the back of this manual (See Appendix: [Modbus Programmable Memory Blocks](#)) please read through the text below which defines the column headers used.

#### Assembly Definition Addresses

- Fixed addresses used to define the parameter that will be stored in the "Working Addresses", which may also be referred to as a pointer. The value stored in these addresses will reflect (point to) the Modbus address of a parameter within the controller.

#### Assembly Working Addresses

- Fixed addresses directly related to their associated "Assembly Definition Addresses" (e.g., Assembly Working Addresses 200 & 201 will assume the parameter pointed to by Assembly Definition Addresses 40 & 41).

When the Modbus address of a target parameter is stored in an "Assembly Definition Address" its corresponding working address will return that parameter's actual value. If it's a writable parameter, writing to its working register will change the parameter's actual value.

As an example, Modbus register 410 contains the Analog Input 1 Process Value (See Operations Page, Analog Input Menu). If the value 410 is loaded into Assembly Definition Address 91, the process value sensed by analog input 1 will also be stored in Modbus registers 250 and 251. Note that by default all registers are set to Hardware ID.

The table (See Appendix: [Modbus Programmable Memory Blocks](#)) identified as "Assembly Definition Addresses and Assembly Working Addresses" reflects the assemblies and their associated addresses.

---

## Software Configuration

To enable a user to configure the RM module using a personal computer (PC), Watlow has provided two different programs free of charge for your use.

- EZ-ZONE Configurator (text based), originally released with the EZ-ZONE family of controls.
- Composer (graphic based), released September 2014.

### Note:

RM modules must have firmware revision 9.0 and above to be used with Composer software.

Both programs can be acquired directly from the DVD (Controller Support Tools) which shipped with the controller. Insert the DVD into your DVD drive and select and then install the preferred software. Alternatively, if you are viewing this document electronically and have a connection to the internet, simply click on the link below and type either Configurator or Composer into the Keyword field and then click Search to download the software free of charge. <http://www.watlow.com/literature/software.cfm>

---

## Using EZ-ZONE Configurator Software

### Installing the Software

*To install the software:*

1. Double-click the filename " EZCv6.exe.
2. After reading the license agreement click the **I accept the terms in the License Agreement** radio button and then click on the **Next** button to proceed.
3. Once the installation is complete, click the **Finish** button.

*Starting EZ-ZONE Configurator software:*

1. Double-click the EZ-ZONE Configurator icon on the desktop.

Or



2. On the task bar, click **Start** and type ez-zone configurator.exe in the search box and then press **Enter**.
3. Once the executable is found double-click the file to run.

The first screen that will appear is shown below.

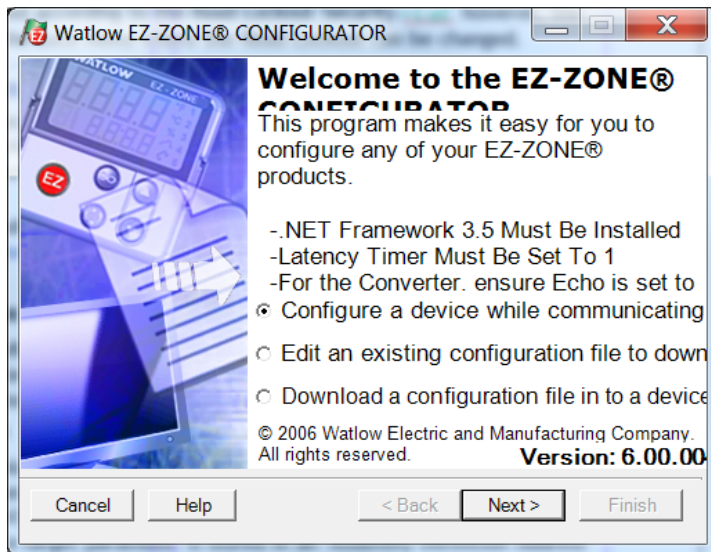

If the PC is already physically connected to the RML module click the next button to go on-line.

**Note:**

When establishing communications from PC to the RML module an interface converter will be required. The Standard Bus network uses EIA-485 as the interface. Most PCs today would require a USB to EIA-485 converter. However, some PCs may still be equipped with EIA-232 ports, therefore an EIA-232 to EIA-485 converter would be required.

As can be seen in the above screen shot the software provides the user with the option of downloading a previously saved configuration as well as the ability to create a configuration off-line to download later. The screen shots that follow will take the user on-line. After clicking the next button above, it is necessary to define the communications port on the PC to use.

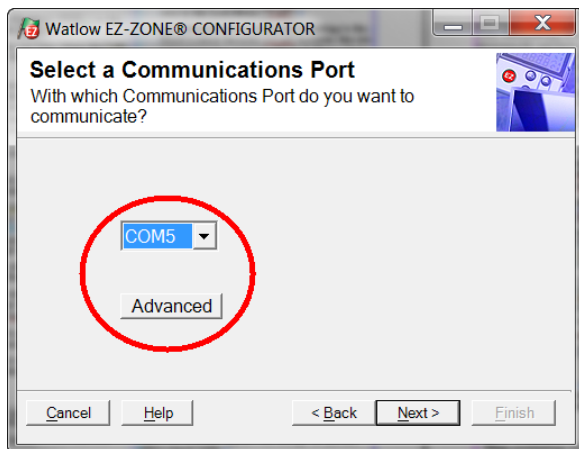

The available options allow the user to click on a drop down box to select a specific known communications port. Clicking on the Advanced button allows the user to define the number of EZ-ZONE devices to look for on the network. After clicking the Next button above, the software will then begin scanning for devices on the network as the screen shot below displays.

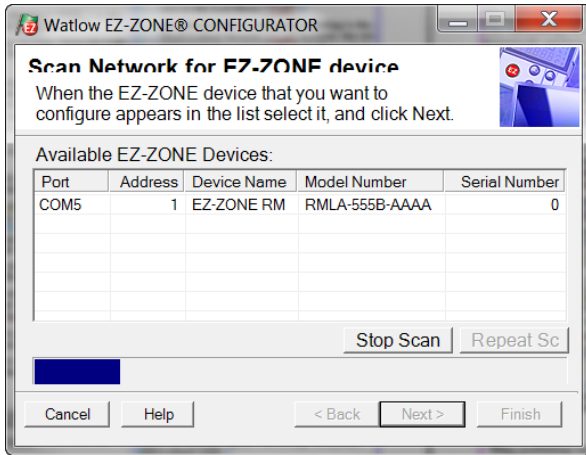

When complete the software will display all of the available devices found on the network as shown below.

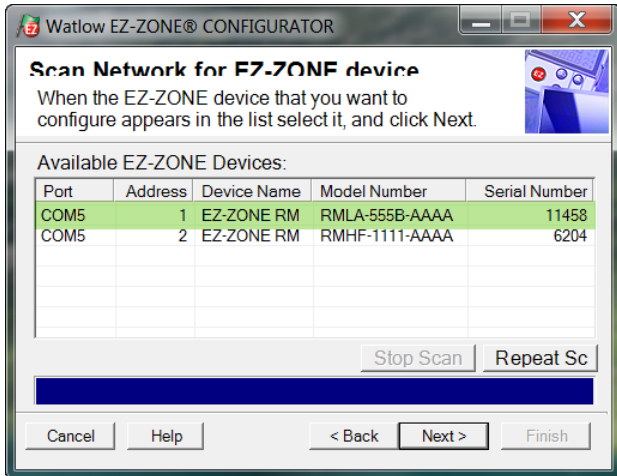

In the screen shot above the RML is shown highlighted to bring greater clarity to the module in focus. Any EZ-ZONE device on the network will appear in this window and would be available for the purpose of configuration or monitoring. After clicking on the module of choice simply click the next button once again. The screen below will appear next.

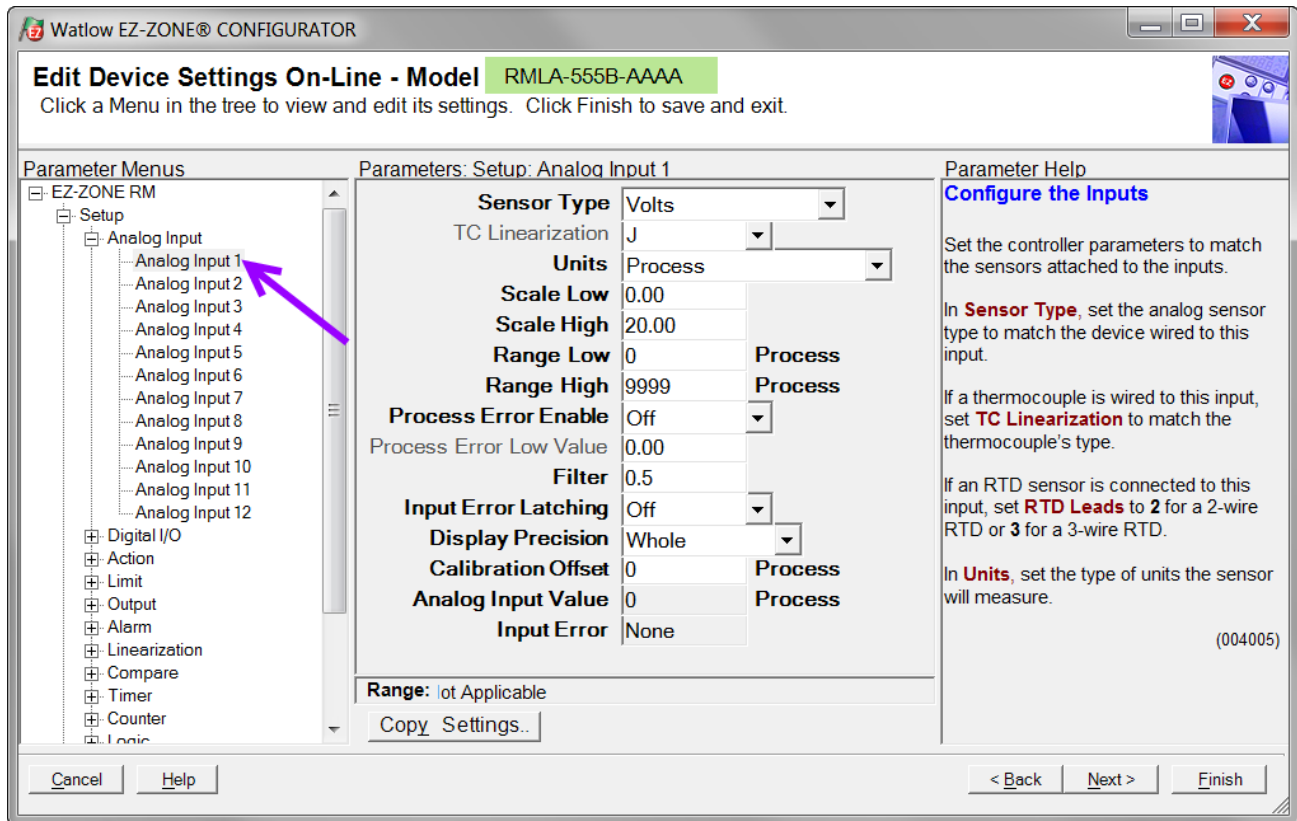

In the screen shot above notice that the device part number is clearly displayed at the top of the page (yellow highlight added for emphasis). When multiple EZ-ZONE devices are on the network it is important that the part number be noted prior to configuring so as to avoid making unwanted configuration changes to another module.

Looking closely at the left hand column (Parameter Menus) notice that it displays all of the available menus and associated parameters within this module. The menu structure as laid out within this software follows:

- Setup
- Operations
- Factory

Navigating from one menu to the next is easy and clearly visible. Simply slide the scroll bar up or down to display the menu and parameter of choice. As an alternative, clicking on the negative symbol next to Setup will collapse the Setup Menu where the Operations Menu will appear next and perhaps deliver more clarity for the area of focus by not displaying unwanted menus and parameters. Once the focus is brought to an individual parameter (single click of mouse) as is the case for Analog Input 1 in the left column, all that can be setup related to that parameter will appear in the center column. The grayed out fields in the center column simply mean that this does not apply for the type of device selected. As an example, notice that when Volts is selected, TC Linearization does not apply and is therefore grayed out. To speed up the process of configuration, notice that at the bottom of the center column there is an option to copy settings. If all Analog Inputs will be configured the same, click on "Copy Settings" where a copy from/to dialog box will appear allowing for quick duplication of all set-

tings. Notice too, that by clicking on any of those items in the center column that context sensitive help will appear for that particular item in the right hand column. Lastly, when the configuration is complete click the "Finish" button at the bottom right of the previous screen shot. The screen that follows this action can be seen below.

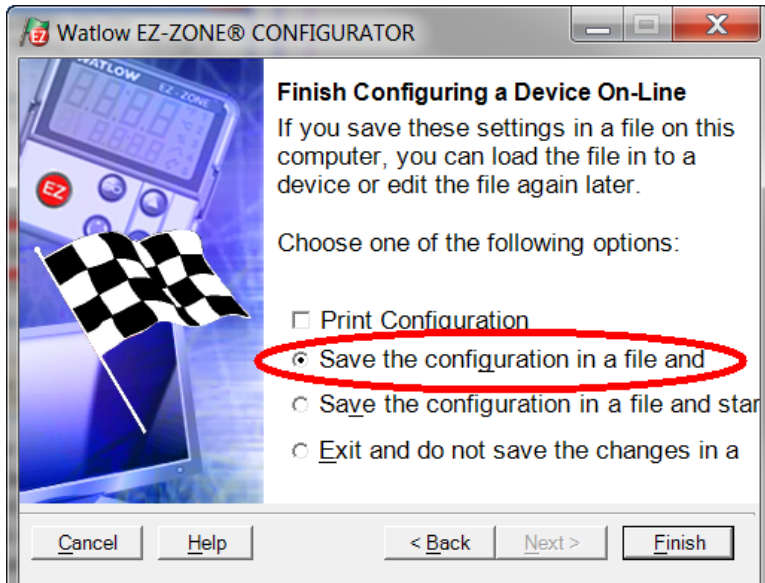

Although the RML module now contains the configuration (because the previous discussion focused on doing the configuration on-line) it is suggested that after the configuration process is completed that the user save this file on the PC for future use. If for some reason someone inadvertently changed a setting without understanding the impact it would be easy and perhaps faster to download a saved configuration back to the control versus trying to figure out what was changed. Of course, there is an option to exit without saving a copy to the local hard drive. After selecting Save above, click the "Finish" button once again. The screen below will then appear.

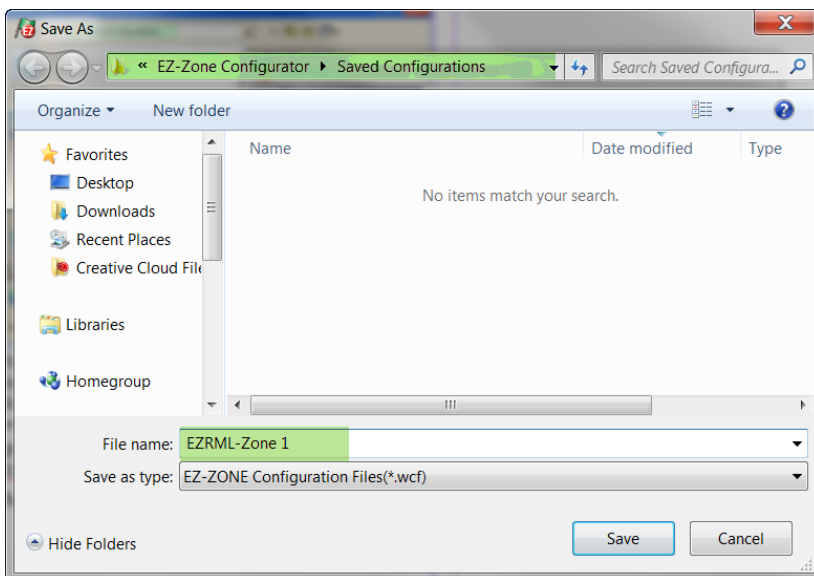

When saving the configuration note the location where the file will be placed (Saved in) and enter the file name (File name) as well. The default path for saved files follows:

\\My Documents\\Watlow\\EZ-ZONE CONFIGURATOR\\Saved Configurations The user can save the file to any folder of choice.



## Function Block Descriptions

Each of the next several pages graphically shows each of the RML function blocks. Note that as you view each, you will find text that is black and text that appears gray. The gray text represents inputs that are not currently available based on the functions defined use (red text). For instance, when the defined use of the Analog Input function is set for RTD, TC Linearization will appear gray. Ranges specified are in units or degrees F, if expressed in degrees C, the range will be smaller.

### Action Function

The Action Function will cause the action selected to occur with in the module where the action function resides when Source Function A = ON and Active Level = High. Based on a given input (Digital I/O, Event output, Logic function, etc..) the Action function can cause other functions to occur. To name a few, starting and stopping a profile, silencing alarms, turn control loops off and placing alarms in non-alarm state.

#### Note:

Action Function selection is module type and part number dependant.

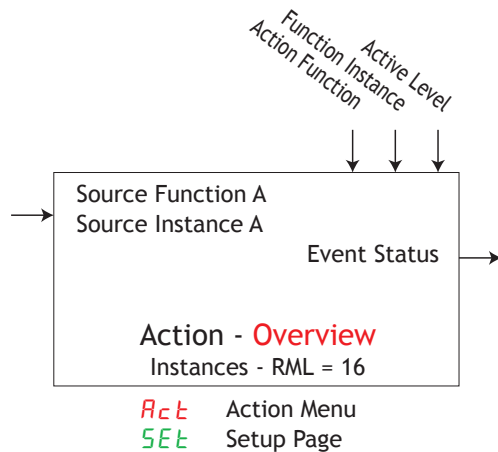

Parameter Name [Parameter ID] : Range or Choices	
<i>Fn</i>	Action Function [10003] : None, User Set Restore, Alarm, Silence Alarms, Control Loops Off and Alarms to Non-alarm State, Force Alarm to Occur
<i>Fi</i>	Function Instance [10004] : 0 to 25
<i>SFnA</i>	Source Function A [10006] : None, Alarm, Compare, Counter, Digital I/O, Profile Event Out A to H, Function Key, Limit, Logic, Timer, Variable, Heater Error
<i>SiA</i>	Source Instance A [10002] : 1 to 250
<i>SZA</i>	Source Zone A [10007] : 0 to 24
<i>LEu</i>	Active Level [10001] : High, Low

*Act* Action Menu  
*oPEr* Operations Page

<i>E. iS</i>	Event Status [10005] : On, Off
--------------	--------------------------------

## Alarm Function

Alarms are activated when the output level, process value or temperature leaves a defined range. A user can configure how and when an alarm is triggered, what action it takes and whether it turns off automatically when the alarm condition is over.

Configure alarm outputs in the Setup Page before setting alarm set points. Alarms do not have to be assigned to an output. Alarms can be monitored and controlled through the front panel or by using software.

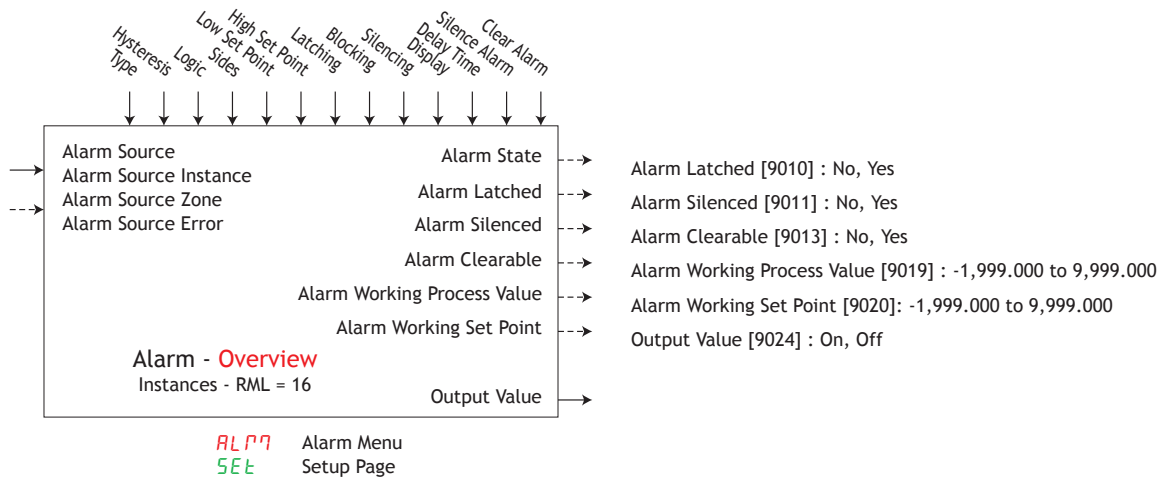

Parameter Name [Parameter ID] : Range or Choices	
<b>ALY</b>	Type [9015] : Off, Process
<b>SrA</b>	Alarm Source [9017] : None, Analog Input, Current, Power, Linearization, Math, Process Value, Variable, Current Read, Wattage, Load Voltage, Load Load Resistance
<b>.sA</b>	Alarm Source Instance [9018] : 1 to 250
<b>SzA</b>	Alarm Source Zone [9025] : 0 to 24
<b>LooP</b>	Control Loop [9023] : 1 to 250
<b>AHy</b>	Hysteresis [9003] : 0.001 to 9,999.000
<b>ALG</b>	Logic [9005] : Close on Alarm, Open on Alarm
<b>ASd</b>	Sides [9004] : Both, High, Low
<b>ALo</b>	Low Set Point [9002] : -1,999.000 to 9,999.000
<b>Ah i</b>	High Set Point [9001] : -1,999.000 to 9,999.000
<b>LAk</b>	Latching [9007] : Non-Latching, Latching
<b>AbL</b>	Blocking [9008] : Off, Startup, Set Point, Both
<b>AS i</b>	Silencing [9006] : Off, On
<b>AdSP</b>	Display [9016] : Off, On
<b>AdL</b>	Delay Time [9021] : 0 to 9,999 seconds
<b>ALCr</b>	Clear Alarm [9026] : Ignore, Clear
<b>AS ir</b>	Silence Alarm [9027] : Ignore, Silence Alarms
<b>ASk</b>	Alarm State [9009] : Startup, None, Blocked, Alarm Low, Alarm High, Error

**ALM** Alarm Menu  
**oPEr** Operations Page

<b>ALo</b>	Low Set Point [9002] : -1,999.000 to 9,999.000
<b>Ah i</b>	High Set Point [9001] : -1,999.000 to 9,999.000
<b>ALCr</b>	Clear Alarm [9026] : Ignore, Clear
<b>AS ir</b>	Silence Alarm [9027] : Ignore, Silence Alarms
<b>ASk</b>	Alarm State [9009] : Startup, None, Blocked, Alarm Low, Alarm High, Error

## Alarm (cont.)

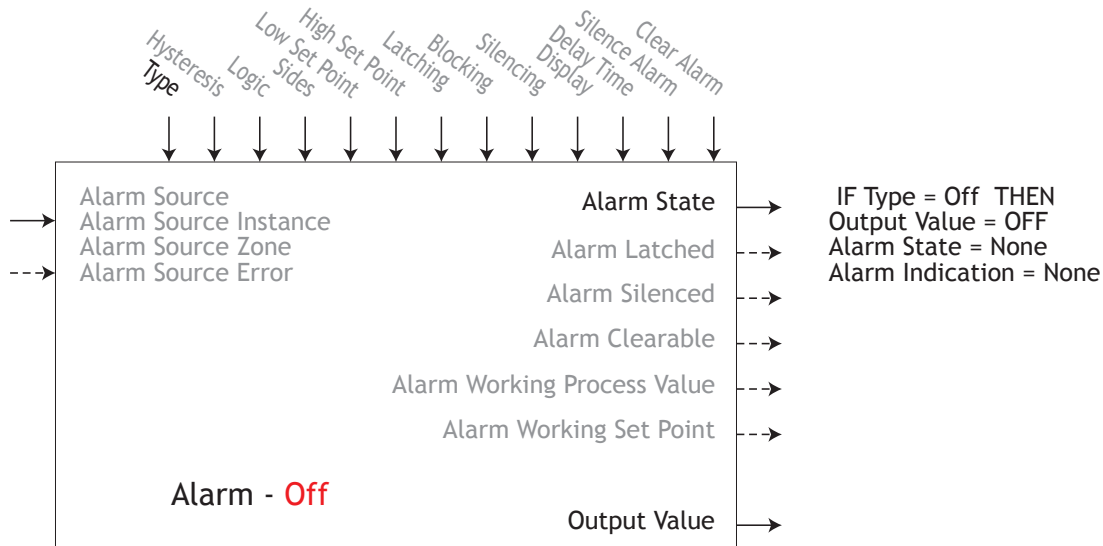

When function = Off THEN  
 Output Value = OFF  
 Alarm State = None  
 Alarm Indication = None

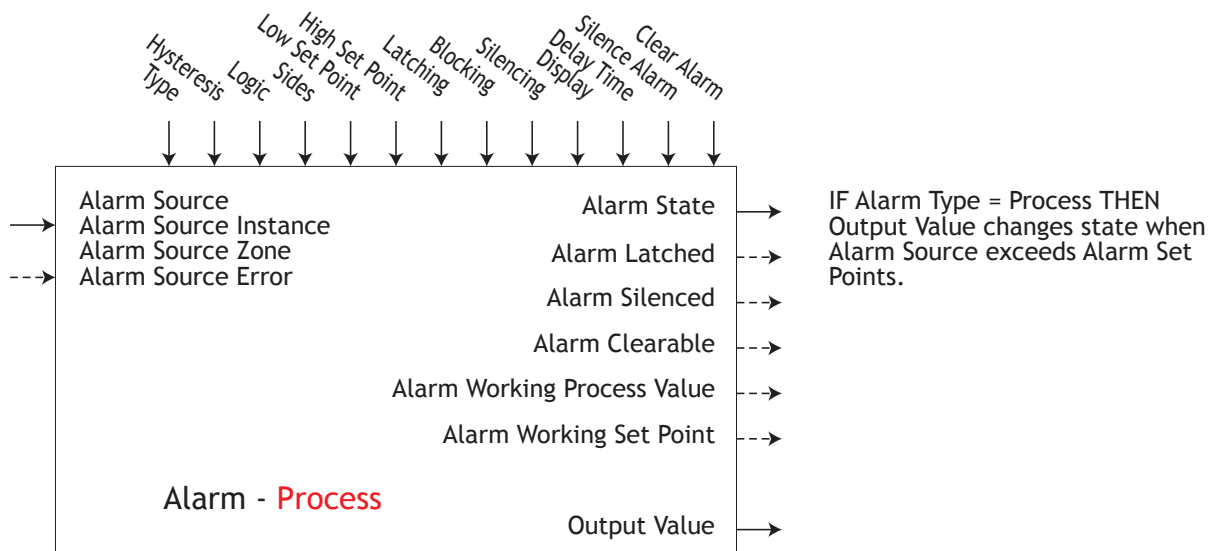

When function = Process THEN  
 Output Value = True when Alarm Source <= Low Set Point or  
 >= High Set Point

# Analog Input Function

## Note:

This function configures and connects physical inputs to internal functions. Configure the sensor type to match what is connected. For process inputs such as potentiometer, voltage, or milliampere, set the electrical span using scale low/high and engineering representation range using range low/high. Apply the corresponding units of measure.

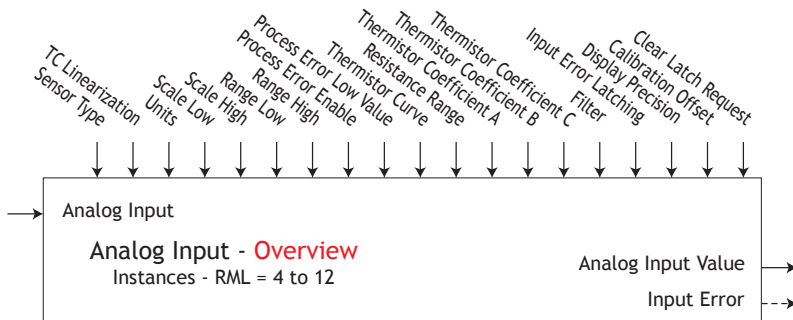

**A** : Analog Input Menu  
**SEt** Setup Page

Parameter Name [Parameter ID] : Range or Choices	
<b>SEn</b>	Sensor Type [4005] : Off, Thermocouple, Millivolts, Volts, Milliamps, RTD 100 Ohm, RTD 1000 Ohm, 1K Potentiometer, Thermistor (optional)
<b>L in</b>	TC Linearization [4006] : B, C, D, E, F, J, K, N, R, S, T
<b>Un it</b>	Units [4042] : Absolute Temperature, Power, Process, Relative Humidity
<b>SLo</b>	Scale Low [4015] : -100.00 to 1000.00
<b>SHi</b>	Scale High [4016] : -100.00 to 1000.00
<b>rLo</b>	Range Low [4017] : -1,999.000 to 9,999.000
<b>rHi</b>	Range High [4018] : -1,999.000 to 9,999.000
<b>PEE</b>	Process Error Enable [4030] : Off, Low
<b>PEL</b>	Process Error Low Value [4031] : -100.00 to 1,000.00
<b>EE</b>	Thermistor Curve [4038] : Curve A, Curve B, Curve C, Custom
<b>CoA</b>	Thermistor Coefficient A [4039] : -1,999.000 to 9,999.000
<b>CoB</b>	Thermistor Coefficient B [4040] : -1,999.000 to 9,999.000
<b>CoC</b>	Thermistor Coefficient C [4041] : -1,999.000 to 9,999.000
<b>r.r</b>	Resistance Range [4037] : 5k, 10k, 20k, 40k
<b>FiL</b>	Filter [4014] : 0.0 to 60.0 seconds
<b>iEr</b>	Input Error Latching [4028] : Off, On
<b>dEE</b>	Display Precision [4020] : Whole, Tenths, Hundredths, Thousandths
<b>iCo</b>	Calibration Offset [4012] : -1,999.000 to 9,999.000
<b>A in</b>	Analog Input Value [4001] : -1,999.000 to 9,999.000
<b>iEr</b>	Input Error [4002] : None, Open, Shorted, Measurement Error, Bad Cal Data, Ambient Error, RTD Error, Fail, Not Sourced

**A** : Analog Input Menu  
**oPEr** Operations Page

<b>A in</b>	Analog Input Value [4001] : -1,999.000 to 9,999.000
<b>iEr</b>	Input Error [4002] : None, Open, Shorted, Measurement Error, Bad Cal Data, Ambient Error, RTD Error, Fail, Not Sourced
<b>iCo</b>	Calibration Offset [4012] : -1,999.000 to 9,999.000

Clear Latch Request [4029] : Clear, Ignore

# Analog Input (cont.)

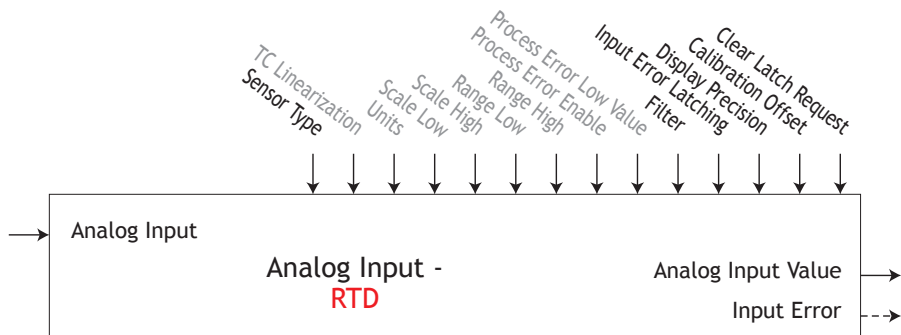
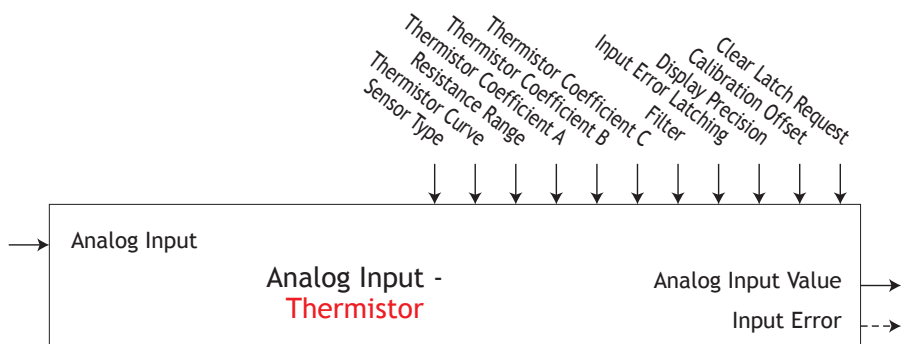
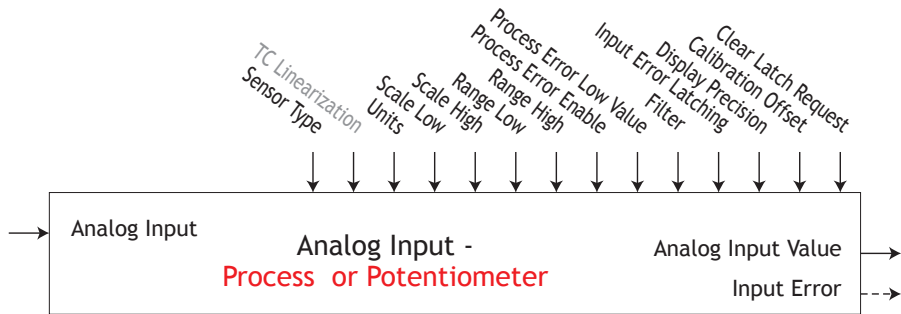
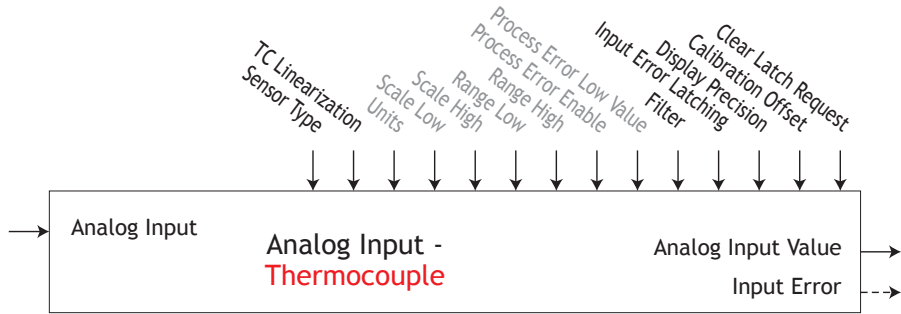
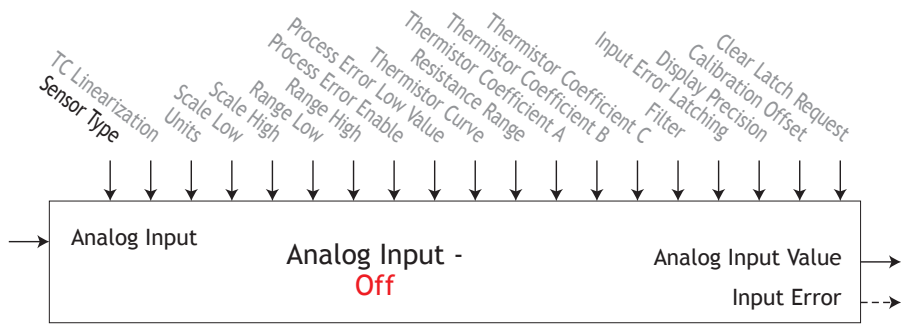

## Compare Function

Use the compare function to compare two analog values (A and B) for a condition such as are they equal. If the compare condition is met, the output turns on.

The tolerance is expressed in the same units as Source A and Requires Source A and Source B to be without errors for function to work.

Error [28013] : None, Open, Shorted, Measurement Error, Bad Cal Data, Ambient Error, RTD Error, Fail, Math Error, Not Sourced, Stale

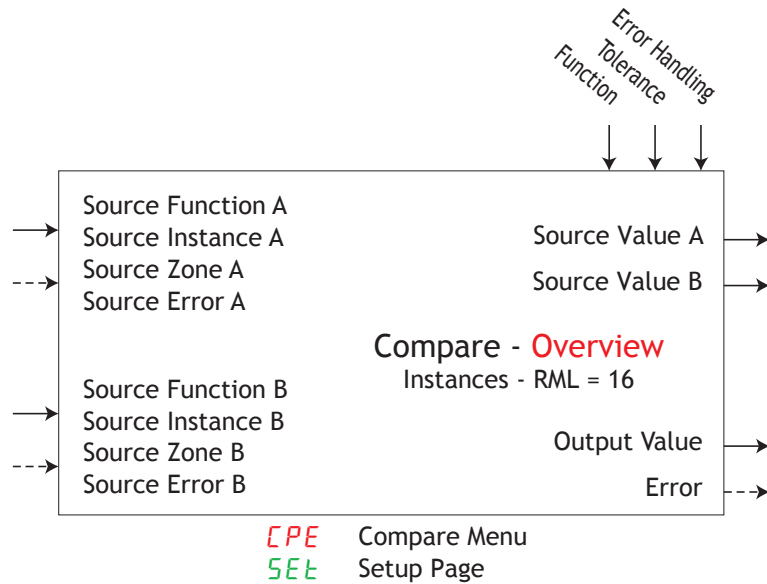

Parameter Name [Parameter ID] : Range or Choices	
<i>Fn</i>	Function [28009] : Off, Greater Than, Less Than, Equal To, Not Equal To, Greater or Equal, Less or Equal
<i>tol</i>	Tolerance [28011] : 0.0 to 9,999.000 units or F
<i>SFnA</i>	Source Function A [28001] : None, Analog Input, Current, Cool Power, Heat Power, Power, Linearization, Math, Process Value, Set Point Closed, Set Point Open, Variable, Wattage, Load Voltage, Load Resistance
<i>SiA</i>	Source Instance A [28003] : 1 to 250
<i>SzA</i>	Source Zone A [28005] : 0 to 24
<i>SFnB</i>	Source Function B [28002] : None, Analog Input, Current, Cool Power, Heat Power, Power, Linearization, Math, Process Value, Set Point Closed, Set Point Open, Variable, Wattage, Load Voltage, Load Resistance
<i>SiB</i>	Source Instance B [28004] : 1 to 250
<i>SzB</i>	Source Zone B [28006] : 0 to 24
<i>Erh</i>	Error Handling [28012] : False Bad, False Good, True Bad, True Good

*CPE* Compare Menu  
*oPEr* Operations Page

<i>SuA</i>	Source Value A [28007] : -1,999.000 to 9,999.000 units or F
<i>SuB</i>	Source Value B [28008] : -1,999.000 to 9,999.000 units or F
<i>ou</i>	Output Value [28010] : Off, On

## Compare (cont.)

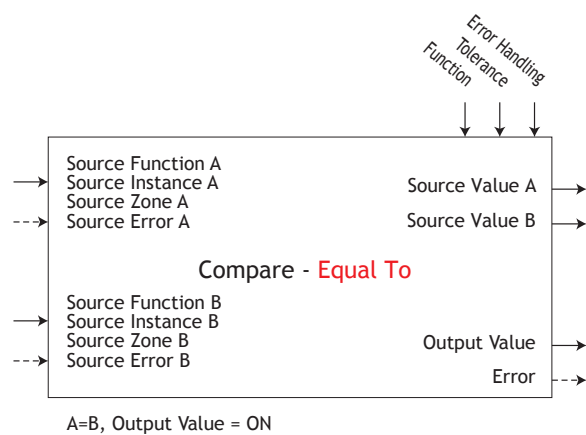
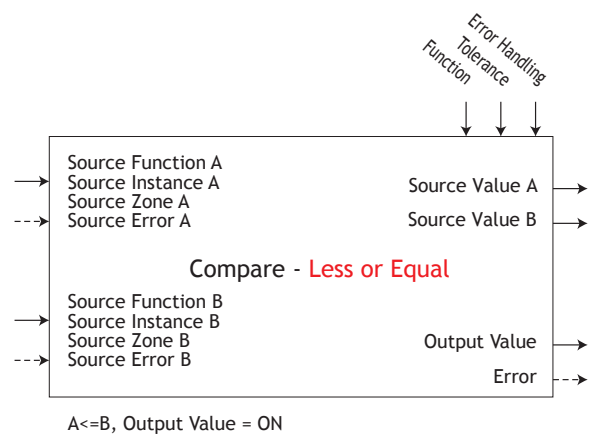
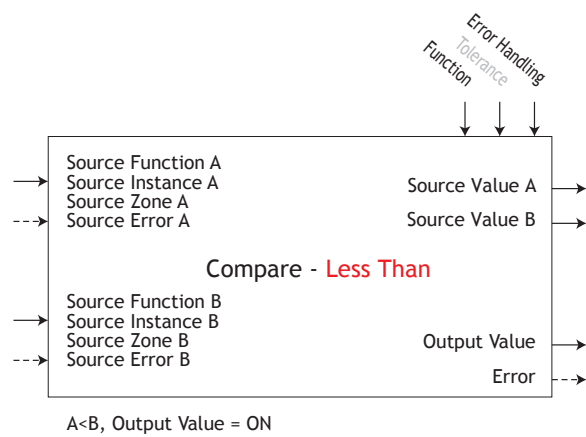
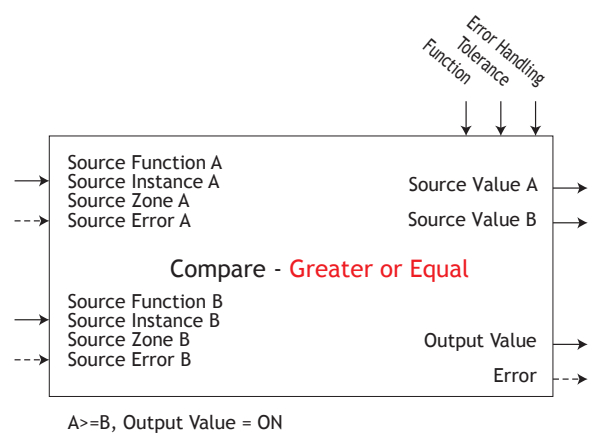
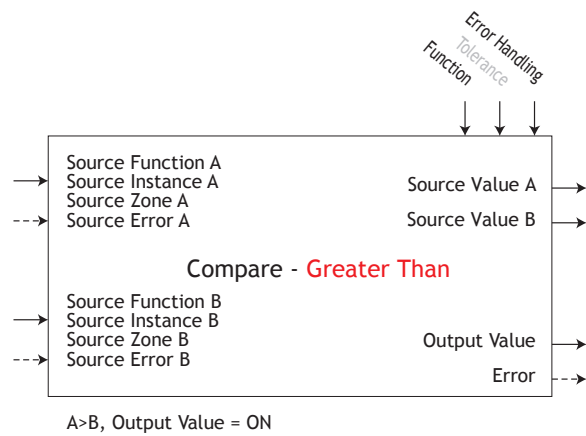
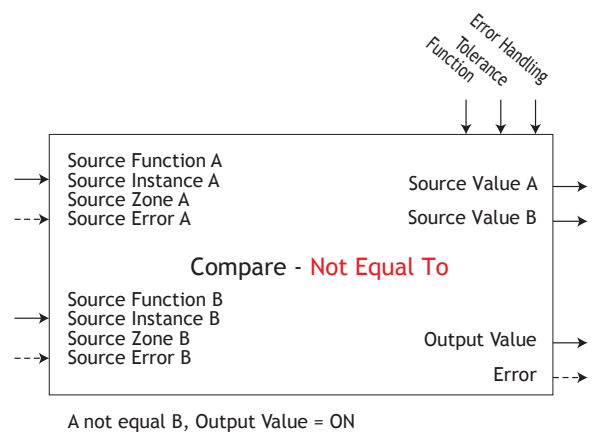
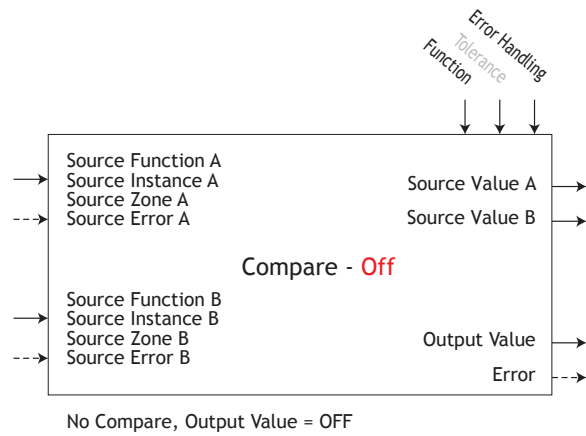

## Counter Function

Counters increment up or down from a preset value. When the count is equal to the target, the output value will be active.

- Function selects whether the counter increments or decrements the count value. Decrementing to 0 returns 9,999; incrementing to 9,999 returns 0.
- Source Function A selects which type of function increments the Count.
- Source Instance A and Source Zone A select which source to use.
- Count Active Level selects which state increments the Count.
- Source Function B selects which type of function resets the Count to the Load Value .
- Source Instance B and Source Zone B selects which source to use.
- Reset Active Level selects which state resets the Count.
- Load Value sets the counter's initial value. Count is set to this value each time the controller is powered up and each time the counter is reset.
- Target Value sets the value at which the output turns on.
- Latching sets the behavior for the output when Count exceeds the Target Value.
- Error [30016] : None, Open, Shorted, Measurement Error, Bad Cal Data, Ambient Error, RTD Error, Fail, Math Error, Not Sourced, Stale

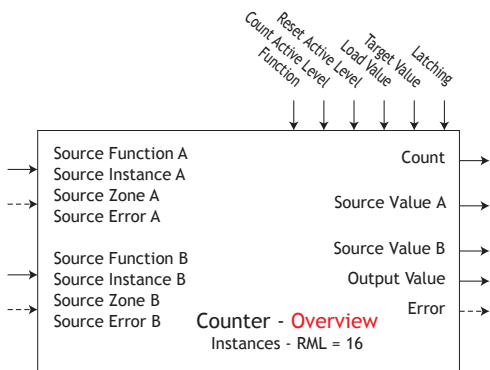

**Ctrl** Counter Menu  
**SEt** Setup Page

Parameter Name [Parameter ID] : Range or Choices	
<b>Fn</b>	Function [30009] : Up, Down
<b>SFnA</b>	Source Function A [30001] : None, Alarm, Compare, Counter, Digital I/O, Profile Event Out A to H, Function Key, Logic, Timer, Variable, Heater Error
<b>SiA</b>	Source Instance A [30003] : 1 to 250
<b>SzA</b>	Source Zone A [30005] : 0 to 24
<b>SASL</b>	Count Active Level [30011] : High, Low, Both
<b>SFnB</b>	Source Function B [30002] : None, Alarm, Compare, Counter, Digital I/O, Profile Event Out A to H, Function Key, Logic, Timer, Variable, Heater Error
<b>SiB</b>	Source Instance B [30004] : 1 to 250
<b>SzB</b>	Source Zone B [30006] : 0 to 24
<b>SASB</b>	Reset Active Level [30012] : High, Low, Both
<b>Load</b>	Load Value [30013] : 0 to 9,999
<b>Trgt</b>	Target Value [30014] : 0 to 9,999
<b>Latch</b>	Latching [30017] : No, Yes

**Ctrl** Counter Menu  
**oPEr** Operations Page

<b>Cnt</b>	Count [30015] : 0 to 9,999
<b>SuA</b>	Source Value A [30007] : Off, On
<b>SuB</b>	Source Value B [30008] : Off, On
<b>oV</b>	Output Value [30010] : Off, On



## Custom Function

Use custom menu to set the user defined parameters to display at the Home Page of an RUI/ Gateway.

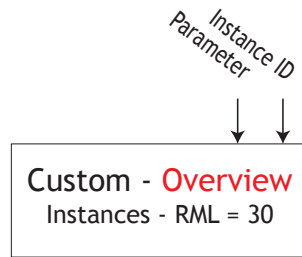

*CUSE* Custom Menu  
*FACT* Factory Page

Parameter Name [Parameter ID] : Range or Choices	
<i>PAR</i>	Parameter [14005] : None, Process, Calibration Offset, Display Units, User Settings Restore, Alarm Low Set Point, Alarm High Set Point, Alarm Hysteresis, Custom, Limit Low Set Point, Limit High Set Point, Limit Hysteresis, Limit Status
<i>IID</i>	Instance ID [14003] : 1 to 24

## Diagnostic Function

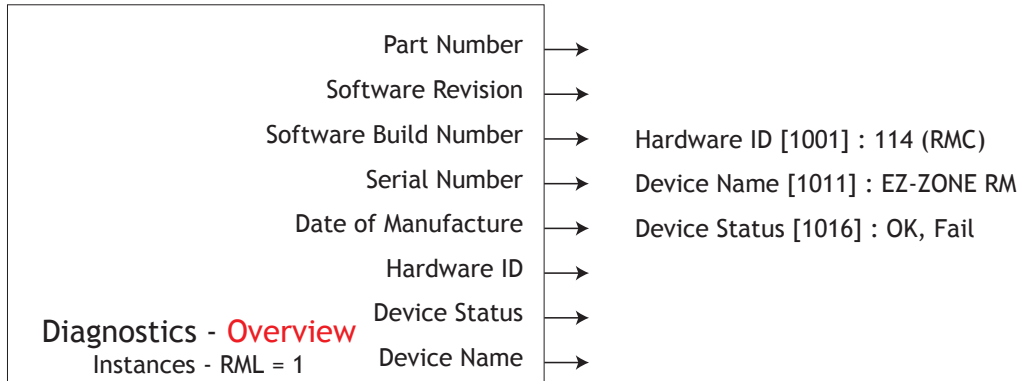

*DIAG* Diagnostics Menu  
*FACT* Factory Page

Parameter Name [Parameter ID] : Range or Choices	
<i>Pn</i>	Part Number [1009] :
<i>REU</i>	Software Revision [1003] : 9.00, ...
<i>SBLD</i>	Software Build Number [1005] :
<i>SN</i>	Serial Number [1007] : xxxxxx
<i>DATE</i>	Date of Manufacture [1008] : YWW

## Digital Input/Output Function

The Output Value is determined by Function connection and Direction.

- Error [6015] : None, Open, Shorted, Measurement Error, Bad Cal Data, Ambient Error, RTD Error, Fail, Math Error, Not Sourced, Stale

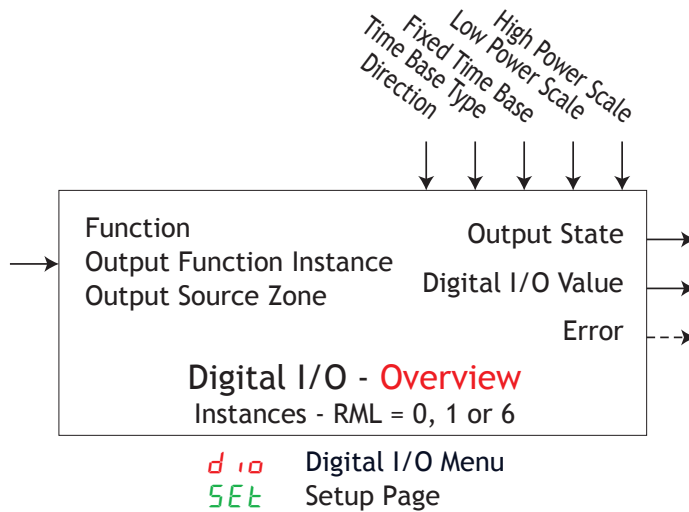

Parameter Name [Parameter ID] : Range or Choices	
<i>d i r</i>	Direction [6001] : Output, Input Voltage, Input Dry Contact
<i>F n</i>	Function [6005] : Off, Analog Input, Alarm, Cool Power, Heat Power, Compare, Counter, Digital I/O, Profile Event Out A to H, Function Key, Logic, Linearization, Math, Process Value, Special Function Output 1 to 4, Timer, Variable
<i>F i</i>	Output Function Instance [6006] : 1 to 24
<i>S Z A</i>	Output Source Zone [6012] : 0 to 16
<i>a [ t</i>	Time Base Type [6002] : Fixed Time Base, Variable Time Base
<i>a t b</i>	Fixed Time Base [6003] : 0.1 to 60.0 seconds
<i>a L o</i>	Low Power Scale [6009] : 0.0 to 100.0 %
<i>a h i</i>	High Power Scale [6010] : 0.0 to 100.0 %

*d i o* Digital I/O Menu  
*o P E r* Operations Page

<i>d i S</i>	Input State [6011] : On, Off
<i>d o S</i>	Output State [6007] : On, Off

## Digital Input/Output (cont.)

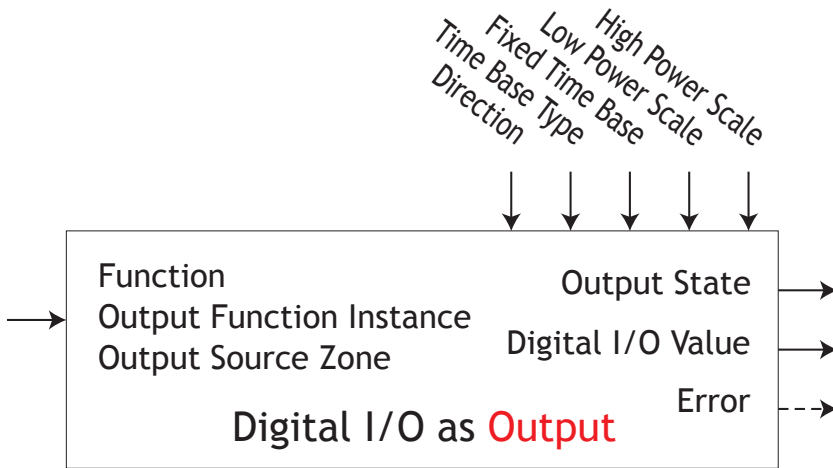
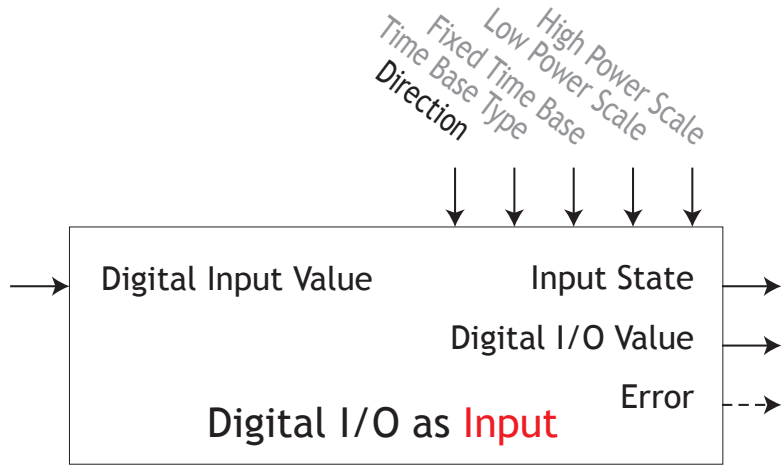

## Global Function

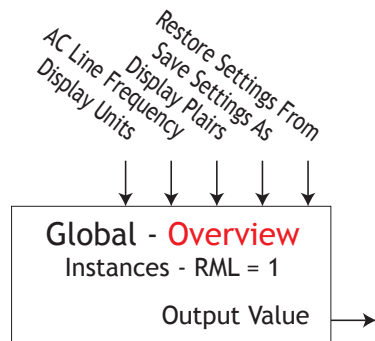

9L6L Global Menu  
5E6 Setup Page

Parameter Name [Parameter ID] : Range or Choices	
<span style="color: green;">C_F</span>	Display Units [3005] : F, C
<span style="color: green;">ACLF</span>	AC Line Frequency [1034] : 50 Hz, 60 Hz
<span style="color: green;">dPr5</span>	Display Pairs [3028] : 1 to 15
<span style="color: green;">USr.5</span>	Save Settings As [1014] : None, User Set 1
<span style="color: green;">USr.r</span>	Restore Settings From [1013] : None, User Set 1, Factory

# Linearization Function

This function will take an analog Source A and re-linearize using a 10-point offset, then add Offset and produce an Output Value.

- Error [34028]: None, Open, Shorted, Measurement Error, Bad Cal Data, Ambient Error, RTD Error, Fail, Math Error, Not Sourced, Stale

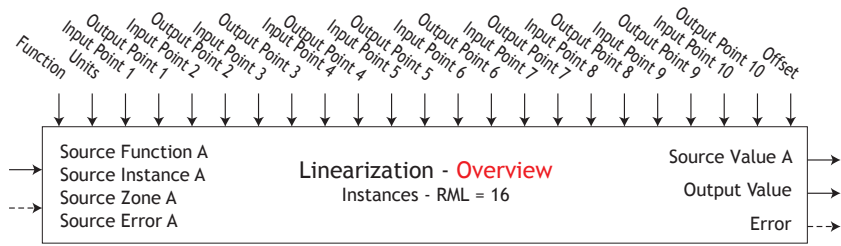

*Lnr* Linearization Menu  
*SEt* Setup Page

Parameter Name [Parameter ID] : Range or Choices	
<i>F<sub>n</sub></i>	Function [34005] : Off, Interpolated, Stepped
<i>SFnA</i>	Source Function A [34001] : None, Analog Input, Current, Cool Power, Heat Power, Power, Linearization, Math, Process Value, Set Point Closed, Set Point Open, Variable
<i>S<sub>IA</sub></i>	Source Instance A [34002] : 1 to 24
<i>S<sub>ZA</sub></i>	Source Zone A [34003] : 0 to 16
<i>Un<sub>it</sub></i>	Units [34029] : Source, None, Absolute Temperature, Relative Temperature, Power, Process, Relative Humidity
<i>iP<sub>1</sub></i>	Input Point 1 [34008] : -1,999.000 to 9,999.000
<i>oP<sub>1</sub></i>	Output Point 1 [34018] : -1,999.000 to 9,999.000
<i>iP<sub>2</sub></i>	Input Point 2 [34009] : -1,999.000 to 9,999.000
<i>oP<sub>2</sub></i>	Output Point 2 [34019] : -1,999.000 to 9,999.000
<i>iP<sub>3</sub></i>	Input Point 3 [34010] : -1,999.000 to 9,999.000
<i>oP<sub>3</sub></i>	Output Point 3 [34020] : -1,999.000 to 9,999.000
<i>iP<sub>4</sub></i>	Input Point 4 [34011] : -1,999.000 to 9,999.000
<i>oP<sub>4</sub></i>	Output Point 4 [34021] : -1,999.000 to 9,999.000
<i>iP<sub>5</sub></i>	Input Point 5 [34012] : -1,999.000 to 9,999.000
<i>oP<sub>5</sub></i>	Output Point 5 [34022] : -1,999.000 to 9,999.000
<i>iP<sub>6</sub></i>	Input Point 6 [34013] : -1,999.000 to 9,999.000
<i>oP<sub>6</sub></i>	Output Point 6 [34023] : -1,999.000 to 9,999.000
<i>iP<sub>7</sub></i>	Input Point 7 [34014] : -1,999.000 to 9,999.000
<i>oP<sub>7</sub></i>	Output Point 7 [34024] : -1,999.000 to 9,999.000
<i>iP<sub>8</sub></i>	Input Point 8 [34015] : -1,999.000 to 9,999.000
<i>oP<sub>8</sub></i>	Output Point 8 [34025] : -1,999.000 to 9,999.000
<i>iP<sub>9</sub></i>	Input Point 9 [34016] : -1,999.000 to 9,999.000
<i>oP<sub>9</sub></i>	Output Point 9 [34026] : -1,999.000 to 9,999.000
<i>iP<sub>10</sub></i>	Input Point 10 [34017] : -1,999.000 to 9,999.000
<i>oP<sub>10</sub></i>	Output Point 10 [34027] : -1,999.000 to 9,999.000

*Lnr* Linearization Menu  
*oPEr* Operations Page

<i>S<sub>uA</sub></i>	Source Value A [34004] : -1,999.000 to 9,999.000
<i>oFSt</i>	Offset [34006] : -1,999.000 to 9,999.000
<i>o<sub>u</sub></i>	Output Value [34007] : -1,999.000 to 9,999.000

## Linearization (cont.)

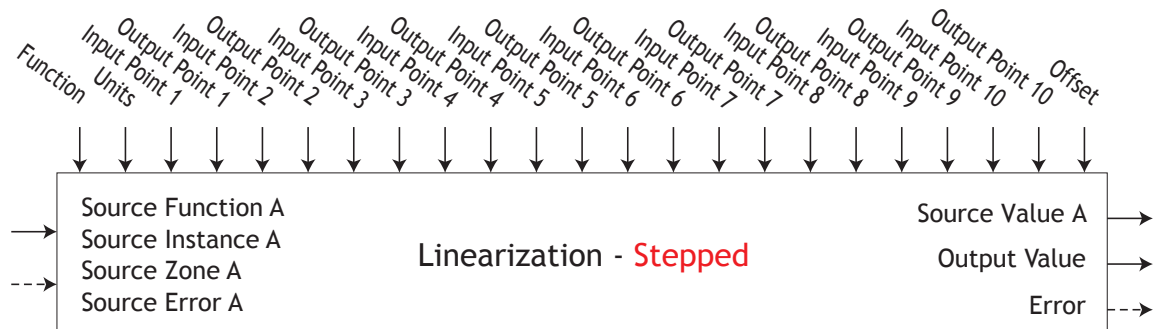
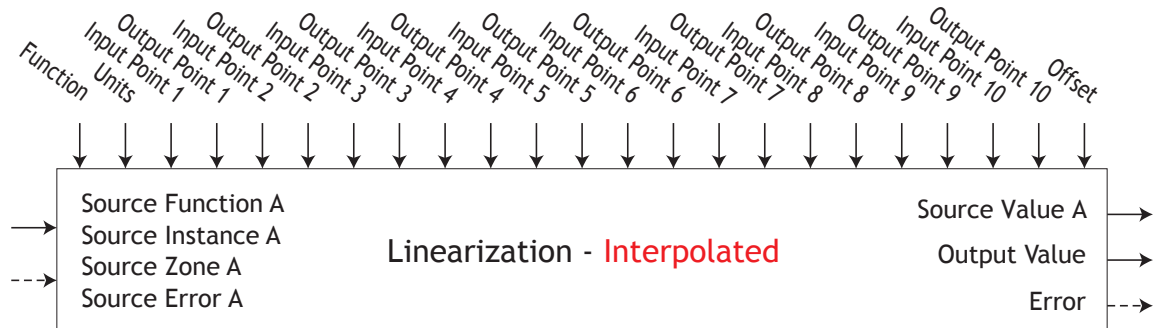
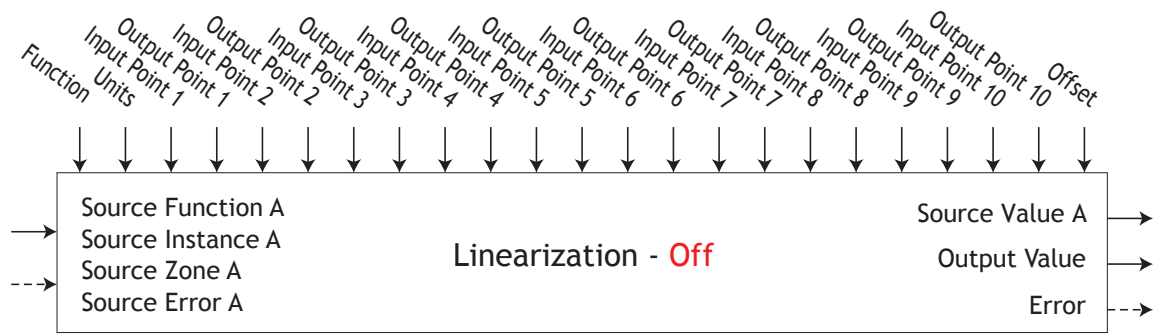

# Logic Function

- Error [27036] : None, Open, Shorted, Measurement Error, Bad Cal Data, Ambient Error, RTD Error, Fail, Math Error, Not Sourced, Stale

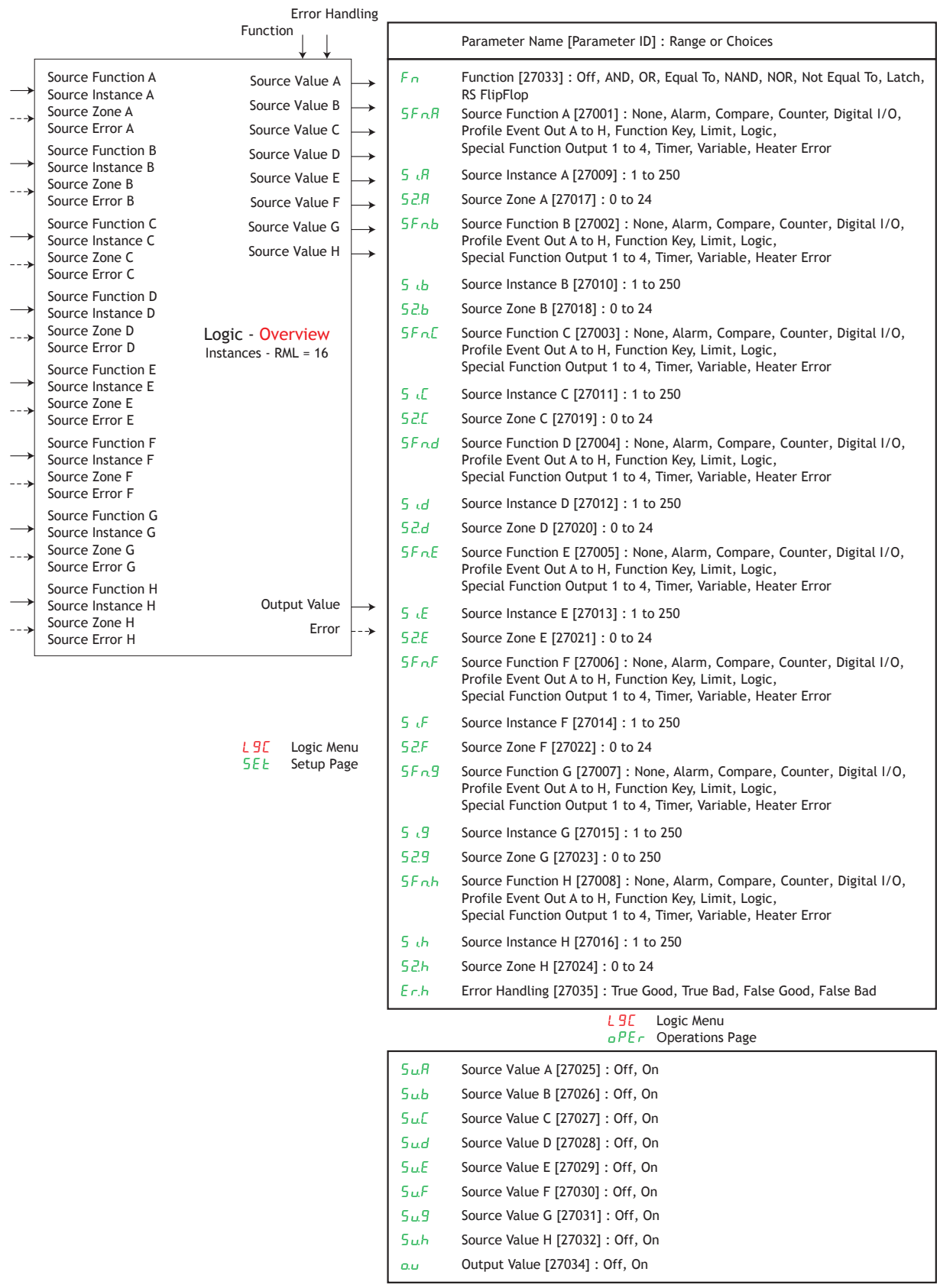

# Logic (cont.)

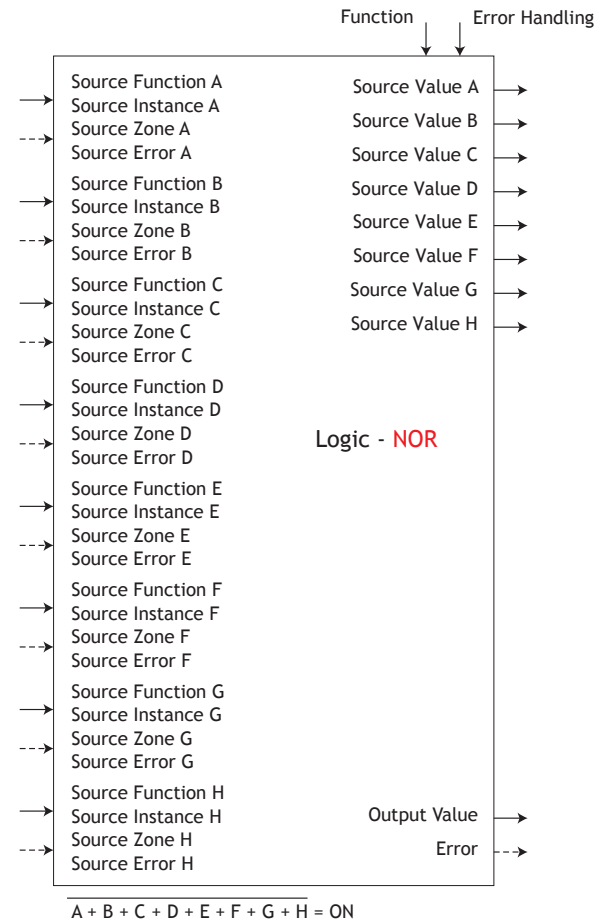
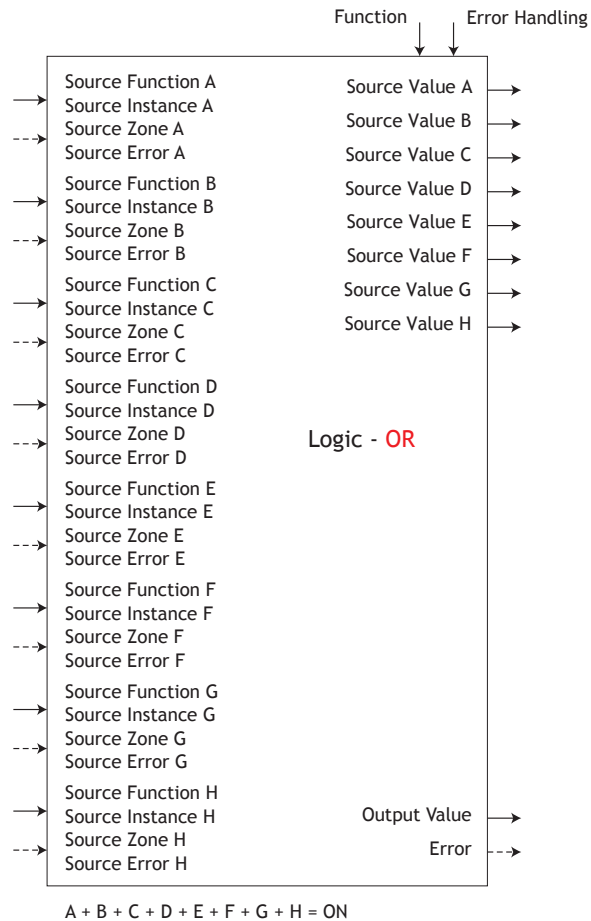
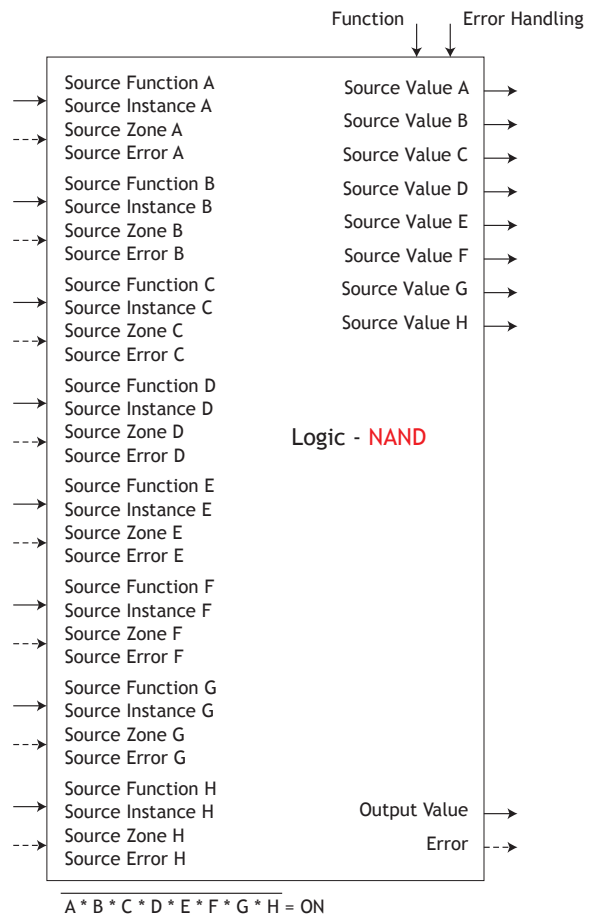
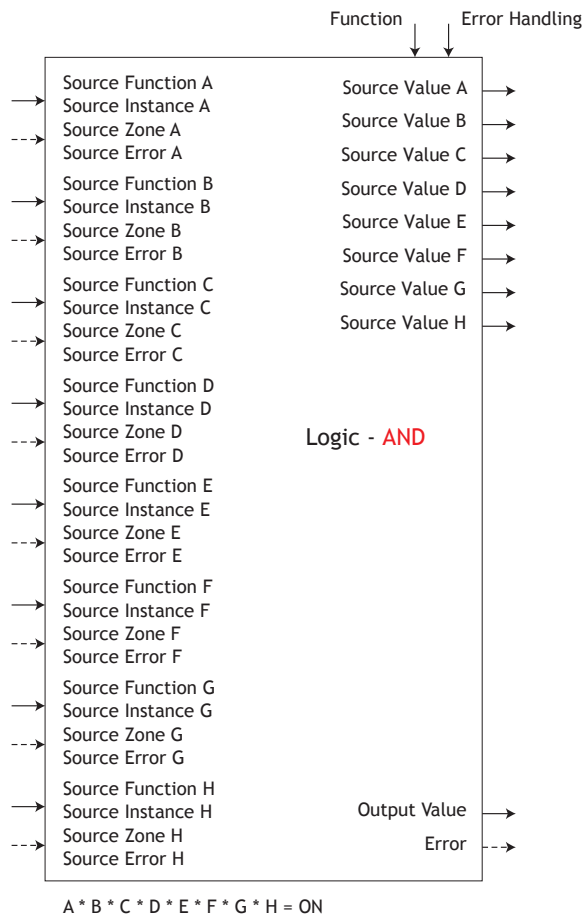

# Logic (cont.)

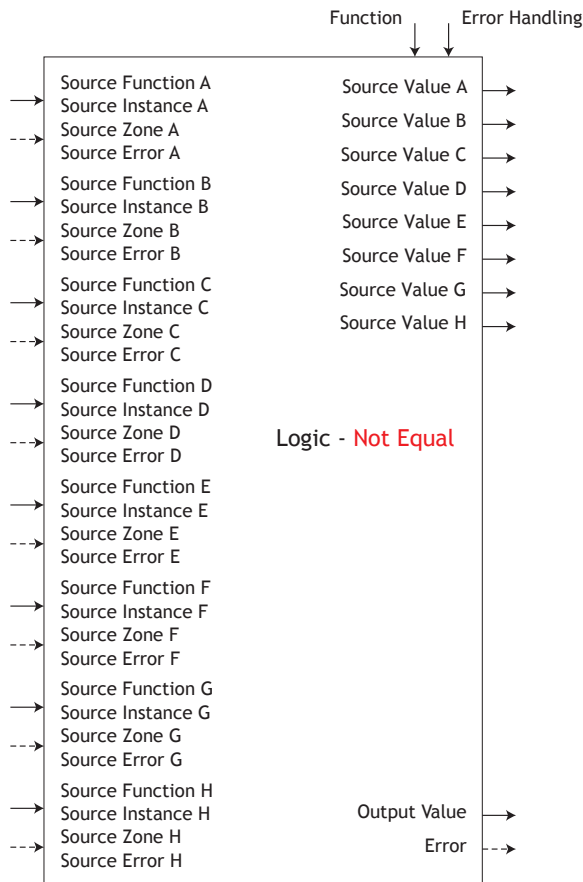

If A ≠ B ≠ C ≠ D ≠ E ≠ F ≠ G ≠ H then ON

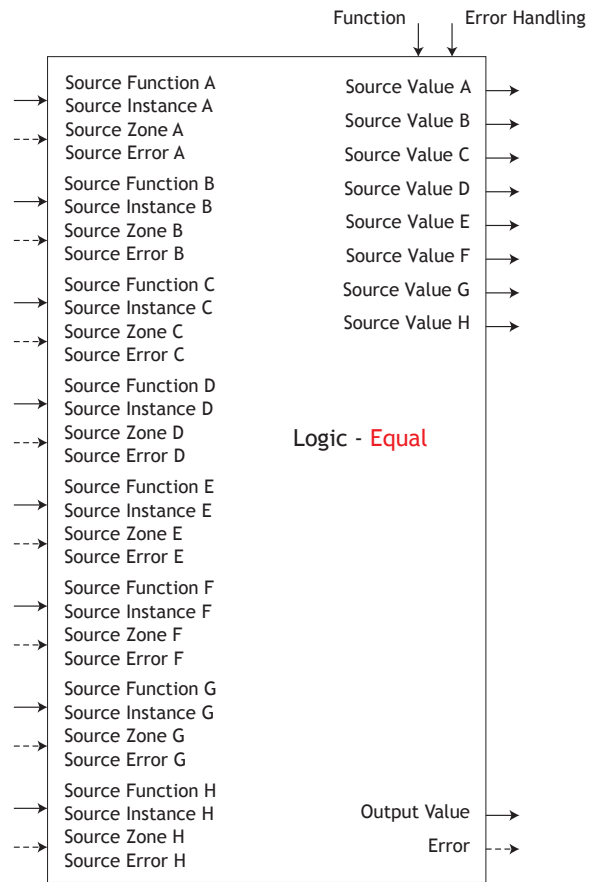

If A = B = C = D = E = F = G = H then ON

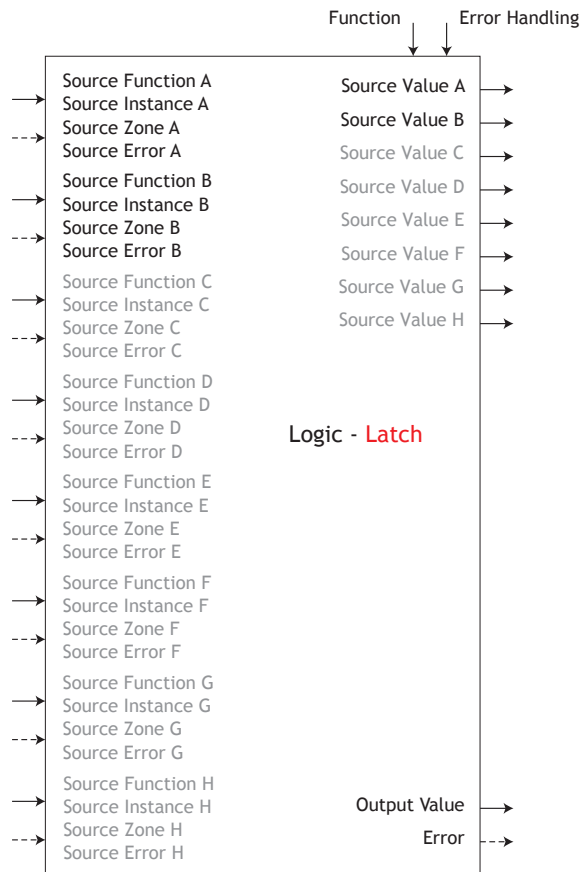

Output Value follows A, unless B = ON  
 Latch Output while B = ON

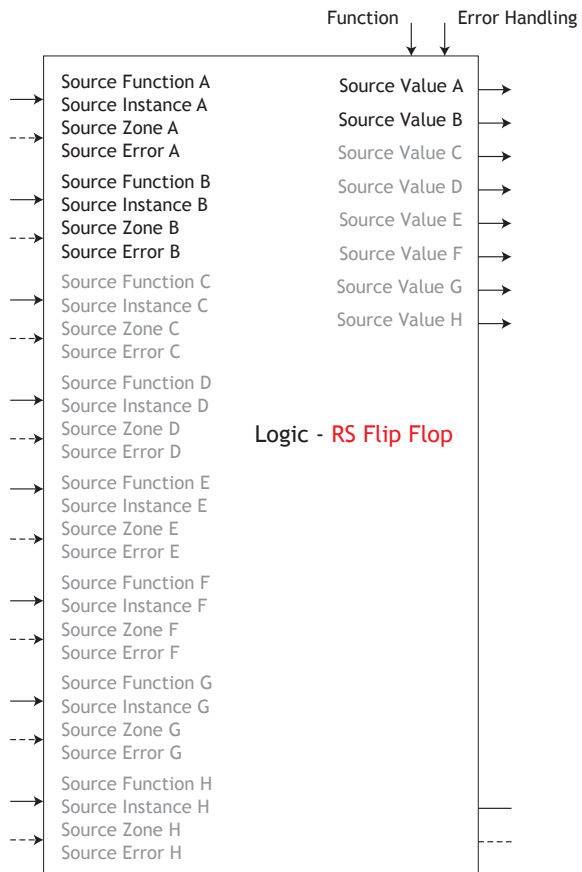

☐ A Sets Output Value ON, ☐ B Resets Output Value OFF



## Logic (cont.)

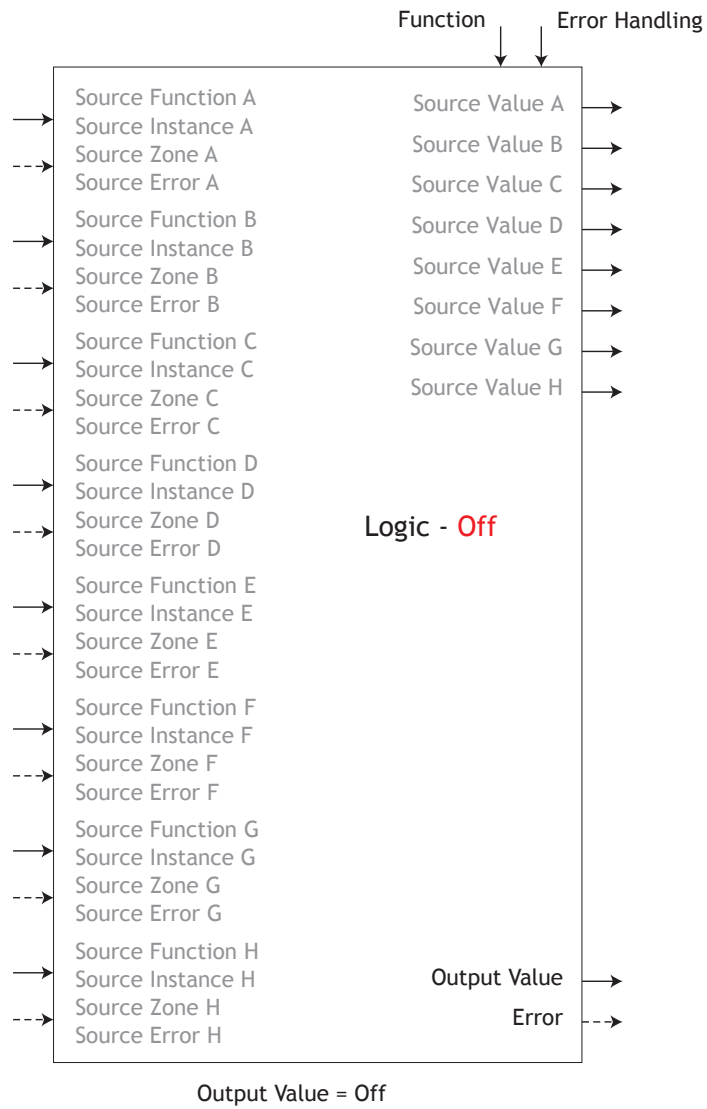

# Math Function

The Math function block accepts multiple inputs and performs a programmed math function to derive an output value with Filter and Offset values applied. It is assumed that no input error conditions apply. Some math operations must be performed in the user's units. Functions may combine multiple inputs. Those inputs may have incompatible units from a logical point of view. As a result, unless otherwise indicated, the presentation of the output value is the same as Source A. This accommodates temperatures being multiplied, divided and offset by constants and process inputs. Only inputs pointed to a source are used in the calculations.

- Error [25029]: None, Open, Shorted, Measurement Error, Bad Cal Data, Ambient Error, RTD Error, Fail, Math Error, Not Sourced, Stale

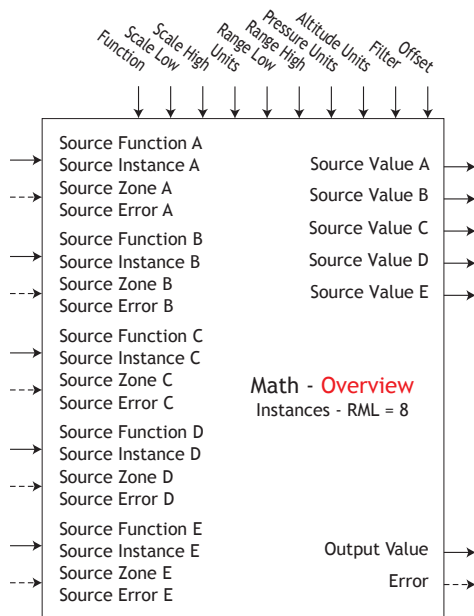

**MATH** Math Menu  
**SET** Setup Page

Parameter Name [Parameter ID] : Range or Choices	
<b>F n</b>	Function [25021] : Off, Average, Process Scale, Deviation Scale, Switch Over, Differential, Ratio, Add, Multiply, Absolute Difference, Minimum, Maximum, Square Root, Sample and Hold, Pressure to Altitude, Dewpoint
<b>SFnA</b>	Source Function A [25001] : None, Analog Input, Current, Cool Power, Heat Power, Power, Linearization, Math, Process Value, Set Point Closed, Set Point Open, Variable, Wattage, Load Voltage, Load Resistance
<b>S iA</b>	Source Instance A [25006] : 1 to 250
<b>SZA</b>	Source Zone A [25011] : 0 to 24
<b>SFnB</b>	Source Function B [25005] : None, Analog Input, Current, Cool Power, Heat Power, Power, Linearization, Math, Process Value, Set Point Closed, Set Point Open, Variable, Wattage, Load Voltage, Load Resistance
<b>S iB</b>	Source Instance B [25007] : 1 to 250
<b>SZB</b>	Source Zone B [25012] : 0 to 24
<b>SFnC</b>	Source Function C [25003] : None, Analog Input, Current, Cool Power, Heat Power, Power, Linearization, Math, Process Value, Set Point Closed, Set Point Open, Variable, Wattage, Load Voltage, Load Resistance
<b>S iC</b>	Source Instance C [25008] : 1 to 250
<b>SZC</b>	Source Zone C [25013] : 0 to 24
<b>SFnD</b>	Source Function D [25004] : None, Analog Input, Current, Cool Power, Heat Power, Power, Linearization, Math, Process Value, Set Point Closed, Set Point Open, Variable, Wattage, Load Voltage, Load Resistance
<b>S iD</b>	Source Instance D [25009] : 1 to 250
<b>SZD</b>	Source Zone D [25014] : 0 to 24
<b>SFnE</b>	Source Function E [25005] : None, Alarm, Compare, Counter, Digital I/O, Profile Event Out A to H, Function Key, Logic, Timer, Variable
<b>S iE</b>	Source Instance E [25010] : 1 to 250
<b>SZE</b>	Source Zone E [25015] : 0 to 24
<b>SLo</b>	Scale Low [25024] : -1,999.0 to 9,999.0
<b>SHi</b>	Scale High [25025] : -1,999.0 to 9,999.0
<b>Un iE</b>	Unit [25032] Source, None, Absolute Temperature, Relative Temperature, Power, Process, Relative Humidity
<b>rLo</b>	Range Low [25026] : -1,999.0 to 9,999.0
<b>rHi</b>	Range High [25027] : -1,999.0 to 9,999.0
<b>P.unE</b>	Pressure Units [25030] : PSI, Torr, mBar, Atmosphere, Pascal
<b>Al.unE</b>	Altitude Units [25031] : Feet, Kilofeet
<b>F iL</b>	Filter [25028] : 0.0 to 60.0 seconds

<b>SuA</b>	Source Value A [25016] : -1,999.000 to 9,999.000
<b>SuB</b>	Source Value B [25017] : -1,999.000 to 9,999.000
<b>SuC</b>	Source Value C [25018] : -1,999.000 to 9,999.000
<b>SuD</b>	Source Value D [25019] : -1,999.000 to 9,999.000
<b>SuE</b>	Source Value E [25020] : Off, On
<b>ou</b>	Output Value [25022] : -1,999.000 to 9,999.000
<b>oFS</b>	Offset [25023] : -1,999.000 to 9,999.000

Error [25029]: None, Open, Shorted, Measurement Error, Bad Cal Data, Ambient Error, RTD Error, Fail, Math Error, Not Sourced, Stale

# Math (cont.)

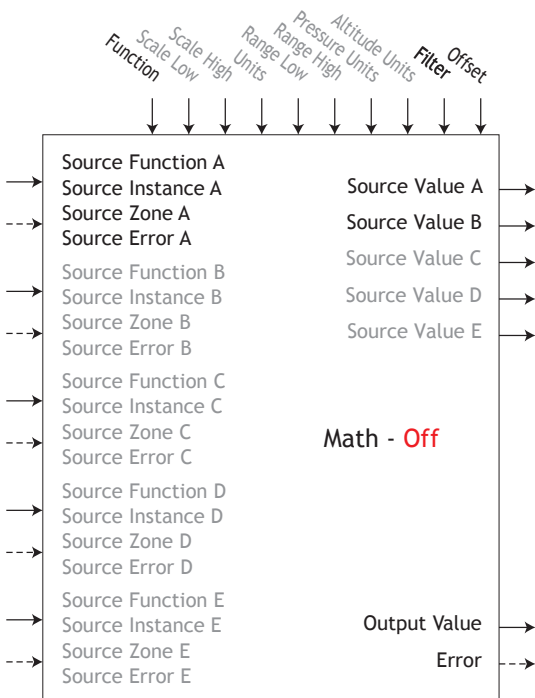

Output Value = Filter [A + Offset]  
 Display units follows Source A

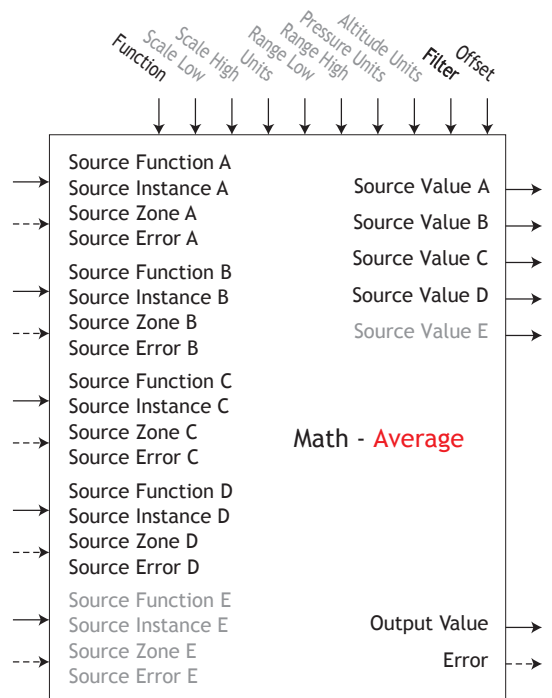

Output Value = Filter [(Average (A + B + C + D)) + Offset]  
 Display units follows the last source that is temperature else follow Source A

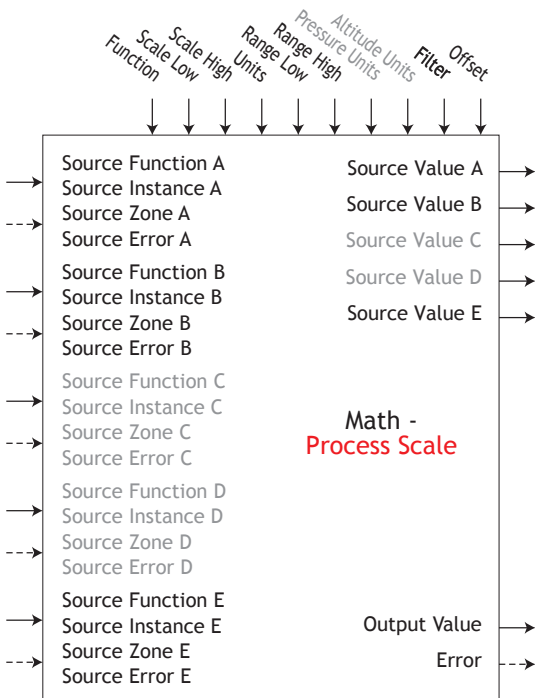

If B = OFF, Output Value = Filter [(Range High - Range Low) / (Scale High - Scale Low) \* (A - Scale Low) + Range Low + Offset]  
 If B = ON, Output Value = Filter [B + Offset]

Scale Low/High and Range Low/High follows Source A display units when Units is set to Source, else follow Units setting.

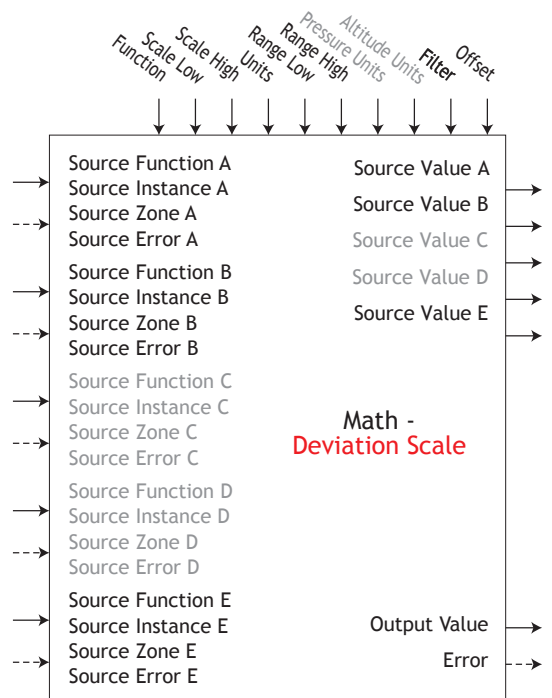

If B = OFF, Output Value = Filter [(Range High - Range Low) / (Scale High - Scale Low) \* (A - Scale Low) + Range Low + B + Offset]  
 If B = ON, Output Value = Filter [B + Offset]

Scale Low/High and Range Low/High follows Source A display units when Units is set to Source, else follow Units setting.

# Math (cont.)

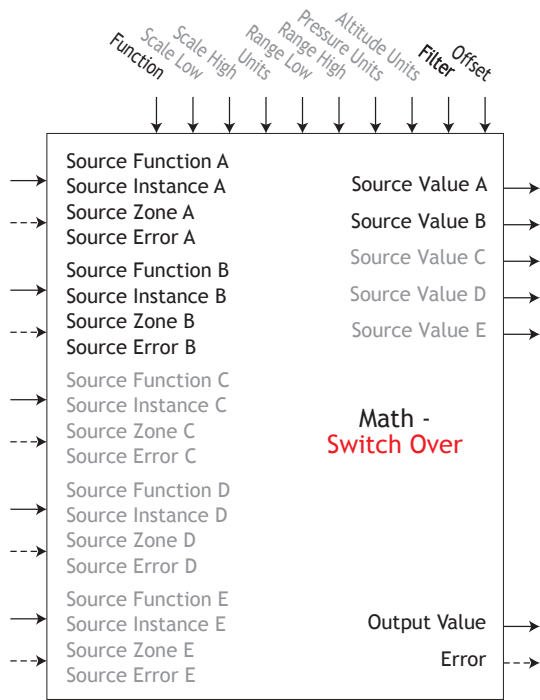

If B = OFF, Output Value = Filter [A + Offset]  
 If B = ON, Output Value = Filter [B + Offset]  
 Display units follows active source.

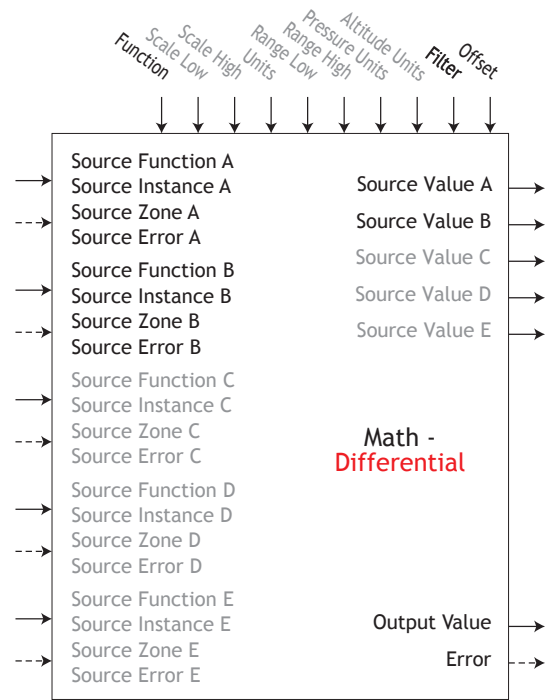

Output Value = Filter [(A - B) + Offset]  
 Display units follows Source A plus relative Source B

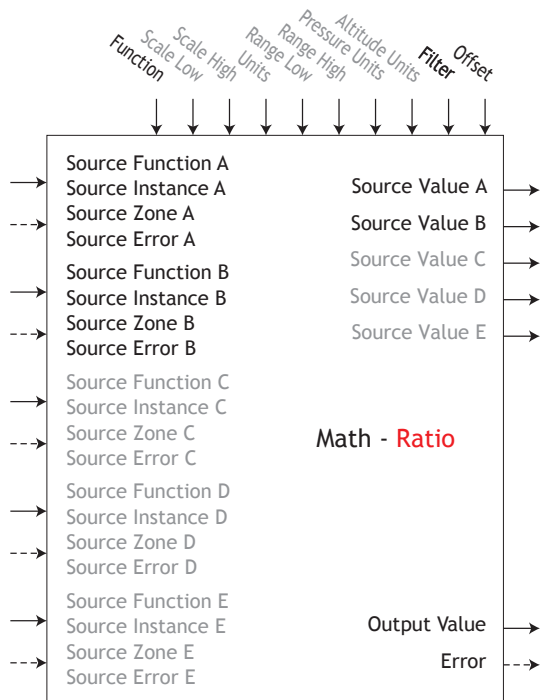

Output Value = Filter [(A / B) + Offset]  
 If display units of Source A = Source B, no display units on output value, else follow Source A

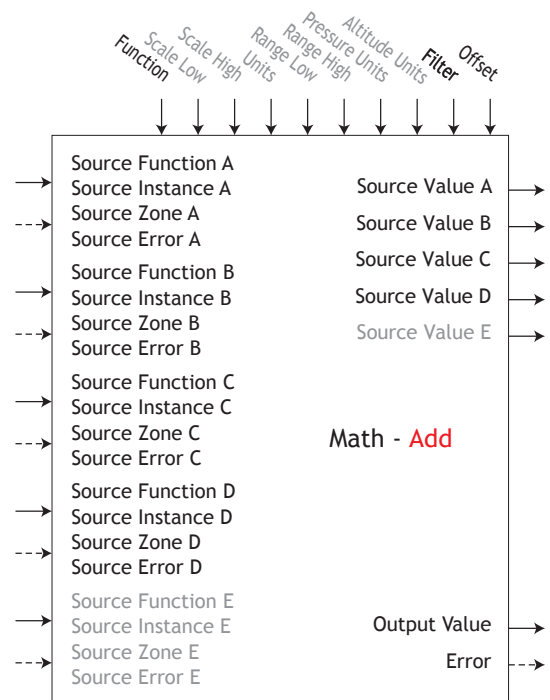

Output Value = Filter [(A + B + C + D) + Offset]  
 Display units follows last temperature source else follow Source A

# Math (cont.)

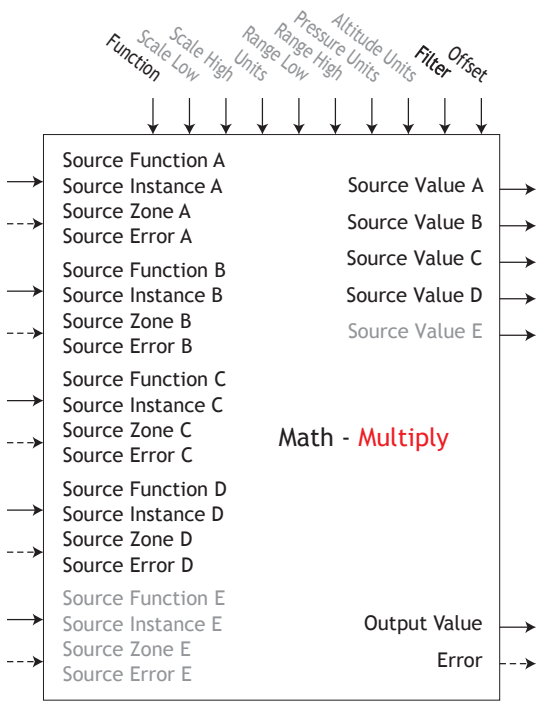

Output Value = Filter [(A \* B \* C \* D) + Offset]  
Display units follows last temperature source else follow Source A

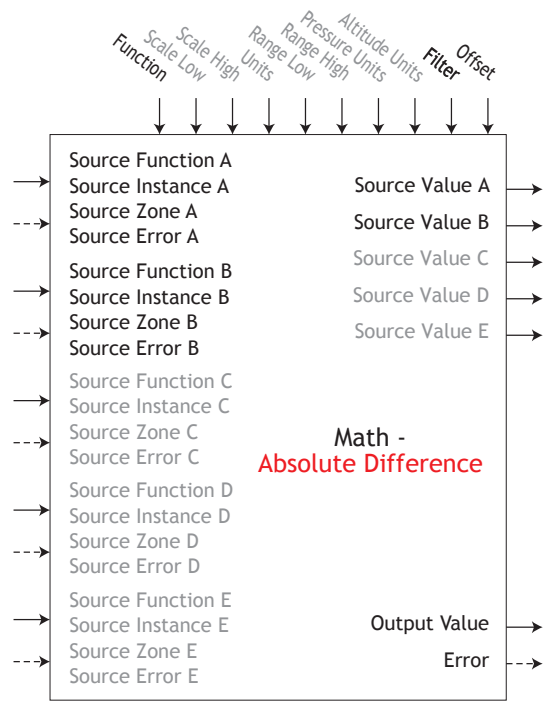

Output Value = Filter [| A - B | + Offset]  
Display units follow Source A plus relative Source B

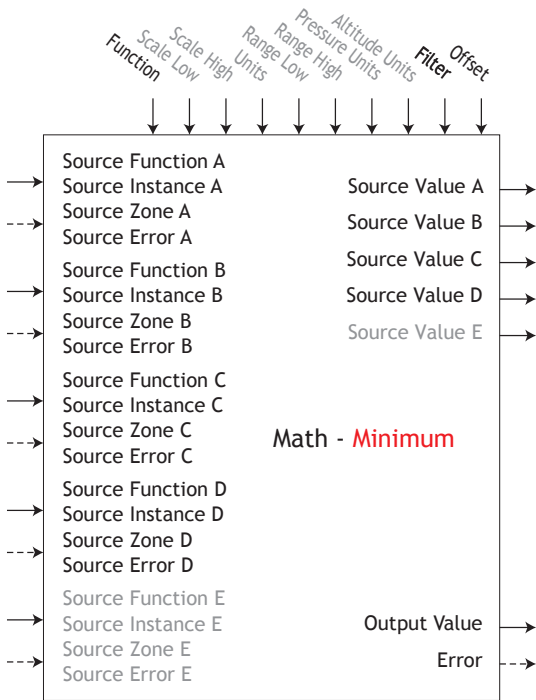

Output Value = Filter [Minimum Value (A : B : C : D) + Offset]  
Display units follows Source with minimum value.

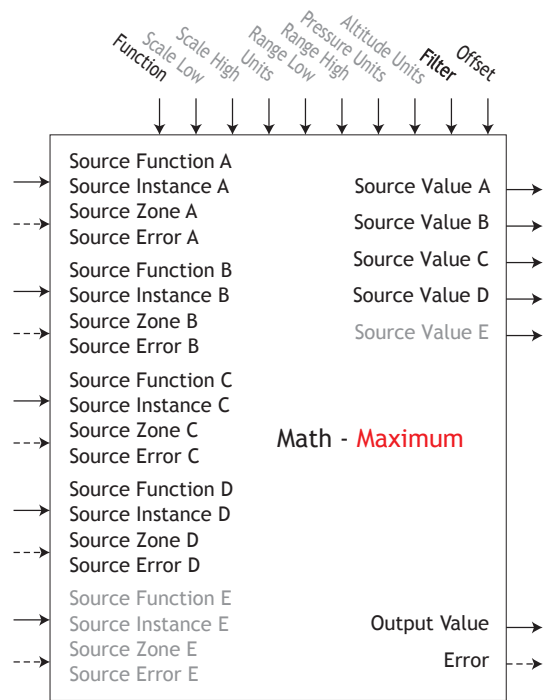

Output Value = Filter [Maximum Value (A : B : C : D) + Offset]  
Display units follows Source with maximum value.

# Math (cont.)

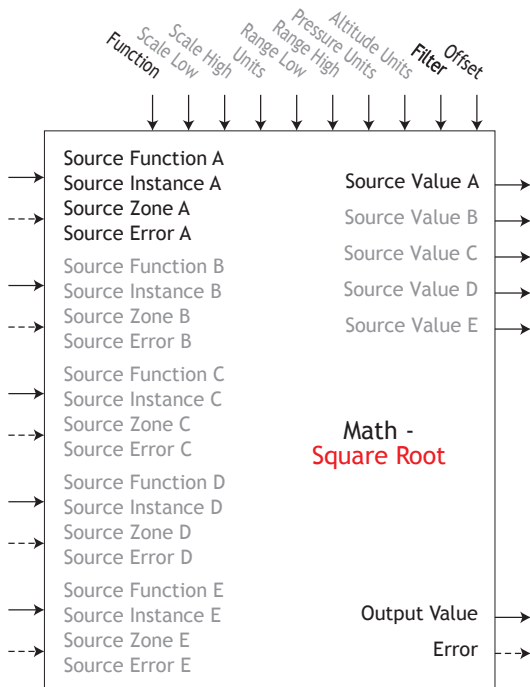

Output Value = Filter [Sqr Root A + Offset]  
 Display units follows Source A

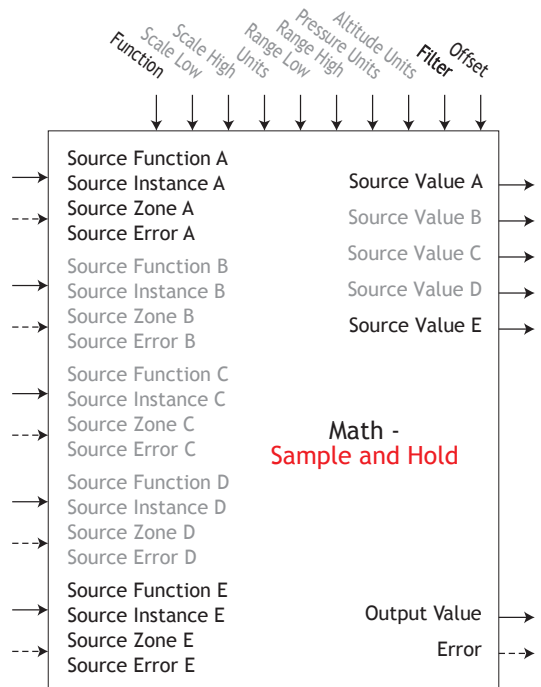

If E = OFF, Output Value = Filter [A + Offset]  
 If E = ON, Output Value = Filter [last value of A + Offset]  
 Display units follows Source A

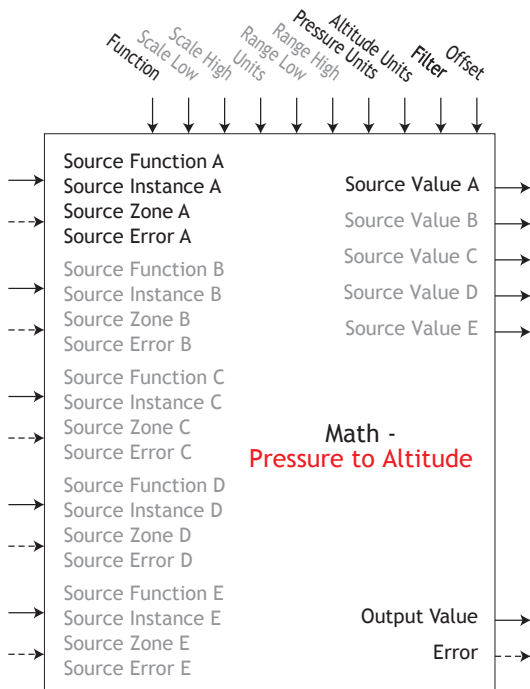

Output Value = Filter [Convert Source A in Pressure to Altitude + Offset]

Note: Pressure Altitude calculation is based on the International Standard Atmosphere 1976. Source A is a pressure signal and needs to be in PSI units for the calculation. The calculation is accurate from sea level to 90,000 feet. It can be used beyond this range in both directions, but with loss of accuracy. The standard is based on an altitude of 0 feet (sea level) pressure of 14.6967 PSI and a temperature of 59 degrees F. Result of calculation is in feet.

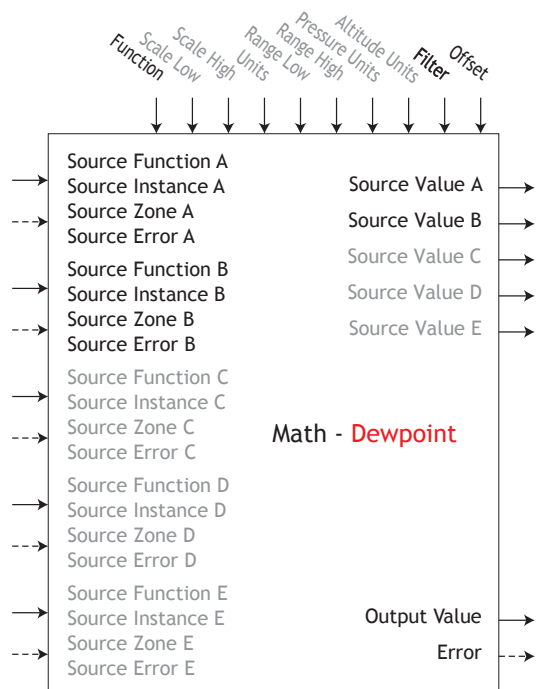

Output Value = Filter [427.26 \* (CP \* B / 8.8618) / (17.27 - (CP \* B / 8.8618)) + 32 + Offset]

Source A is used for Calculated Pressure or CP ;

Note: For dewpoint, Source A is temperature (F) and Source B is RH (%). Saturation pressure calculation is identical to that used in wet/dry bulb. Result is in degrees F.

## Modbus® Function

Configure the Modbus RTU serial communication settings using these parameters.

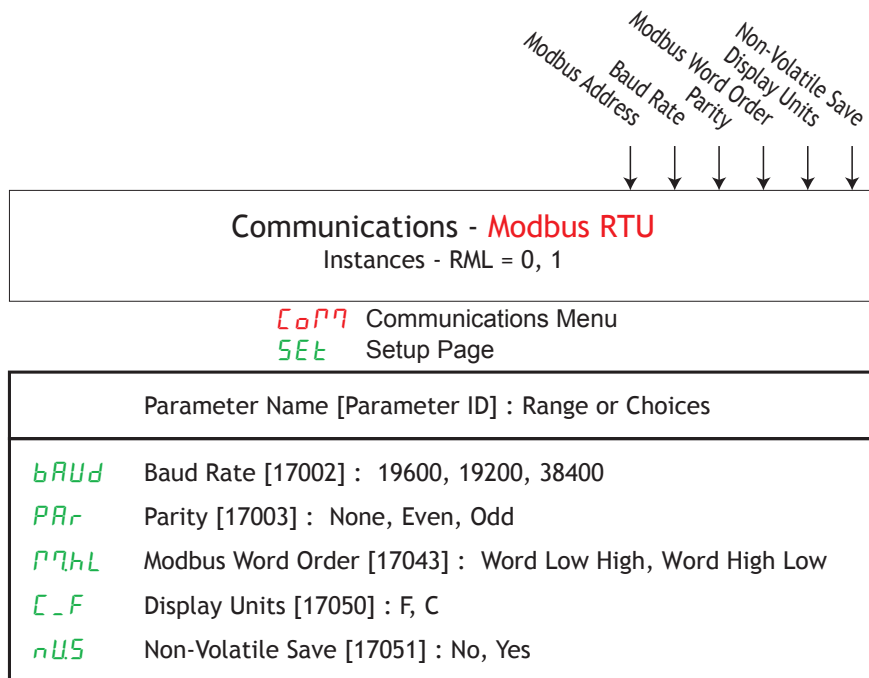

## Output Function

This function configures and connects physical outputs to internal functions.

### Note:

Digital Outputs not included on these sheets

- Output Value [18019] : 0 to 10.0 volts or 0 to 20.00 milliamperes
- Output Value [6011] : On, Off
- Error: None, Open, Shorted, Measurement Error, Bad Cal Data, Ambient Error, RTD Error, Fail, Math Error, Not Sourced, Stale

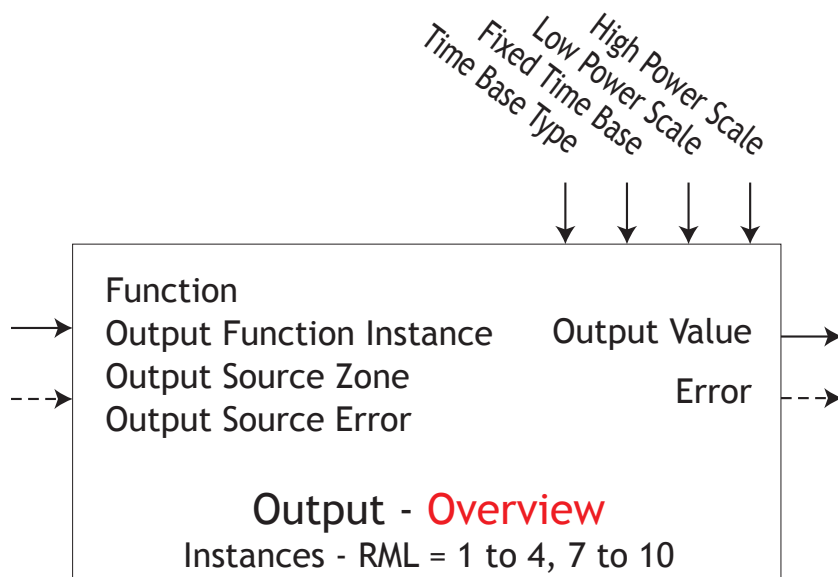

**oLPL** Output Menu  
**SEt** Setup Page

Parameter Name [Parameter ID] : Range or Choices	
<b>Fn</b>	Function [6005] : Off, Analog Input, Alarm, Cool Power, Heat Power, Compare, Counter, Digital I/O, Profile Event Out A to H, Function Key, Logic, Linearization, Math, Process Value, Special Function Output 1 to 4, Timer, Variable, Limit, Heater Error, Module Limit (instance 8)
<b>Fi</b>	Output Function Instance [6006] : 1 to 250
<b>SZ</b>	Output Source Zone [6012] : 0 to 24
<b>oLb</b>	Time Base Type [6002] : Fixed Time Base, Variable Time Base
<b>oLb</b>	Fixed Time Base [6003] : 0.1 to 60.0 seconds
<b>oLo</b>	Low Power Scale [6009] : 0 to 100 %
<b>oHi</b>	High Power Scale [6010] : 0 to 100 %



## Security Function

If Password is enabled, the user must enter the Password to get to menus that have been blocked due to lock level settings. Rolling passwords required a new password each time the power has been cycled to the controller. It will be different for every controller. The administrator password is required to change the security settings even if the user enters their password to override the security settings.

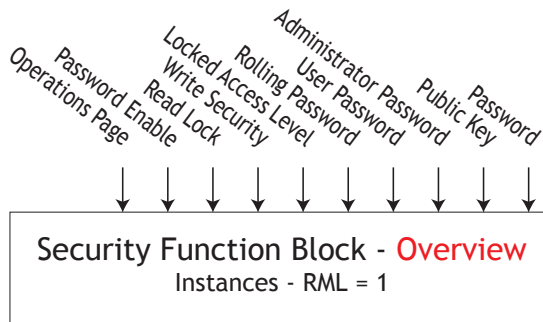

**LoE** Lock Menu  
**FRcE** Factory Page

Parameter Name [Parameter ID] : Range or Choices	
<b>LoEo</b>	Operations Page [3002] : 1 to 3
<b>PA5E</b>	Password Enable [3015] : Off, On
<b>r.LoE</b>	Read Lock [3010] : 1 to 5
<b>5.LoE</b>	Write Security [3011] : 1 to 5
<b>LoEL</b>	Locked Access Level [3016] : 1 to 5
<b>roLL</b>	Rolling Password [3019] : Off, On
<b>PA5u</b>	User Password [3017] : 10 to 999
<b>PA5A</b>	Administrator Password [3018] : 10 to 999

**ULoE** Unlock Menu  
**FRcE** Factory Page

<b>CoDE</b>	Public Key [3020] : 0 to 9999
<b>PA55</b>	Password [3022] : 10 to 999

## Timer Function

- Error [31018] = None, Open, Shorted, Measurement Error, Bad Cal Data, Ambient Error, RTD Error, Fail, Math Error, Not Sourced, Stale
- Running [31015] = Off, ON

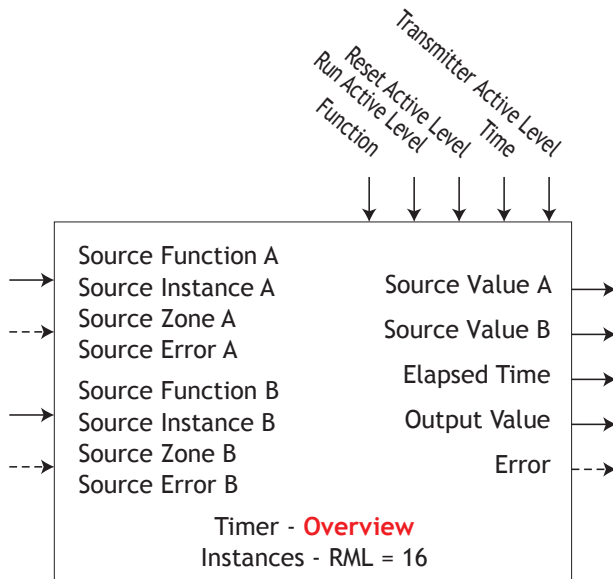

**LF7r** Timer Menu  
**SEt** Setup Page

Parameter Name [Parameter ID] : Range or Choices	
<b>Fn</b>	Function [31009] : Off, On Pulse, Delay, One Shot, Retentive
<b>SFnA</b>	Source Function A [31001] : None, Alarm, Compare, Counter, Digital I/O, Profile Event Out A to H, Function Key, Logic, Special Function Output 1 to 4, Timer, Variable
<b>SiA</b>	Source Instance A [31003] : 1 to 250
<b>SZA</b>	Source Zone A [31005] : 0 to 24
<b>SASA</b>	Run Active Level [31011] : High (rising), Low (falling)
<b>SFnB</b>	Source Function B [31002] : None, Alarm, Compare, Counter, Digital I/O, Profile Event Out A to H, Function Key, Logic, Special Function Output 1 to 4, Timer, Variable
<b>SiB</b>	Source Instance B [3104] : 1 to 250
<b>SZB</b>	Source Zone B [31006] : 0 to 24
<b>SASB</b>	Reset Active Level [31012] : High (rising), Low (falling)
<b>t</b>	Time [31013] : 0.0 to 9,999.0 seconds
<b>LEu</b>	Active Level [31014] : High, Low

**LF7r** Timer Menu  
**oPEr** Operations Page

<b>SuA</b>	Source Value A [31007] : Off, On
<b>SuB</b>	Source Value B [31008] : Off, On
<b>Et</b>	Elapsed Time [31016] : 0.0 to 9,999.0 seconds
<b>ou</b>	Output Value [31010] : Off, On

## Timer (cont.)

Off

Output Value = OFF

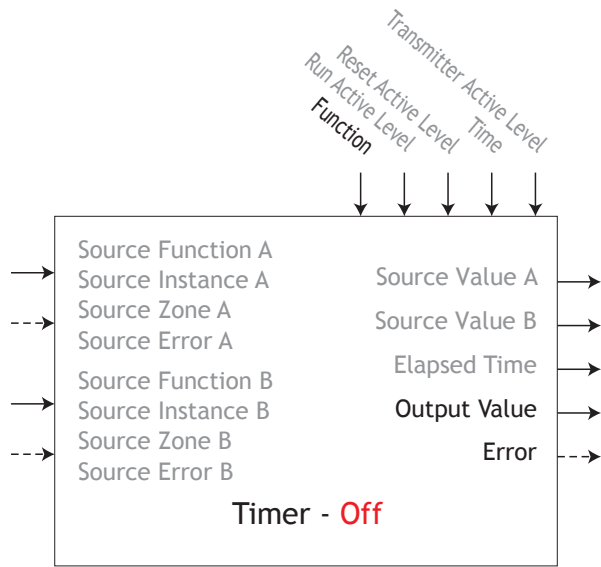

## Timer (cont.)

### On Pulse

An On Pulse Timer is used to produce an output pulse of a constant duration. It can be used as a minimum on time for compressor control or other devices that do not want excessive cycling. Use Function to select On Pulse.

- On Pulse timers output a pulse of a set duration that is triggered or restarted by the level of Source A.
- Source Function A selects the type of source used for the input.
- Source Instance A and Source Zone A selects which source to use.
- Run Active Level sets which state makes the timer run or reset.
- Time sets the time duration of the output pulse.
- Transmitter Active Level sets which output state indicates the elapsed time is greater than or equal to the Time setting.

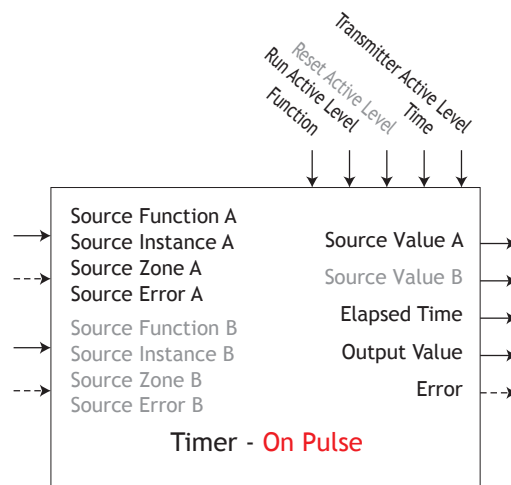

Timing Diagram of On Pulse with active state rising edge

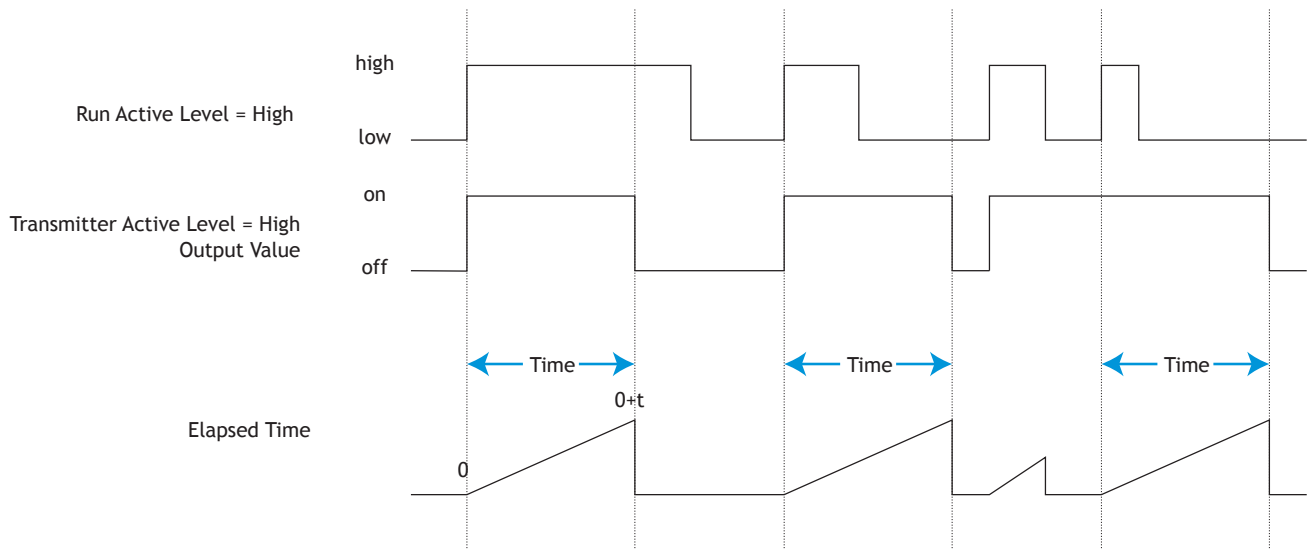

## Timer (cont.)

### Delay

A delay timer is used to cause a delaying action. The delay can be made to happen on either the leading or trailing edge. This can be used to keep short input pulses from propagating or to have a secondary action occur at a known amount of time after the primary action; such as, turning on successive output devices.

- Use Function to select Delay.
- Delay timers will delay the response of a signal presented to Source A and then switch the output value.
- Source Function A selects the type of source used for the input.
- Source Instance A and Source Zone A selects which source to use.
- Run Active Level sets which state makes the timer run or reset.
- Overlap of run signal to time signal determines output value on time. If run signal is less than time signal, output does not activate.
- Transmitter Active Level sets which output state indicates the run time is greater than the Time setting.

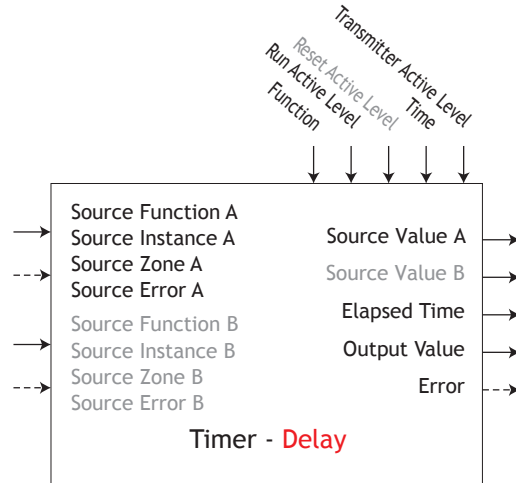

Timing Diagram of Delay with active state rising edge

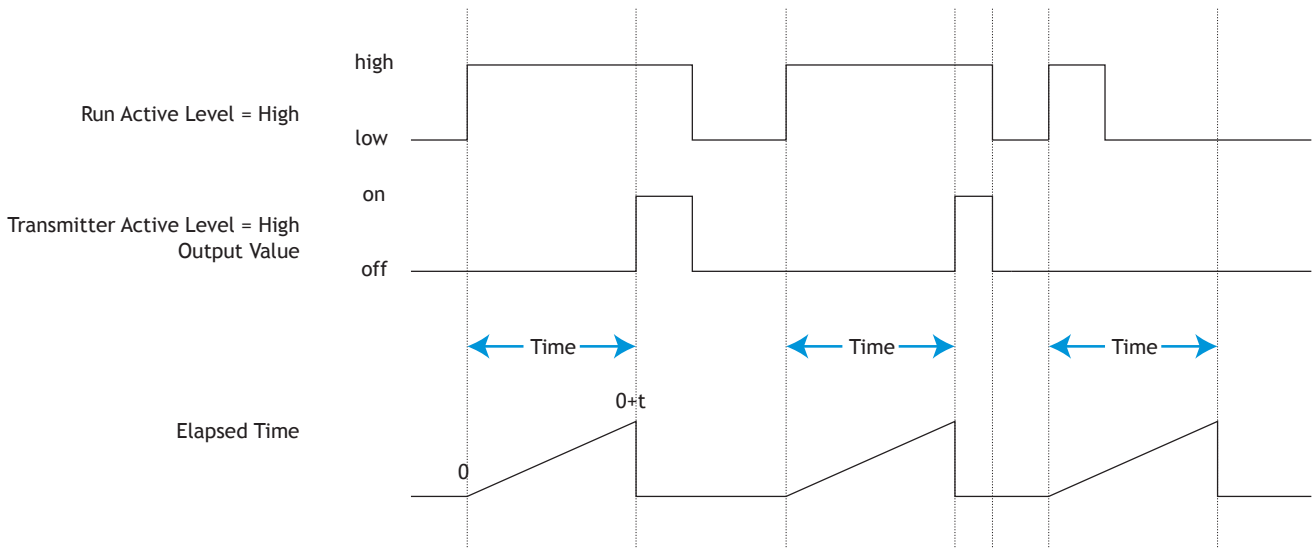

## Timer (cont.)

### One Shot

The One Shot timer functions like a simple oven timer. The time value gets set by the user and it counts down to zero without retaining the original time (hence the name one-shot). This is intended to be used in applications where the user will manually set different times for each process.

- Use Function to select One Shot.
- One Shot timers count down while Source A is active; otherwise it holds. Preset of Time clears once time is elapsed.
- Source Function A selects the type of source used for the input.
- Source Instance A and Source Zone A selects which source to use.
- Run Active Level sets which state makes the timer count down.
- Transmitter Active Level sets which output state indicates the the timer is in countdown operation.

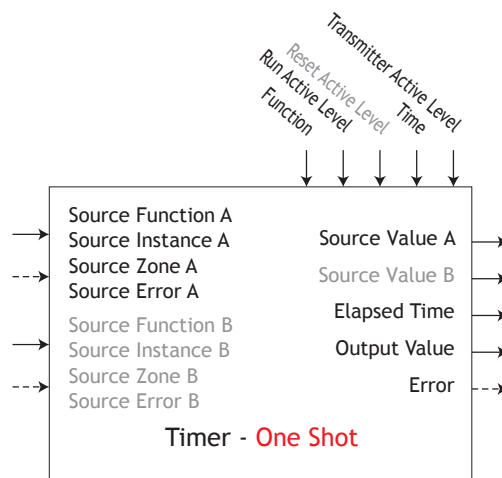

Timing Diagram of One Shot with active state rising edge

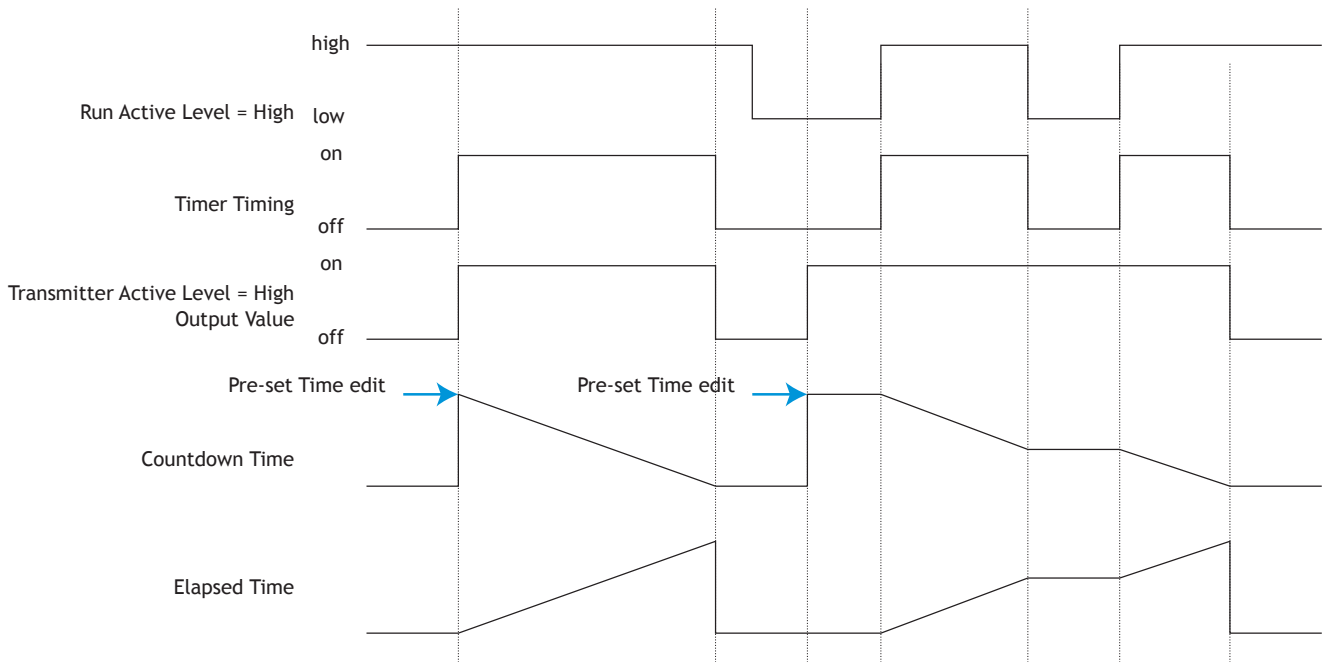

## Timer (cont.)

### Retentive

A retentive timer is used to keep track of how much time something has been in a particular state. For example, this can be used to time how long something has been in an alarm state or how long it has been since a profile or step ran. The output can be used to trigger an event if the elapsed time has grown excessive.

- Use Function to select Retentive.
- Retentive timers count up from 0 to the Time parameter while Source A is active; otherwise it holds. It can be reset by Source B. The Elapsed time will continue to count up until the maximum value is reached and then rolls over unless a reset pulse is generated.
- Source Function A selects the type of source used for the input.
- Source Instance A and Source Zone A selects which source to use.
- Run Active Level sets which state makes the timer countdown.
- Transmitter Active Level sets which output state indicates the the timer is in countdown operation.

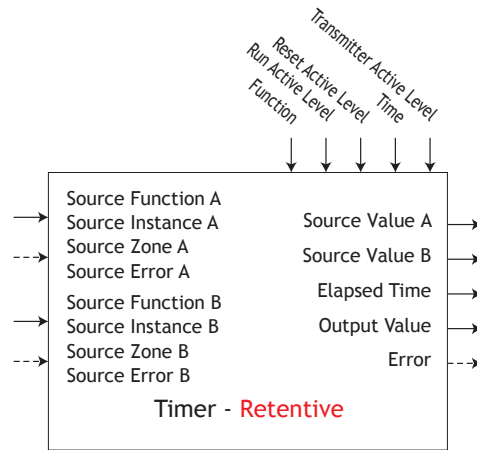

Timing Diagram of Retentive with all active state rising edge

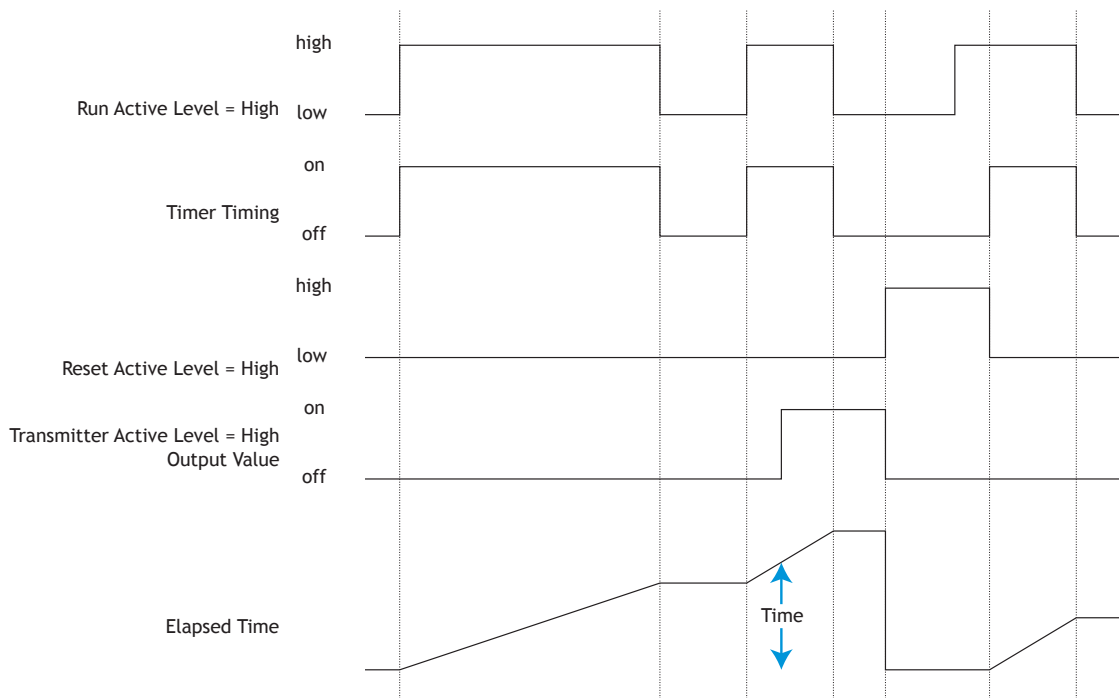

## Variable Function

A variable function block is used to store a user supplied value and provide a source input to another function block with that value. As an example, you could use a variable function value as one input to a compare function. The other input to the compare function would determine the output value based on the user's supplied value.

This function simply passes the stored value to its output.

- Error [2005] : None, Open, Shorted, Measurement Error, Bad Cal Data, Ambient Error, RTD Error, Fail, Math Error, Not Sourced, Stale
- Output Value [2004] : -1,999.000 to 9,999.000 or On or Off

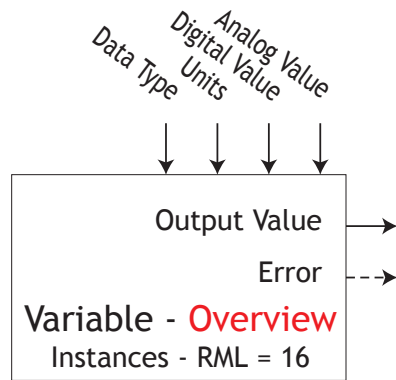

*uAr* Variable Menu  
*SEt* Setup Page

Parameter Name [Parameter ID] : Range or Choices	
<i>TYPE</i>	Data Type [2001] : Analog, Digital
<i>Unit</i>	Units [2007] : None, Absolute Temperature, Relative Temperature, Power, Process, Relative Humidity
<i>dig</i>	Digital Value [2002] : On, Off
<i>ANLG</i>	Analog Value [2003] : -1,999.000 to 9,999.000

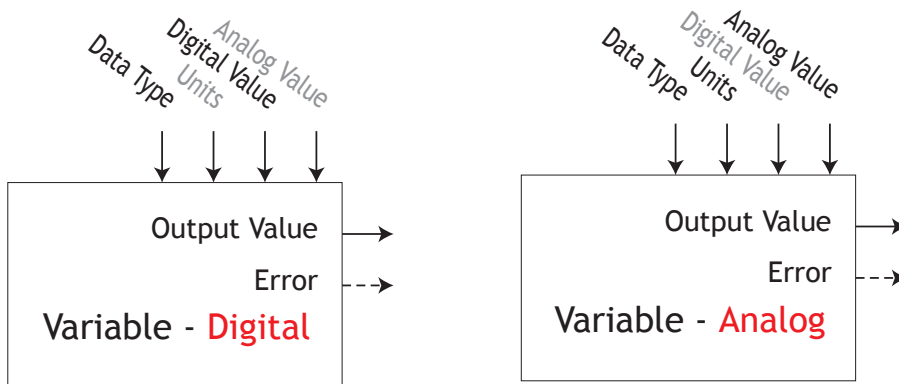



# 8

## Chapter 8: Appendix

### Modbus® - Programmable Memory Blocks

The Modbus assembly contains 40 pointers to the parameters of your choosing starting at Modbus register 40 (shown on the following page). The pointers are 32-bits long so are stored in two sequential registers. As an example, if we want to move the analog input of the RML (register 410) into register 40, we perform a multiple write command (0x10 function) of 410 into register 40 and 411 into register 41 as a single multi-write command.

Once the parameters of choice have been defined and written to the pointer registers, the working registers 200 to 279 then represent those parameters. Therefore, as in the example above, if 410 is in register 40, 411 in register 41, register 200 & 201 contains the 32-bit floating point result for analog input 1.

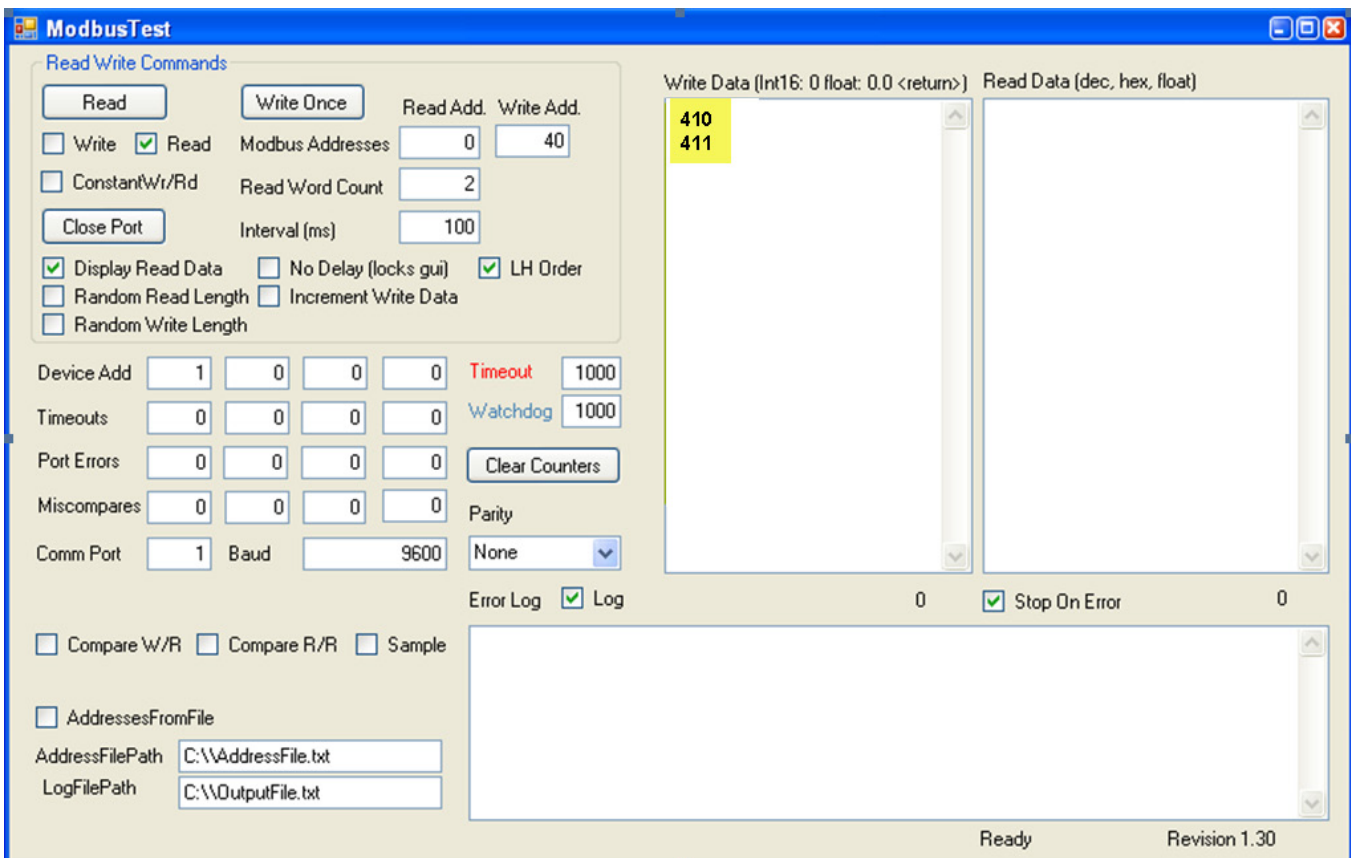

The screen shot above was taken from a program that can be found on the Watlow Support Tools DVD (shipped with the product) as well as on the Watlow website. On the DVD, it can be found under "Utility Tools" and is identified as "Modbus RTU Diagnostic Program for EZ-ZONE PM, RM and ST". A similar program can be found here as well for a connection utilizing Ethernet TCP/IP.

If it is easier to go to the web to acquire this software, click on the link below and type "modbus" in the search field where both versions can be found with the same name. <http://www.watlow.com/literature/software.cfm>

## Assembly Pointer Registers and Assembly Working Registers

Pointer Addresses	Working Addresses	Pointer Addresses	Working Addresses
40 & 41	200 & 201	120 & 121	280 & 281
42 & 43	202 & 203	122 & 123	282 & 283
44 & 45	204 & 205	124 & 125	284 & 285
46 & 47	206 & 207	126 & 127	286 & 287
48 & 49	208 & 209	128 & 129	288 & 289
50 & 51	210 & 211	130 & 131	290 & 291
52 & 53	212 & 213	132 & 133	292 & 293
54 & 55	214 & 215	134 & 135	294 & 295
56 & 57	216 & 217	136 & 137	296 & 297
58 & 59	218 & 219	138 & 139	296 & 299
60 & 61	220 & 221	140 & 141	300 & 301
62 & 63	222 & 223	142 & 143	302 & 303
64 & 65	224 & 225	144 & 145	304 & 305
66 & 67	226 & 227	146 & 147	306 & 307
68 & 69	228 & 229	148 & 149	308 & 309
70 & 71	230 & 231	150 & 151	310 & 311
72 & 73	232 & 233	152 & 153	312 & 313
74 & 75	234 & 235	154 & 155	314 & 315
76 & 77	236 & 237	156 & 157	316 & 317
78 & 79	238 & 239	158 & 159	318 & 319
80 & 81	240 & 241	160 & 161	320 & 321
82 & 83	242 & 243	162 & 163	322 & 323
84 & 85	244 & 245	164 & 165	324 & 325
86 & 87	246 & 247	166 & 167	326 & 327
88 & 89	248 & 249	168 & 169	328 & 329
90 & 91	250 & 251	170 & 171	330 & 331
92 & 93	252 & 253	172 & 173	332 & 333
94 & 95	254 & 255	174 & 175	334 & 335
96 & 97	256 & 257	176 & 177	336 & 337
98 & 99	256 & 259	178 & 179	338 & 339
100 & 101	260 & 261	180 & 181	340 & 341
102 & 103	262 & 263	182 & 183	342 & 343
104 & 105	264 & 265	184 & 185	344 & 345
106 & 107	266 & 267	186 & 187	346 & 347
108 & 109	268 & 269	188 & 189	348 & 349
110 & 111	270 & 271	190 & 191	350 & 351
112 & 113	272 & 273	192 & 193	352 & 353
114 & 115	274 & 275	194 & 195	354 & 355
116 & 117	276 & 277	196 & 197	356 & 357
118 & 119	278 & 279	198 & 199	358 & 359

# Modbus Default Assembly Structure 40-119

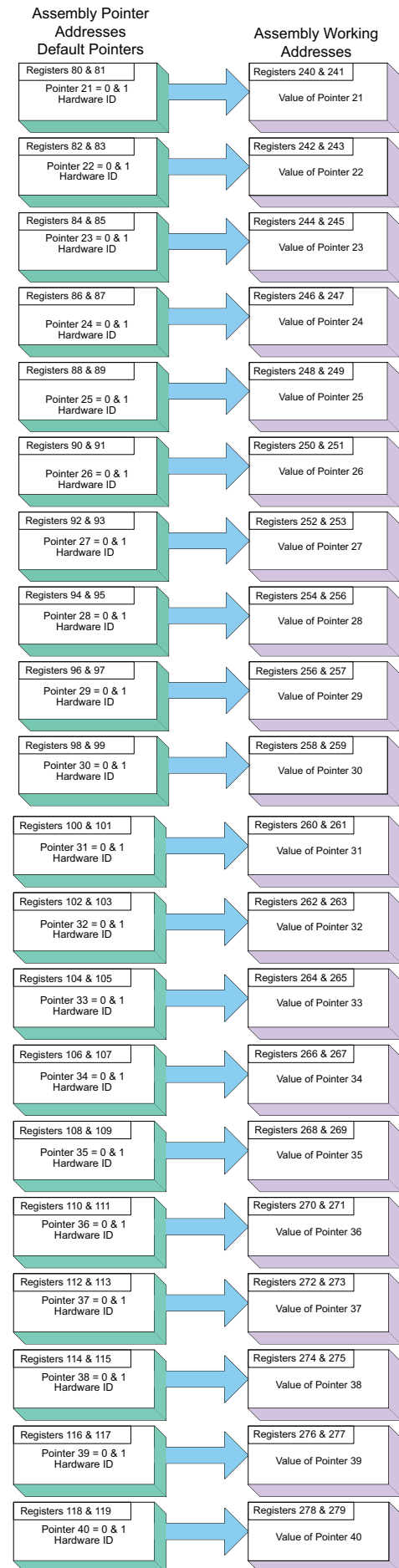
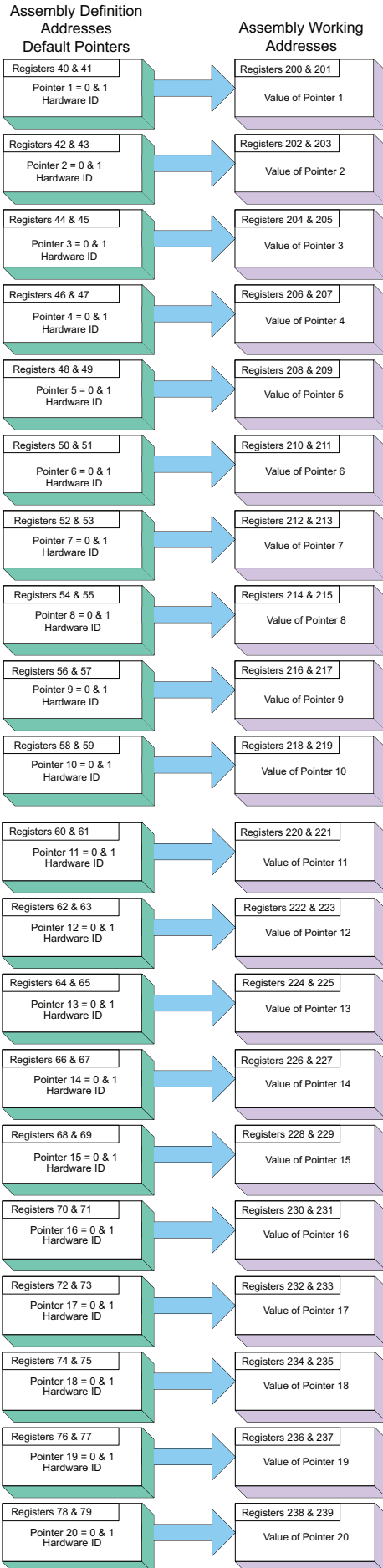

# Modbus Default Assembly Structure 120-199

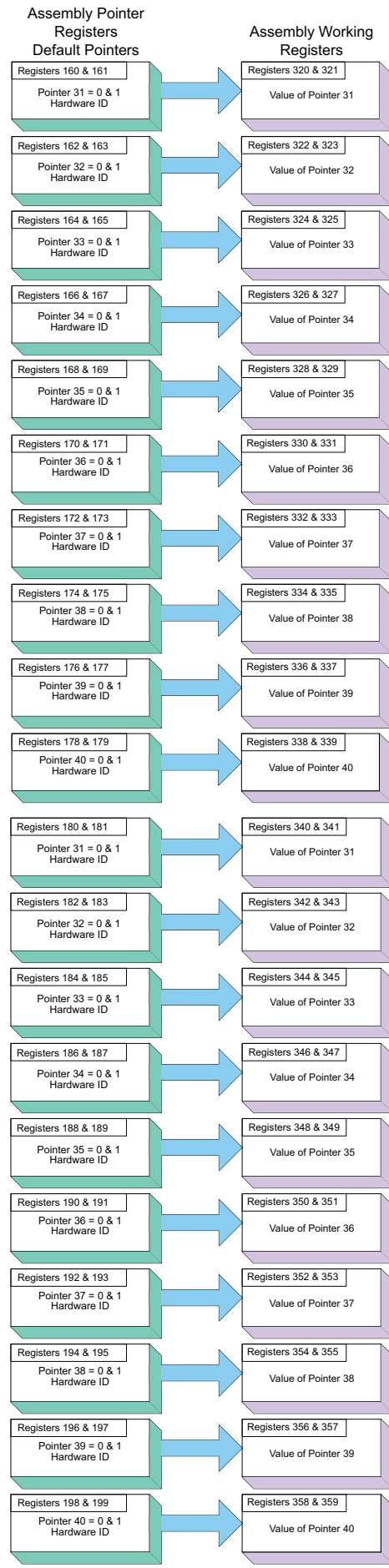
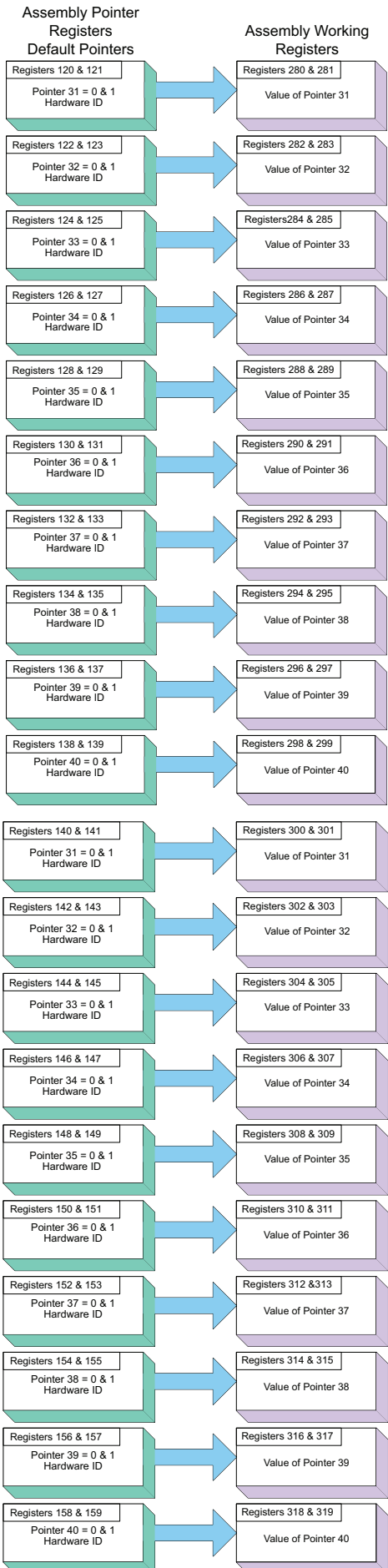

## Troubleshooting Alarms, Errors and Module Issues

Indication	Description	Possible Cause(s)	Corrective Action
Alarm won't clear or reset	Alarm will not clear or reset with keypad or digital input	<ul style="list-style-type: none"> <li>• Alarm latching is active</li> <li>• Alarm set to incorrect output</li> <li>• Alarm is set to incorrect source</li> <li>• Sensor input is out of alarm set point range</li> <li>• Alarm set point is incorrect</li> <li>• Alarm is set to incorrect type</li> <li>• Digital input function is incorrect</li> </ul>	<ul style="list-style-type: none"> <li>• Reset alarm when process is within range or disable latching</li> <li>• Set output to correct alarm source instance</li> <li>• Set alarm source to correct input instance</li> <li>• Correct cause of sensor input out of alarm range</li> <li>• Set alarm set point to correct trip point</li> <li>• Set alarm to correct type: process, deviation or power</li> <li>• Set digital input function and source instance</li> </ul>
Alarm won't occur	Alarm will not activate output	<ul style="list-style-type: none"> <li>• Alarm silencing is active</li> <li>• Alarm blocking is active</li> <li>• Alarm is set to incorrect output</li> <li>• Alarm is set to incorrect source</li> <li>• Alarm set point is incorrect</li> <li>• Alarm is set to incorrect type</li> </ul>	<ul style="list-style-type: none"> <li>• Disable alarm silencing, if required</li> <li>• Disable alarm blocking, if required</li> <li>• Set output to correct alarm source instance</li> <li>• Set alarm source to correct input instance</li> <li>• Set alarm set point to correct trip point</li> <li>• Set alarm to correct type: process, deviation or power</li> </ul>
Alarm Error <i>ALE 1 ALE 2</i> <i>ALE 3 ALE 4</i> <i>ALE 5 ALE 6</i> <i>ALE 7 ALE 8</i> <i>ALE 9 AL 10</i> <i>AL 11 AL 12</i>	Alarm state cannot be determined due to lack of sensor input	<ul style="list-style-type: none"> <li>• Sensor improperly wired or open</li> <li>• Incorrect setting of sensor type</li> <li>• Calibration corrupt</li> </ul>	<ul style="list-style-type: none"> <li>• Correct wiring or replace sensor</li> <li>• Match setting to sensor used</li> <li>• Check calibration of controller</li> </ul>

Indication	Description	Possible Cause(s)	Corrective Action
Alarm Low <i>ALL1 ALL2</i> <i>ALL3 ALL4</i> <i>ALL5 ALL6</i> <i>ALL7 ALL8</i> <i>ALL9 AL.10</i> <i>AL.11 AL.12</i> <i>AL.13 AL.14</i> <i>AL.15 AL.16</i>	Sensor input below low alarm set point	<ul style="list-style-type: none"> <li>• Temperature is less than alarm set point</li> <li>• Alarm is set to latching and an alarm occurred in the past</li> <li>• Incorrect alarm set point</li> <li>• Incorrect alarm source</li> </ul>	<ul style="list-style-type: none"> <li>• Check cause of under temperature</li> <li>• Clear latched alarm</li> <li>• Establish correct alarm set point</li> <li>• Set alarm source to proper setting</li> </ul>
Alarm High <i>AL.h1 AL.h2</i> <i>AL.h3 AL.h4</i> <i>AL.h5 AL.h6</i> <i>AL.h7 AL.h8</i> <i>AL.h9 AL.10</i> <i>AL.11 AL.12</i> <i>AL.13 AL.14</i> <i>AL.15 AL.16</i>	Sensor input above high alarm set point	<ul style="list-style-type: none"> <li>• Temperature is greater than alarm set point</li> <li>• Alarm is set to latching and an alarm occurred in the past</li> <li>• Incorrect alarm set point</li> <li>• Incorrect alarm source</li> </ul>	<ul style="list-style-type: none"> <li>• Check cause of over temperature</li> <li>• Clear latched alarm</li> <li>• Establish correct alarm set point</li> <li>• Set alarm source to proper setting</li> </ul>
Ambient Error <i>Er.Ab</i>	Sensor does not provide a valid signal to controller	<ul style="list-style-type: none"> <li>• Ambient error - cold junction circuitry not working</li> </ul>	<ul style="list-style-type: none"> <li>• Return to factory for repair</li> </ul>
Error Input <i>Er.i1 Er.i2</i> <i>Er.i3 Er.i4</i> <i>Er.i5 Er.i6</i> <i>Er.i7 Er.i8</i> <i>Er.i9 Er.i10</i> <i>Er.i11 Er.i12</i>	Sensor does not provide a valid signal to controller	<ul style="list-style-type: none"> <li>• Sensor improperly wired or open</li> <li>• Incorrect setting of sensor type</li> <li>• Calibration corrupt</li> </ul>	<ul style="list-style-type: none"> <li>• Correct wiring or replace sensor</li> <li>• Match setting to sensor used</li> <li>• Check calibration of controller</li> </ul>
Limit won't clear or reset	Limit will not clear or reset with keypad or digital input	<ul style="list-style-type: none"> <li>• Sensor input is out of limit set point range</li> <li>• Limit set point is incorrect</li> <li>• Digital input function is incorrect</li> </ul>	<ul style="list-style-type: none"> <li>• Correct cause of sensor input out of limit range</li> <li>• Set limit set point to correct trip point</li> <li>• Set digital input function and source instance</li> </ul>
Limit Error <i>L.i.E1 L.i.E2</i> <i>L.i.E3 L.i.E4</i> <i>L.i.E5 L.i.E6</i> <i>L.i.E7 L.i.E8</i> <i>L.i.E9 L.i.10</i> <i>L.i.11 L.i.12</i>	Limit state cannot be determined due to lack of sensor input, limit will trip	<ul style="list-style-type: none"> <li>• Sensor improperly wired or open</li> <li>• Incorrect setting of sensor type</li> <li>• Calibration corrupt</li> </ul>	<ul style="list-style-type: none"> <li>• Correct wiring or replace sensor</li> <li>• Match setting to sensor used</li> <li>• Check calibration of controller</li> </ul>

Indication	Description	Possible Cause(s)	Corrective Action
Limit Low L .L1 L .L2 L .L3 L .L4 L .L5 L .L6 L .L7 L .L8 L .L9 L .L10 L .L11 L .L12	Sensor input below low limit set point	<ul style="list-style-type: none"> <li>• Temperature is less than limit set point</li> <li>•</li> <li>• Limit outputs latch and require reset</li> <li>• Incorrect alarm set point</li> </ul>	<ul style="list-style-type: none"> <li>• Check cause of under temperature</li> <li>• Clear limit</li> <li>• Establish correct limit set point</li> </ul>
Limit High L .h1 L .h2 L .h3 L .h4 L .h5 L .h6 L .h7 L .h8 L .h9 L .L10 L .L11 L .L12	Sensor input above high limit set point	<ul style="list-style-type: none"> <li>• Temperature is greater than limit set point</li> <li>• Limit outputs latch and require reset</li> <li>• Incorrect alarm set point</li> </ul>	<ul style="list-style-type: none"> <li>• Check cause of over temperature</li> <li>• Clear limit</li> <li>• Establish correct limit set point</li> </ul>
No Display	No display indication or LED illumination	<ul style="list-style-type: none"> <li>• Power to controller is off</li> <li>• Fuse open</li> <li>• Breaker tripped</li> <li>• Safety interlock switch open</li> <li>• Separate system limit control activated</li> <li>• Wiring error</li> <li>• Incorrect voltage to controller</li> </ul>	<ul style="list-style-type: none"> <li>• Turn on power</li> <li>• Replace fuse</li> <li>• Reset breaker</li> <li>• Close interlock switch</li> <li>• Reset limit</li> <li>• Correct wiring issue</li> <li>• Apply correct voltage, check part number</li> </ul>
Remote User Interface (RUI) menus inaccessible	Unable to access <i>SEt</i> , <i>OPEr</i> or <i>FEtY</i> menus or particular prompts in Home Page	<ul style="list-style-type: none"> <li>• Security set to incorrect level</li> <li>• Digital input set to lock-out keypad</li> <li>• Custom parameters incorrect</li> </ul>	<ul style="list-style-type: none"> <li>• Check <i>LoE</i> settings in Factory Page</li> <li>• Change state of digital input</li> <li>• Enter appropriate password in <i>ULoE</i> setting in Factory Page</li> <li>•</li> <li>• Change custom parameters in Factory Page</li> </ul>
RUI value to low uALL	Value too low to be displayed in 4 digit LED display <-1999	<ul style="list-style-type: none"> <li>• Incorrect setup</li> </ul>	<ul style="list-style-type: none"> <li>• Check scaling of source data</li> </ul>

Indication	Description	Possible Cause(s)	Corrective Action
RUI value to high <i>uAL.h</i>	Value to high to be displayed in 4 digit LED display >9999	<ul style="list-style-type: none"> <li>Incorrect setup</li> </ul>	<ul style="list-style-type: none"> <li>Check scaling of source data</li> </ul>

Detection of and Rules Around Abnormal Sensor Conditions	
Inputs	Detection of Abnormal Conditions
Thermocouple	
Shorted	No direct detection, Open loop firmware detection.
Open	Yes, Parasitic pull-up
Reversed	Yes, firmware detection
Current Source	
Shorted	Range limiting only
Open	Range limiting only
Reversed	Range limiting only
Voltage Source	
Open	Range limiting only
Shorted	Range limiting only
Reversed	Range limiting only
RTD	
S1 open	Yes, pulled up.
S3 open	Yes, pulled up.
S1 short to S3	Yes, pulled down to under range.
S1 and S3 open	Yes, S1 pulled up.
Thermistor	
S1 open	Yes, pulled up to sensor over range.
S3 open	Yes, pulled up to sensor over range.
S1 short to S3	Yes, pulled down to sensor under range.
S1 and S3 open	Yes, S1 pulled up to sensor over range.



## RML Specifications

### Line Voltage/Power

- 20.4 to 30.8V $\approx$  (ac/dc), 50/60Hz,  $\pm$ 5 percent
- Power consumption: 7 W, 14VA
- Any external power supply used should comply with a class 2 or SELV rating. (Safety Extra Low Voltage)
- Data retention upon power failure via nonvolatile memory
- Compliant with Semi F47-0200, Figure R1-1 voltage sag requirement

### Available (optional) Power Supplies

- AC/DC Power supply converter 90-264V $\sim$  (ac) to 24V $\equiv$  (dc) volts.
- P/N 0847-0299-0000: 31 W
- P/N 0847-0300-0000: 60 W
- P/N 0847-0301-0000: 91 W

### Environment

- 0 to 149°F (-18 to 65°C) operating temperature
- -40 to 185°F (-40 to 85°C) storage temperature
- 0 to 90 percent RH, non-condensing
- RM modules are considered to be open type equipment needing to be installed in a fire and shock protection enclosure, such as a NEMA Type 1 enclosure; unless all circuit connections are Class 2 or SELV

### Accuracy

- Calibration accuracy and sensor conformity:  $\pm$ 0.1% of span,  $\pm$ 1°C at the calibrated ambient temperature and rated line voltage
- Types R, S, B; 0.2%
- Type T below -50°C; 0.2%
- Calibration ambient temperature at 25°C  $\pm$ 3°C (77°F  $\pm$ 5°F)
- Accuracy span: 540°C (1000°F) min.
- Temperature stability:  $\pm$ 0.1°C/°C ( $\pm$ 0.1°F/°F) rise in ambient max.

### Agency Approvals

- UL<sup>®</sup> Listed to UL<sup>®</sup> 61010-1 File E185611
- UL<sup>®</sup> Reviewed to CSA C22.2 No.61010-1-04
- FM Class 3545 File 3039786 temperature limit switches
- CE - See Declaration of Conformity RoHS and W.E.E.E. compliant

### Serial Communications

- All RM modules ship with isolated standard bus protocol for configuration and communication connection to all other EZ-ZONE products, Modbus RTU is optional.

### Maximum RM System Configuration

- Maximum system capacity (all RM modules) is 16 with one RM Access (RMA) module.

### Maximum Limit Configuration

- Up to 12 loops per module with a maximum of 16 modules

## Mounting

- DIN-rail specification EN50022, 35 x 7.5 mm (1.38 x 0.30 in.)
- Can be DIN-rail mounted or chassis mounted with customer-supplied fasteners

Dimensions		Weight
155.0 mm (6.10 in)	116.08 mm (4.57 in)	Controller: 453.59 g (16 oz.)

## Wiring Termination—Touch-Safe Terminals

- Right angle and front screw type terminal blocks (slots A, B, D, E)
  - Input, power and controller output terminals, touch-safe removable 12 to 30 AWG
- Wire strip length 7.6 mm (0.30 in.)
- Torque 0.56 Nm (5.0 lb.-in.) right angle, 0.5 Nm (4.51 lb-in) front terminal block
- Dimensional Drawing
- Use solid or stranded copper conductors only

Connector	Dimension "A" (mm/in.)
Standard	148 (5.80)
Straight	155 (6.10)

---

## Optional Accessories

### Remote User Interface (RUI)

- 1/16 DIN
- Dual 4 digit, 7-segment LED displays
- Keys: Advance, infinity, up, down keys, plus an EZ-KEY programmable function key
- Typical display update rate 1Hz

### EZ-ZONE RML Product Documentation

- Watlow Support Tools CD, P/N 0601-0001-0000

### Universal Input

- Thermocouple, grounded or ungrounded sensors
  - >20M $\Omega$  input impedance
- Max. 2K $\Omega$  source resistance
- 3 $\mu$ A open sensor detection
- RTD 2- wire, platinum, 100 $\Omega$  and 1000 $\Omega$  @ 0 $^{\circ}$ C (32 $^{\circ}$ F) calibration to DIN curve (0.00385  $\Omega/\Omega/^{\circ}$ C)
- Process, 0-20mA @100 $\Omega$ , or 0-10V $\overline{=}$  (dc) @ 20k $\Omega$  input impedance; scalable, 0-50mV

#### *Voltage Input Ranges*

- Accuracy  $\pm 10$ mV  $\pm 1$  LSD at standard conditions
- Temperature stability  $\pm 100$  PPM/ $^{\circ}$ C maximum

#### *Milliamp Input Ranges*

- Accuracy  $\pm 20$  $\mu$ A  $\pm 1$  LSD at standard conditions
- Temperature stability  $\pm 100$  PPM/ $^{\circ}$ C maximum

#### *Resolution Input Ranges*

- 0 to 10V: 200  $\mu$ V nominal
- 0 to 20 mA: 0.5 mA nominal

- Potentiometer: 0 to 1,200Ω
- Inverse scaling
- Response time: 1 second max., accuracy ±1mA typical

Input Type	Max Error @ 25 Deg C	Accuracy Range Low	Accuracy Range High	Units
J	±1.75	0	750	Deg C
K	±2.45	-200	1250	Deg C
T	±1.55	-200	350	Deg C
N	±2.25	0	1250	Deg C
E	±2.10	-200	900	Deg C
R	±3.9	0	1450	Deg C
S	±3.9	0	1450	Deg C
B	±2.66	870	1700	Deg C
C	±3.32	0	2315	Deg C
D	±3.32	0	2315	Deg C
F (PTII)	±2.34	0	1343	Deg C
RTD, 100 ohm	±2.00	-200	800	Deg C
RTD, 1000 ohm	±2.00	-200	800	DegC
mV	±0.05	-50	50	mV
Volts	±0.01	0	10	Volts
mAdc	±0.02	0	20	mAmps DC
mAac	±5	0	50	mAmps AC
Potentiometer, 1K range	±1	0	1000	Ohms
Resistance, 5K range	±5	0	5000	Ohms
Resistance, 10K range	±10	0	10000	Ohms
Resistance, 20K range	±20	0	20000	Ohms
Resistance, 40K range	±40	0	40000	Ohms

Operating Range			
Input Type	Range Low	Range High	Units
J	-210	1200	Deg C
K	-270	1371	Deg C
T	-270	400	Deg C
N	-270	1300	Deg C
E	-270	1000	Deg C
R	-50	1767	Deg C
S	-50	1767	Deg C
B	0	1816	Deg C
C	0	2315	Deg C
D	0	2315	Deg C
F (PTII)	0	1343	Deg C
RTD (100 ohm)	-200	800	Deg C
RTD (1000 ohm)	-200	800	Deg C
mV	0	50	mV
Volts	0	10	Volts
mAdc	0	20	mAmps DC
mAac	0	50	mAmps AC
Potentiometer, 1K range	0	1200	Ohms
Resistance, 5K range	0	5000	Ohms
Resistance, 10K range	0	10000	Ohms
Resistance, 20K range	0	20000	Ohms
Resistance, 40K range	0	40000	Ohms

Thermistor Input				
Input Type	Max Error @ 25 Deg C	Accuracy Range Low	Accuracy Range High	Units
Thermistor, 5K range	±5	0	5000	Ohms
Thermistor, 10K range	±10	0	10000	Ohms
Thermistor, 20K range	±20	0	20000	Ohms
Thermistor, 40K range	±40	0	40000	Ohms

- 0 to 40KΩ, 0 to 20KΩ, 0 to 10KΩ, 0 to 5KΩ
- 2.252KΩ and 10KΩ base at 25°C
- Linearization curves built in
- Third party Thermistor compatibility requirements

Base R @ 25C	Alpha Techniques	Beta THERM	YSI	Thermistor Curve
2.252K	Curve A	2.2K3A	004	A
10K	Curve A	10K3A	016	B
10K	Curve C	10K4A	006	C

## Digital Input

- Update rate 10Hz
- DC voltage
  - Max. input 36V at 3mA
  - Min. high state 3V at 0.25mA
  - Max. low state 2V

## Dry Contact

- Update rate 10Hz
- Min. open resistance 10K $\Omega$
- Max. closed resistance 50 $\Omega$

## Output Hardware

- Electromechanical relay, Form A, 24 to 240VAC or 30VDC max., 5A resistive load, 100,000 cycles at rated load, 120/240 @ 125 VA or 24VAC @ 25VA pilot duty
- Electromechanical relay, Form C, 24 to 240VAC or 30VDC max., 5A resistive load, 100,000 cycles at rated load, 120/240 @ 125 VA or 24VAC @ 25VA pilot duty
- Digital outputs
  - Update rate 10Hz
  - Switched DC
    - Output voltage 20V $\approx$  (dc)
    - Max. supply current source 40mA at 20V $\approx$  (dc)
  - Open Collector
    - Switched voltage max.: 32V $\approx$  (dc)
    - Max. switched current per output: 1.5A
    - Max. switched current for all 6 outputs combined: 8A
- 0 to 10V $\approx$  (dc) into a min. 1,000 $\Omega$  load
- 0 to 20mA into max. 800 $\Omega$  load

## Programmable Application Blocks

**Actions (events)** - 16 total

**Alarms** - 16 total

**Limit Loops** - 12 total

**Compare** - 16 total

Off, greater than, less than, equal, not equal, greater than or equal, less than or equal

**Counters** - 16 total

Counts up or down loads, predetermined value on load signal. Output is active when count value equals predetermined target value

**Logic** - 16 total

Off, and, nand, or, nor, equal, not equal, Latch

**Linearization** - 16 total

Interpolated or stepped relationship

**Math** - 16 total

Off, average, process scale, deviation scale, differential (subtraction), ratio (divide), add, multiply, absolute difference, min., max., square root, sample and hold

**Timers - 16 total**

*On Pulse* produces output of fixed time on active edge of timer run signal

*Delay* output is a delayed start of timer run, off at same time

*One Shot* oven timer

*Retentive* measures timer run signal, output on when accumulated time exceeds target

**Variable - 16 total**

User value for digital or analog variable

**Note:**

These specifications are subject to change without prior notice.

# RML Ordering Information

Limit module requires a Class 2 or SELV power supply 20.4 to 30.8 V ~(ac) / —(dc), communication port provided for configuration with EZ-ZONE Configurator software.

## Code Number

①② EZ-ZONE Rail Mount	③ Limit Module	④ Connector Style/ Custom Product	⑤ Slot A	⑥ Slot B	⑦ Slot D	⑧ Slot E	⑨ Future Options	⑩ Enhanced Options	⑪⑫ Additional Options	
<b>RM</b>	<b>L</b>		-				-	<b>A</b>		<b>AA</b>

### Connector Style/Custom Product - Digit ④

- A = Right angle screw connector (standard)
- F = Front screw connector
- S = Custom

### Slot A - Digit ⑤

- 5 = 4 Universal inputs (t/c, 2-wire RTD, 0-10Vdc, 0-20mA) with 4 limit control loops
- 6 = 4 Thermistor inputs with 4 limit control loops

### Slot B - Digit ⑥

- A = None
- 5 = 4 Universal inputs (t/c, 2-wire RTD, 0-10Vdc, 0-20mA) with 4 limit control loops
- 6 = 4 Thermistor inputs with 4 limit control loops

### Slot D - Digit ⑦

- A = None
- 5 = 4 Universal inputs (t/c, 2-wire RTD, 0-10Vdc, 0-20mA) with 4 limit control loops
- 6 = 4 Thermistor inputs with 4 limit control loops
- J = 4 Mechanical relay 5A, Form A
- C = 6 Digital I/O

### Slot E - Digit ⑧

- J = 4 Mechanical relay 5A, Form A
- B = 1 Digital input and 1 Form C, 1 Form A Mechanical relays

### Future Options - Digit ⑨

- A = Standard

### Enhanced Options - Digit ⑩

- A = Standard Bus
- 1 = Standard Bus and Modbus RTU 485 (selectable via switch)

### Additional Options - Digits ⑪ ⑫

#### Firmware, Overlays, Parameter Settings

- AA = Standard
- AB = Replacement connectors hardware only, for the entered model number
- XX = Custom (consult factory)

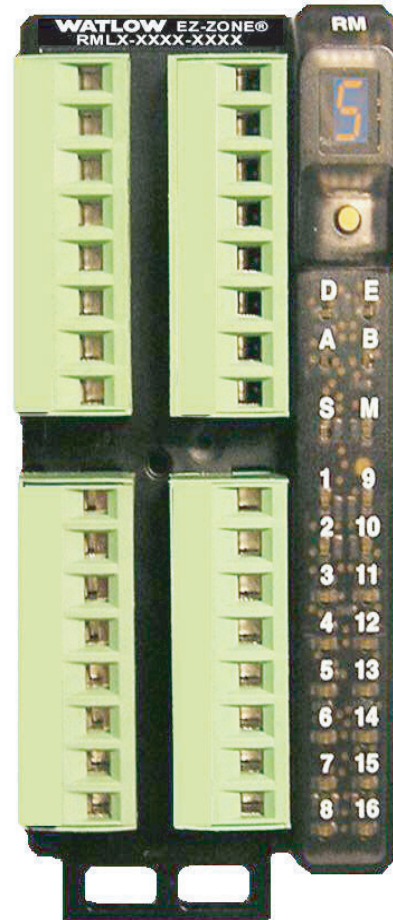

Watlow®, EZ-ZONE® and TRU-TUNE® are registered trademarks of Watlow Electric Manufacturing Company.

UL® is a registered trademark of Underwriter's Laboratories, Inc.

Modbus® is a registered trademark of Schneider Automation Incorporated.

DeviceNet™ and EtherNet/IP™ are trademarks of Open DeviceNet Vendors Association.

# Declaration of Conformity

## EZ Zone Series RM

WATLOW Electric Manufacturing Company  
1241 Bundy Blvd.  
Winona, MN 55987 USA



ISO 9001 since 1996.

Declares that the following Series RM (Rail Mount) products:

Model Numbers: **RM** followed by additional letters or numbers describing use of up to four module options of various inputs and outputs or communications.  
Classification: Temperature control, Installation Category II, Pollution degree 2  
Voltage and Frequency: SELV 24 to 28 V $\approx$  ac 50/60 Hz or dc  
Power Consumption: RMA models 4 Watts, any other RM model 7 Watts  
Environmental Rating: IP20

Meet the essential requirements of the following European Union Directives by using the relevant standards show below to indicate compliance.

### **2004/108/EC Electromagnetic Compatibility Directive**

<b>EN 61326-1</b>	<b>2013</b>	<b>Electrical equipment for measurement, control and laboratory use – EMC requirements, Industrial Immunity, Class A Emissions (Not for use in a Class B environment without additional filtering).</b>
EN 61000-4-2	2009	Electrostatic Discharge Immunity
EN 61000-4-3	2010	Radiated Field Immunity
EN 61000-4-4	2012	Electrical Fast-Transient / Burst Immunity
EN 61000-4-5	2006	Surge Immunity (Reviewed to IEC 61000-4-5 2014)
EN 61000-4-6	2014	Conducted Immunity
EN 61000-4-11	2004	Voltage Dips, Short Interruptions and Voltage Variations Immunity
EN 61000-3-2	2009	Harmonic Current Emissions (Reviewed to IEC 61000-3-2 2014)
EN 61000-3-3 <sup>1</sup>	2013	Voltage Fluctuations and Flicker
SEMI F47	2000	Specification for Semiconductor Sag Immunity Figure R1-1

<sup>1</sup>NOTE: To comply with flicker requirements cycle time may need to be up to 160 seconds if load current is at 15A, or the maximum source impedance needs to be < 0.13 $\Omega$ . Control power input of RM models comply with 61000-3-3 requirements.

### **2006/95/EC Low-Voltage Directive**

<b>EN 61010-1</b>	<b>2011</b>	<b>Safety Requirements of electrical equipment for measurement, control and laboratory use. Part 1: General requirements</b>
-------------------	-------------	--

### **Compliant with 2011/65/EU RoHS Directive**

**Per 2012/19/EU W.E.E.E Directive  Please Recycle Properly**

Joe Millanes  
Name of Authorized Representative

Winona, Minnesota, USA  
Place of Issue

Director of Operations  
Title of Authorized Representative

September 2014  
Date of Issue

  
Signature of Authorized Representative



# How to Reach Us

## Corporate Headquarters

Watlow Electric Manufacturing Company  
12001 Lackland Road  
St. Louis, MO 63146  
Sales: 1-800-WATLOW2  
Manufacturing Support:  
1-800-4WATLOW  
Email: [info@watlow.com](mailto:info@watlow.com)  
Website: [www.watlow.com](http://www.watlow.com)  
From outside the USA and Canada:  
Tel: +1 (314) 878-4600  
Fax: +1 (314) 878-6814

## Latin America

Watlow de México S.A. de C.V.  
Av. Fundición No. 5  
Col. Parques Industriales  
Querétaro, Qro. CP-76130  
Mexico  
Tel: +52 442 217-6235  
Fax: +52 442 217-6403

## Europe

Watlow France  
Tour d'Asnières.  
4 Avenue Laurent Cély  
92600 Asnières sur Seine  
France  
Tél: + 33 (0)1 41 32 79 70  
Télécopie: + 33(0)1 47 33 36 57  
Email: [info@watlow.fr](mailto:info@watlow.fr)  
Website: [www.watlow.fr](http://www.watlow.fr)

Watlow GmbH  
Postfach 11 65, Lauchwasenstr. 1  
D-76709 Kronau  
Germany  
Tel: +49 (0) 7253 9400-0  
Fax: +49 (0) 7253 9400-900  
Email: [info@watlow.de](mailto:info@watlow.de)  
Website: [www.watlow.de](http://www.watlow.de)

Watlow Italy S.r.l.  
Viale Italia 52/54  
20094 Corsico MI  
Italy  
Tel: +39 024588841  
Fax: +39 0245869954  
Email: [italyinfo@watlow.com](mailto:italyinfo@watlow.com)  
Website: [www.watlow.it](http://www.watlow.it)

Watlow Ibérica, S.L.U.  
C/Marte 12, Posterior, Local 9  
E-28850 Torrejón de Ardoz  
Madrid - Spain  
T. +34 91 675 12 92  
F. +34 91 648 73 80  
Email: [info@watlow.es](mailto:info@watlow.es)  
Website: [www.watlow.es](http://www.watlow.es)

Watlow UK Ltd.  
Linby Industrial Estate  
Linby, Nottingham, NG15 8AA  
United Kingdom  
Telephone: (0) 115 964 0777  
Fax: (0) 115 964 0071  
Email: [info@watlow.co.uk](mailto:info@watlow.co.uk)  
Website: [www.watlow.co.uk](http://www.watlow.co.uk)  
From outside The United Kingdom:  
Tel: +44 115 964 0777  
Fax: +44 115 964 0071

## Asia and Pacific

Watlow Singapore Pte Ltd.  
16 Ayer Rajah Crescent,  
#06-03/04,  
Singapore 139965  
Tel: +65 6773 9488 Fax: +65 6778 0323  
Email: [info@watlow.com.sg](mailto:info@watlow.com.sg) Website: [www.watlow.com.sg](http://www.watlow.com.sg)

Watlow Australia Pty., Ltd.  
4/57 Sharps Road  
Tullamarine, VIC 3043  
Australia  
Tel: +61 3 9335 6449  
Fax: +61 3 9330 3566  
Website: [www.watlow.com](http://www.watlow.com)

Watlow Electric Manufacturing Company (Shanghai) Co. Ltd.  
Room 501, Building 10, KIC Plaza  
290 Songhu Road, Yangpu District  
Shanghai, China 200433  
China  
Phone  
Local: 4006 Watlow (4006 928569)  
International: +86 21 3381 0188  
Fax: +86 21 6106 1423  
Email: [info@watlow.cn](mailto:info@watlow.cn)  
Website: [www.watlow.cn](http://www.watlow.cn)

ワトロー ジャパン株式会社  
〒101-0047 東京都千代田区内神田1-14-4

四国ビル別館9階  
Tel: 03-3518-6630 Fax: 03-3518-6632  
Email: [infoj@watlow.com](mailto:infoj@watlow.com) Website: [www.watlow.co.jp](http://www.watlow.co.jp)

Watlow Japan Ltd.  
1-14-4 Uchikanda, Chiyoda-Ku  
Tokyo 101-0047  
Japan  
Tel: +81-3-3518-6630 Fax: +81-3-3518-6632  
Email: [infoj@watlow.com](mailto:infoj@watlow.com) Website: [www.watlow.co.jp](http://www.watlow.co.jp)

Watlow Korea Co., Ltd.  
#1406, E&C Dream Tower, 46, Yangpyeongdong-3ga  
Yeongdeungpo-gu, Seoul 150-103  
Republic of Korea  
Tel: +82 (2) 2628-5770 Fax: +82 (2) 2628-5771  
Website: [www.watlow.co.kr](http://www.watlow.co.kr)

Watlow Malaysia Sdn Bhd  
1F-17, IOI Business Park  
No.1, Persiaran Puchong Jaya Selatan  
Bandar Puchong Jaya  
47100 Puchong, Selangor D.E.  
Malaysia  
Tel: +60 3 8076 8745 Fax: +60 3 8076 7186  
Email: [vlee@watlow.com](mailto:vlee@watlow.com)  
Website: [www.watlow.com](http://www.watlow.com)

瓦特龍電機股份有限公司  
80143 高雄市前金區七賢二路189號 10樓之一  
電話: 07-2885168 傳真: 07-2885568

Watlow Electric Taiwan Corporation  
10F-1 No.189 Chi-Shen 2nd Road Kaohsiung 80143  
Taiwan  
Tel: +886-7-2885168 Fax: +886-7-2885568

## Your Authorized Watlow Distributor

