



EZ-ZONE<sup>®</sup> Profibus Technical Reference





## Contents

1. EZ-ZONE <sup>®</sup> Profibus .....	3
2. Creating a GSD File .....	5
3. Installing a GSD File .....	9
4. Profibus parameters in the product .....	10
5. Profibus Status LED .....	11
6. Troubleshooting .....	11
7. Example project .....	11
8. Conclusion .....	12
9. Appendix .....	12



## Abstract

The following information describes the use of Profibus DP slaves as it relates to Watlow EZ-ZONE<sup>®</sup> Family. This document talks about installing a EZ-ZONE<sup>®</sup> Profibus DP slave node into a Profibus network, creating customized GSD files, accessing Profibus specific parameters in the product, trouble shooting, and examples. For more information on Profibus, you can refer to PROFI Trade Organization ([www.profibus.com](http://www.profibus.com)).

## 1. EZ-ZONE<sup>®</sup> Profibus

EZ-ZONE<sup>®</sup> Profibus Module is a DP Slave and supports both DPV0 and DPV1. The IDENT number for EZ-ZONE<sup>®</sup> Profibus products is **0C70** (hex). All EZ-ZONE<sup>®</sup> products can be used in a Profibus network using an EZ-ZONE<sup>®</sup> RUI or RMA with Profibus Option. Additionally, most Panel Mount (PM) models are available with Profibus option. This allows PMs to be directly integrated into a Profibus network without an RUI or RMA.

Following table shows how EZ-ZONE products can be integrated into a Profibus network.

EZ-ZONE <sup>®</sup> Product	Directly	Using a RUI	Using a RMA
ST		X	
PM 1/16, 1/8, 1/4 DIN	X	X	
PM 1/32 DIN		X	
PM Express		X	
RM		X	X

**Table 1:** Integrating EZ-ZONE<sup>®</sup> products into a Profibus Network

A PM with the built-in Profibus option acts as a Profibus DP slave in the network (Figure 1a). Therefore, up to 125 PMs can be placed in the same Profibus network. Other products require the use of a RUI Gateway or RMA to connect to a Profibus network. Each RUI or RMA connects up to 16 devices into the network. In this case, the RUI or RMA appears as a Profibus DP slave Node in the network and works as a gateway for the rest of the devices. So for example, if you need to access 32 STs over a Profibus network, you can use 2 RUIs with Profibus option, where each RUI is connected to 16 STs and only the 2 RUIs would be visible in the Profibus network (See Figure 1b). In this way up to 2000 Controllers can be added to a single Profibus network using 16 RUIs or RMAs.

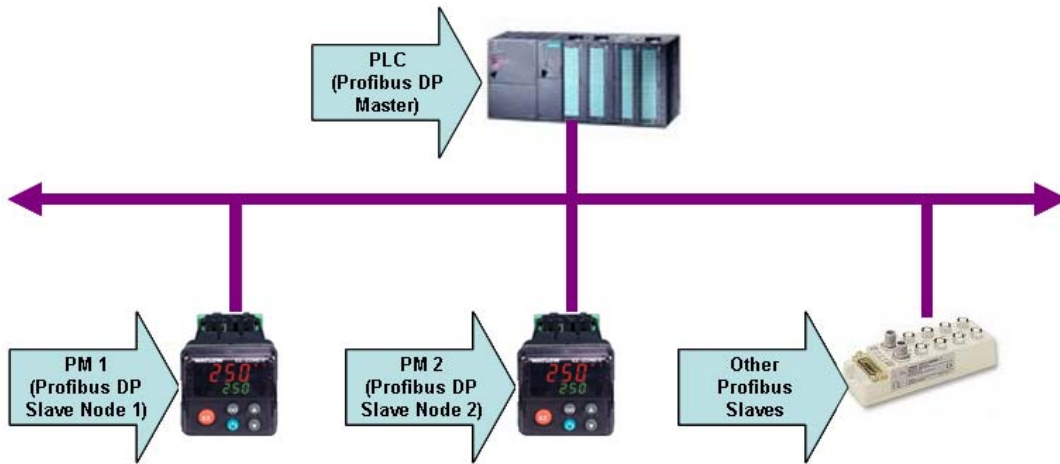

**Figure 1a:** Wiring 2 PM with Profibus option into a Profibus Network.

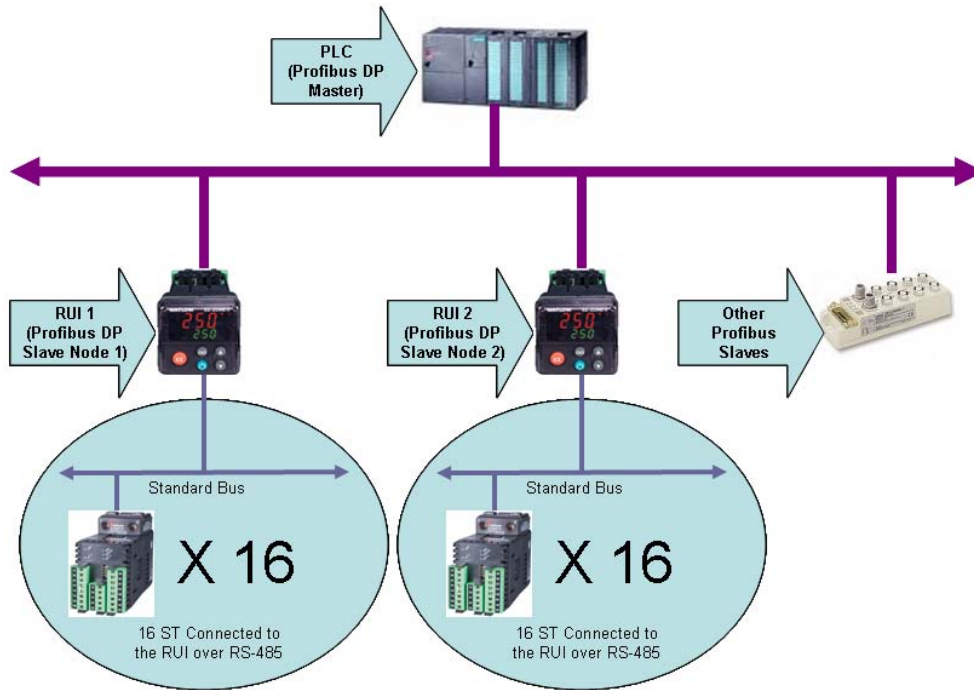

**Figure 1b:** Wiring 32 STs into a Profibus Network using RUIs



Each EZ-ZONE<sup>®</sup> Profibus node supports up to 244 bytes of data in each direction for cyclic communication. So, in Data-Exchange mode, you can read up to 244 bytes of input data from the device(s) and write up to 244 bytes of output data to the device(s). The content of the cyclic data is dictated by the GSD file.

## 2. Creating a GSD File

To allow users to better customize a GSD file, Watlow provides “EZ-ZONE<sup>®</sup> GSD Editor”, software for creating custom GSD files. To create a GSD file using EZ-ZONE<sup>®</sup> GSD Editor:

1. Download and Install EZ-ZONE<sup>®</sup> GSD Editor from [www.watlow.com](http://www.watlow.com)
2. Start EZ-ZONE<sup>®</sup> GSD Editor
3. This will prompt you to select an EZ-ZONE<sup>®</sup> Profibus device. In this example, we are using a PM. So, we selected PM and clicked on Create New.

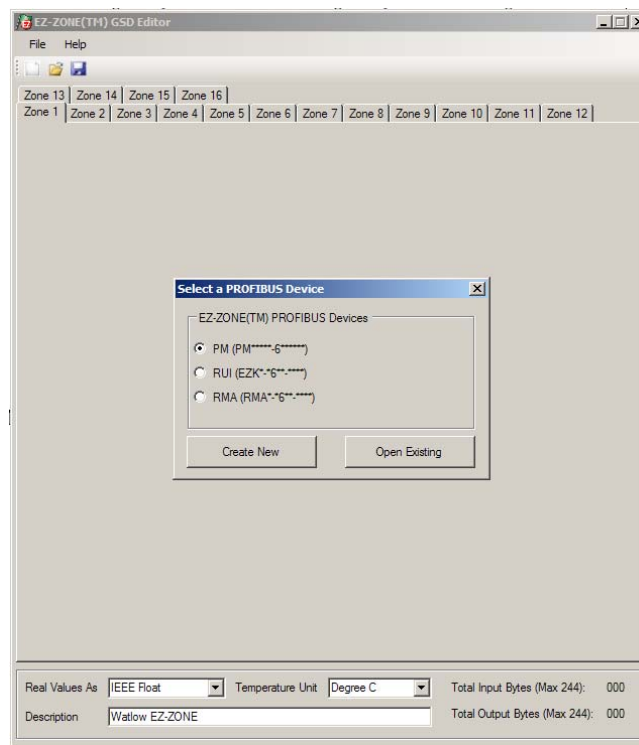

**Figure 2a:** GSD Editor Startup Window

4. Once a product is selected, it will give you a list of data points that are available for this product. When a PM is selected, it will give you data points only for a single PM (Figure 2b) as PM works as a single Profibus DP Slave Node. However, if you select RUI or RMA, it will allow you to pick data points for up to 16 zones (Figure 2c) as RUI or RMA works like a gateway.

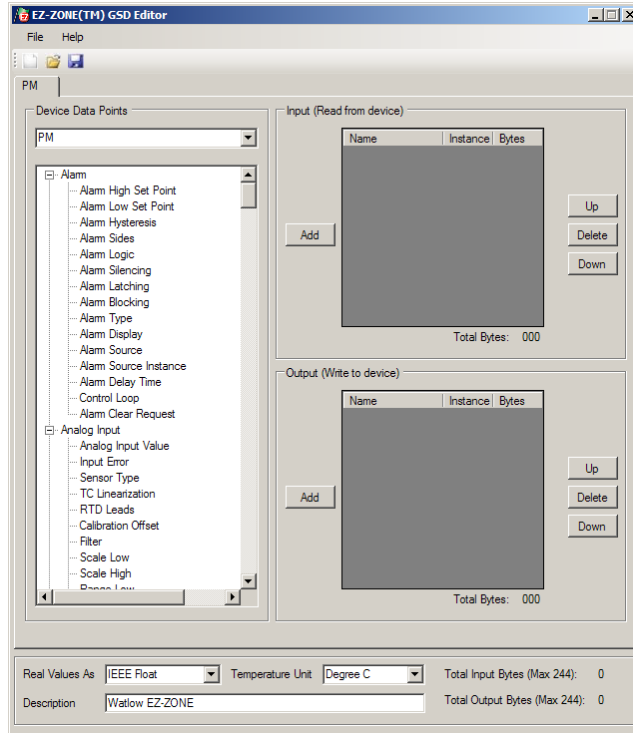
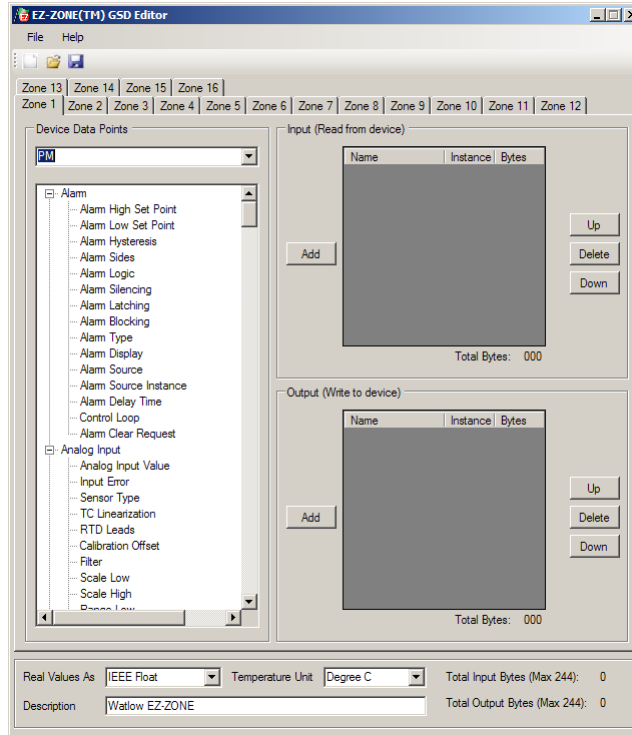

Figure 2b: Selecting data points for a PM Profibus node



**Figure 2c:** Selecting data points for a RUI/RMA Profibus gateway



The GSD editor allows the following:

1. Selecting data points to read and write during cyclic communication.
2. Selecting data type for real values. By default, real values are 4 bytes. EZ-ZONE<sup>®</sup> products allow conversion of real values to integers or integers with tenth precision so that each value takes only 2 bytes. This is ideal when an application doesn't require high precision and/or there is memory constraint.
3. Selecting the Temperature Unit (Celsius or Fahrenheit) for input and output data. This parameter is also editable via network configuration tools (Figure 2d).
4. Entering a description for the GSD file
5. Printing I/O Map
6. Modifying a saved GSD file created earlier.

For details on any of the above items, go to Help → How to create a GSD file in EZ-ZONE<sup>®</sup> GSD Editor.

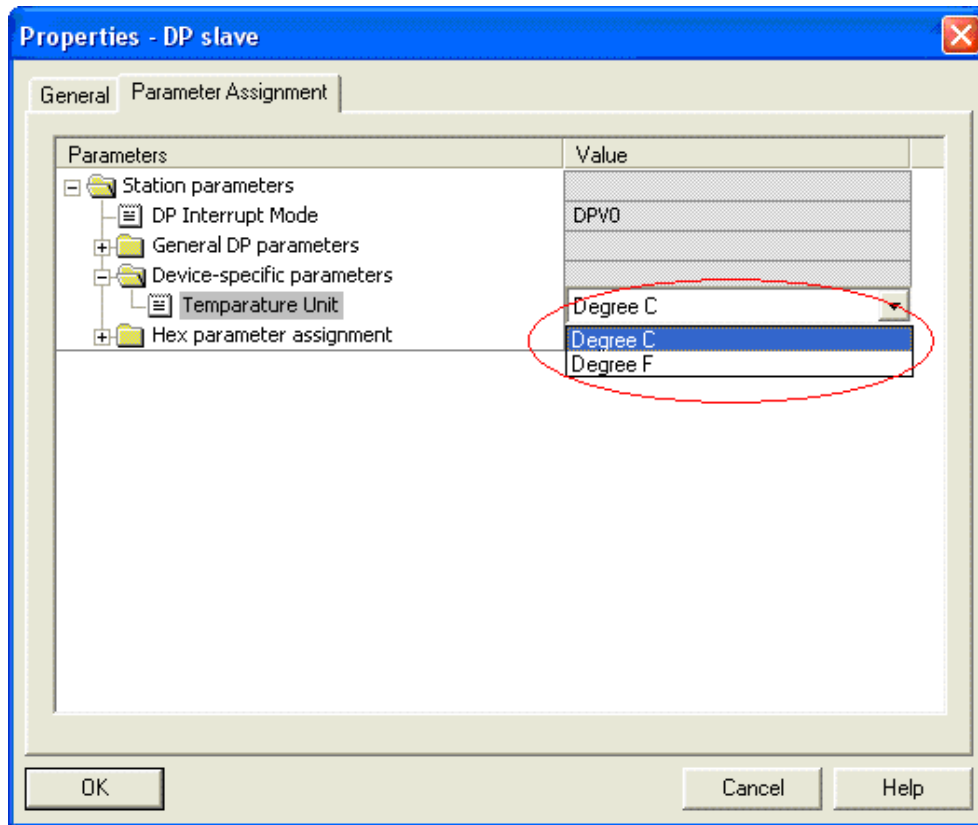

**Figure 2d:** Changing Temperature Unit for EZ-ZONE<sup>®</sup> Profibus node in SIMATIC HW Config.





### 3. Installing a GSD File

Once a GSD file is created, we can use that file with any Profibus PLC and network configuration tool to add an EZ-ZONE<sup>®</sup> Profibus device. In this example we are using a Siemens S7-300DP PLC and SIMATIC Manager.

In order to use the EZ-ZONE<sup>®</sup> Profibus node, we must first add the GSD file into SIMATIC manager's library of GSD files. To install the GSD file:

1. Open the relevant project.
2. Go to "HW Config" of the project
3. Go to Options → Install GSD File (Figure 3a) and follow the on screen instructions.
4. Once a GSD file is installed, it will appear under PROFIBUS DP/Additional Field Devices/Closed-loop controllers in the GSD library (Figure 3b)
5. Usually two configurations show up under the device. Select the configuration with the name, "PM", "RUI", or "RM".

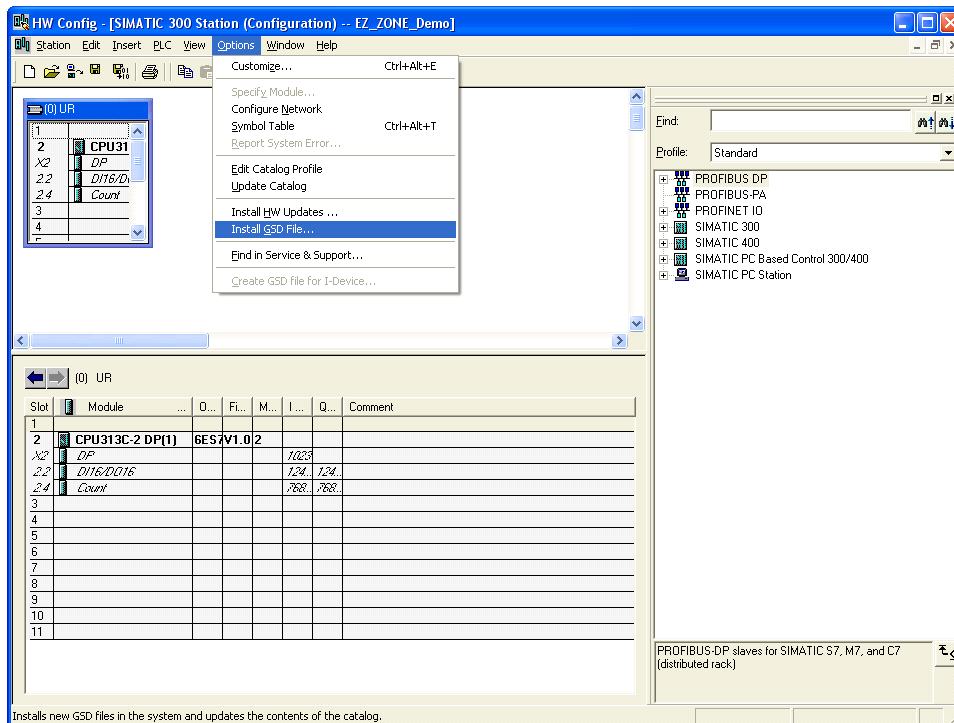

Figure 3a: Installing a GSD File

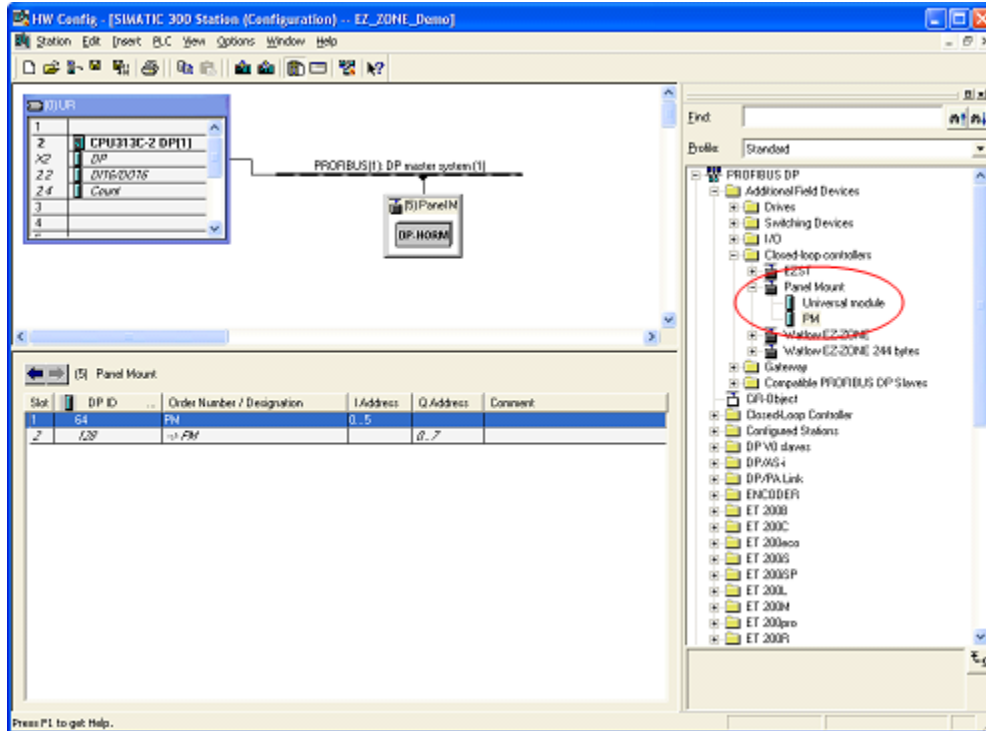

Figure 3b: Location of GSD File

#### 4. Profibus Parameters in the Product

The product has three Profibus parameters:

1. **Address:** This is the Profibus address of the node. The range of the address is 1 to 126.
2. **Address Lock:** This can be set to either “Yes” or “No”. When set to yes, the Profibus address cannot be changed over Profibus.
3. **Status:** This is a read-only parameter. The values can be either “Ready” or “Running”. When the unit is in Data-Exchange mode, this parameter reads “Running” and it reads “Ready” at all other times.

These parameters are located in Setup Page → Communication Menu → Instance 2. They can be accessed either via front panel or via EZ-ZONE® Configurator PC Software only. For details on how to access parameters using the front panel, refer to the controller user’s manual.



## 5. Profibus Status LED

In addition to the “Status” parameter, the Profibus module also has a bi-color Status LED. The LED changes color and blinking pattern according to the DPV0 status. The LED can be decoded in the following manner:

LED Color/Patter	Status
Solid Red	Waiting for Profibus network detection
Blinking Red	Profibus network detected
Green	In Data-Exchange mode

**Table 2:** Profibus Status LED

## 6. Troubleshooting

Once the GSD file is added in the project and the unit is configured with the right Profibus address, the unit should enter Data-Exchange mode upon being parameterized and configured by the Profibus Master. The most common reason for EZ-ZONE<sup>®</sup> Profibus Module to not enter Data-Exchange mode is having one or more non-existent data points in the GSD File. For example, if you include the parameter “Process Value 2” in the GSD file, but the target unit does not have “Process Value 2”, then you will receive a “config error” and the unit will not enter Data-Exchange mode.

## 7. Example project

An example Profibus project is available online for your convenience. The project uses the following tools:

Product	Description
Watlow EZ-ZONE <sup>®</sup> PM	A 1/16 DIN Panel Mount Controller with the Profibus option.
EZ-ZONE <sup>®</sup> GSD Editor	Free Software from Watlow for creating Customized GSD Files. Available from Download Center at <a href="http://www.watlow.com/literature/prodtechinfo/files/software/ezgsdeditorinstallera.exe">http://www.watlow.com/literature/prodtechinfo/files/software/ezgsdeditorinstallera.exe</a>
CPU313-2DP	Siemens PLC with Profibus DP Option
STEP 7	Software for CPU313-2DP PLC

**Table 3:** List of products used in this example

This example project can be downloaded from <http://www.watlow.com/literature/prodtechinfo/files/controllers/ez-zone%20profibus%20demo%20project.zip>



## 8. Conclusion

This document demonstrates how any EZ-ZONE® products can be easily integrated into a Profibus DP network. This is a supplement to the product user's manual and software available online. Should you have any question or comments, please contact us at the following address:

*Watlow  
1241 Bundy Blvd  
Winona, MN 55987  
USA  
Telephone (507) 494-5656*

## 9. Appendix

**EZ-ZONE®:** Integrated Controller Product family consisting of EZ-ZONE® PM, EZ-ZONE PM EXPRESS, EZ-ZONE® ST and EZ-ZONE® RM.

**EZ-ZONE® GSD Editor:** Free software provided by Watlow for creating customized GSD files. This can be downloaded from <http://www.watlow.com/literature/prodtechinfo/files/software/ezgsdeditorinstallera.exe>

**Profibus Network Configuration Tool:** Software often provided with Profibus DP Master for configuring Profibus networks. Ex: SIMATIC Manager.